

User Manual 19" LCD



AP-19 / HAP-19

Aluminum front bezel



NAP-19 / HNAP-19

Front NEMA4 / IP65



DP-19 / HDP-19

Aluminum Front Panel



OP-19 / HOP-19

Universal Open Frame



REACH

Designed and manufactured by Austin Hughes

Legal Information

First English printing, November 2020

Information in this document has been carefully checked for accuracy; however, no guarantee is given to the correctness of the contents. The information in this document is subject to change without notice. We are not liable for any injury or loss that results from the use of this equipment.

Safety Instructions

Please read all of these instructions carefully before you use the device. Save this manual for future reference.

- Unplug equipment before cleaning. Don't use liquid or spray detergent; use a moist cloth.
- Keep equipment away from excessive humidity and heat. Preferably, keep it in an air-conditioned environment with temperatures not exceeding 40° Celsius (104° Fahrenheit).
- When installing, place the equipment on a sturdy, level surface to prevent it from accidentally falling and causing damage to other equipment or injury to persons nearby.
- When the equipment is in an open position, do not cover, block or in any way obstruct the gap between it and the power supply. Proper air convection is necessary to keep it from overheating.
- Arrange the equipment's power cord in such a way that others won't trip or fall over it.
- If you are using a power cord that didn't ship with the equipment, ensure that it is rated for the voltage and current labeled on the equipment's electrical ratings label. The voltage rating on the cord should be higher than the one listed on the equipment's ratings label.
- Observe all precautions and warnings attached to the equipment.
- If you don't intend on using the equipment for a long time, disconnect it from the power outlet to prevent being damaged by transient over-voltage.
- Keep all liquids away from the equipment to minimize the risk of accidental spillage. Liquid spilled on to the power supply or on other hardware may cause damage, fire or electrical shock.
- Only qualified service personnel should open the chassis. Opening it yourself could damage the equipment and invalidate its warranty.
- If any part of the equipment becomes damaged or stops functioning, have it checked by qualified service personnel.

What the warranty does not cover

- Any product, on which the serial number has been defaced, modified or removed.
- Damage, deterioration or malfunction resulting from:
 - Accident, misuse, neglect, fire, water, lightning, or other acts of nature, unauthorized product modification, or failure to follow instructions supplied with the product.
 - Repair or attempted repair by anyone not authorized by us.
 - Any damage of the product due to shipment.
 - Removal or installation of the product.
 - Causes external to the product, such as electric power fluctuation or failure.
 - Use of supplies or parts not meeting our specifications.
 - Normal wear and tear.
 - Any other causes which does not relate to a product defect.
- Removal, installation, and set-up service charges.

Regulatory Notices Federal Communications Commission (FCC)

This equipment has been tested and found to comply with the limits for a Class B digital device, pursuant to Part 15 of the FCC rules. These limits are designed to provide reasonable protection against harmful interference in a residential installation.

Any changes or modifications made to this equipment may void the user's authority to operate this equipment. This equipment generates, uses, and can radiate radio frequency energy and, if not installed and used in accordance with the instructions, may cause harmful interference to radio communications.

However, there is no guarantee that interference will not occur in a particular installation. If this equipment does cause harmful interference to radio or television reception, which can be determined by turning the equipment off and on, the user is encouraged to try to correct the interference by one or more of the following measures:

- Re-position or relocate the receiving antenna.
- Increase the separation between the equipment and receiver.
- Connect the equipment into an outlet on a circuit different from that to which the receiver is connected.

Contents

< Part. 1 > AP-19 / NAP-19 / HAP-19 / HNAP-19

- 1.1 Package Content P.1
- 1.2 Structure Diagram & Dimension P.2 - 3
- 1.3 Mounting Hardware & Installation P.4

< Part. 2 > DP-19 / HDP-19

- 2.1 Package Content P.5
- 2.2 Structure Diagram & Dimension P.6 - 7
- 2.3 Mounting Hardware & Installation P.8

< Part. 3 > OP-19 / HOP-19

- 3.1 Package Content P.9
- 3.2 Structure Diagram & Dimension P.10 - 11
- 3.3 Mounting Hardware & Installation P.12

< Part. 4 > Specifications / OSD

- 4.1 Product Specifications P.13 - 14
- 4.2 On-screen Display Operation (OSD) P.15

< Part. 5 > Options

- 5.1 Option Table P.16
- 5.2 3G / HD / SD-**SDI** Broadcast-grade input P.17
- 5.3 **MCS** Multi-display control solution P.18
- 5.4 **AV2.2D** Upgrade : DVI-D, S-Video + BNC & Audio
AV2.2H Upgrade : HDMI, S-Video + BNC & Audio
AV3.0 Upgrade : HDMI, DVI-D, S-Video + BNC & Audio P.19
- 5.5 Projected Capacitive (10-point touch)
Resistive / Capacitive (1-point touch) P.20 - 21
- 5.6 DC Power : 12V / 24V / 48V / 125V P.22
- 5.7 MIL-type or lockable connector P.23
- 5.8 TV (Analog) P.24 - 25
- 5.9 Options for Sunlight Readable : Auto Dimming P.26

< Part. 6 > Ultraview Family

- 6.1 19" P.27

Before Installation

- It is very important to mount the equipment in a suitable cabinet or on a stable surface.
- Make sure the place has a good ventilation, is out of direct sunlight, away from sources of excessive dust, dirt, heat, water, moisture and vibration.

Unpacking

The equipment comes with the standard parts shown in package content. Check and make sure they are included and in good condition. If anything is missing, or damaged, contact the supplier immediately.

How To Clean Your LCD Monitor



Caution :

- To avoid the risk of electric shock, make sure your hands are dry before unplugging your monitor from or plugging your monitor into an electrical outlet.
- When you clean your monitor, do not press down on the LCD screen. Pressing down on the screen can scratch or damage your display. Pressure damage is not covered under warranty.
- Use only cleansers made specifically for cleaning monitors and monitor screens. Cleansers not made to clean monitors and monitor screens can scratch the LCD display or strip off the finish.
- Do not spray any kind of liquid directly onto the screen or case of your monitor. Spraying liquids directly onto the screen or case can cause damage which is not covered under warranty.
- Do not use paper towels or abrasive pads to clean your monitor. Using an abrasive pad or any wood based paper product such as paper towels can scratch your LCD screen.

Cleaning Your Monitor

To clean your LCD safely, please follow these steps :

- ① Disconnect the power cord.
- ② Gently wipe the surface using a clean, dry microfiber cloth. Use as little pressure as possible.

Cleaning Tough Marks and Smudges

To remove tough marks and smudges, please follow these steps :

- ① Disconnect the power cord.
- ② Spray a small amount of non-abrasive cleanser on a microfiber cloth.



Caution : Do not spray or apply any liquids directly onto the monitor. Always apply the solution to your microfiber cloth first, not directly on the parts you are cleaning.

- ③ Gently wipe the surface. Use as little pressure as possible.
- ④ Wait until your monitor is completely dry before plugging it in and powering it up.

**AP-19 / NAP-19
HAP-19 / HNAP-19**



- 19" LCD display X 1**
- 6ft VGA cable X 1**
- Power adapter X 1**
- Power cord X 1**

Mounting hardware X 1 pack

- Mounting bracket x 4 pcs
- M4* 6mm screw x 8 pcs
- M4* 50mm screw x 8 pcs

Basic I/O

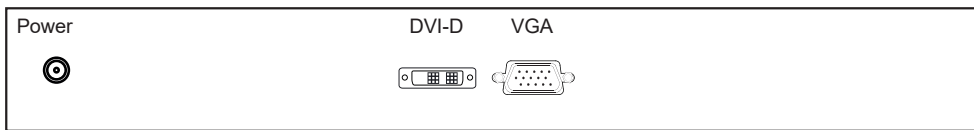

AV2.2D upgrade I/O

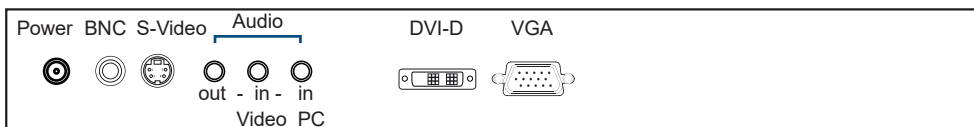

AV2.2H upgrade I/O

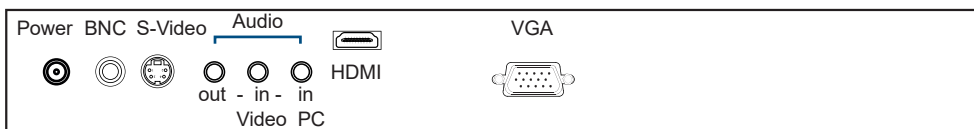

AV3.0 upgrade I/O with advanced features

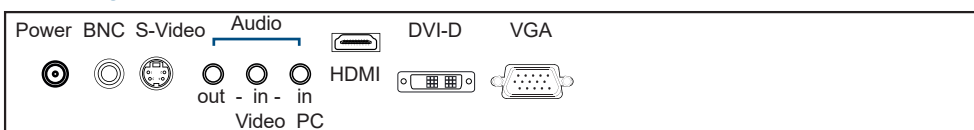

- An abundance of input connections that include HDMI, DVI-D, VGA, S-Video + BNC and audio
- On-chip Faroudja® DCDi Cinema processing
- Casing dimensions will be changed

< 1.2 > Structure Diagram

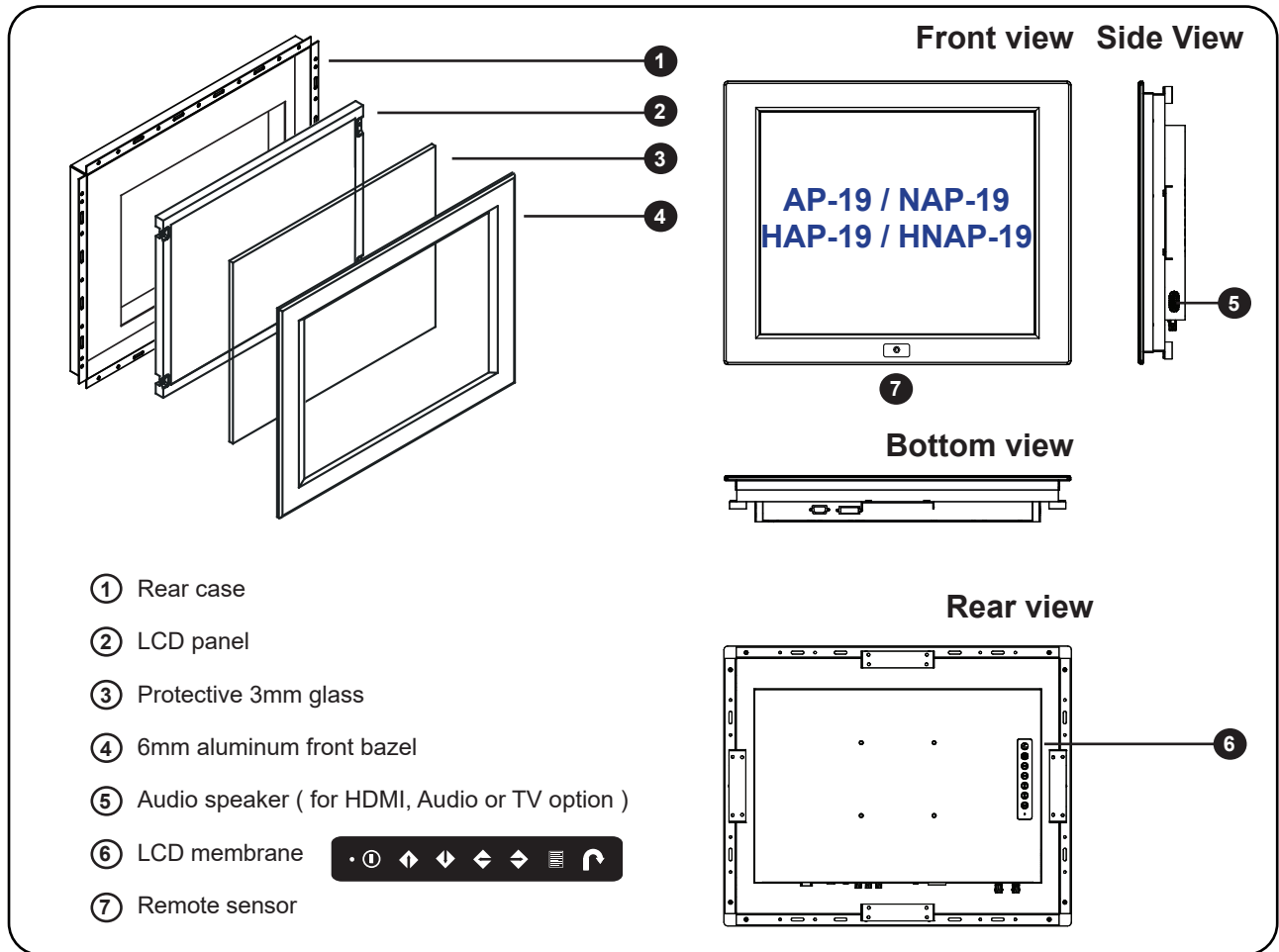

Model	Product Dimension (W x D x H)	Packing Dimension (W x D x H)	Net Weight	Gross Weight
AP-19 NAP-19 HAP-19 HNAP-19	476.5 x 63.6 x 384.1 mm 18.8 x 2.5 x 15.1 inch	651 x 124 x 597 mm 25.6 x 4.9 x 23.5 inch	7.7 kg 16.9 lb	10.5 kg 23.1 lb

< 1.2 > Dimension

19" LCD Display

Front View

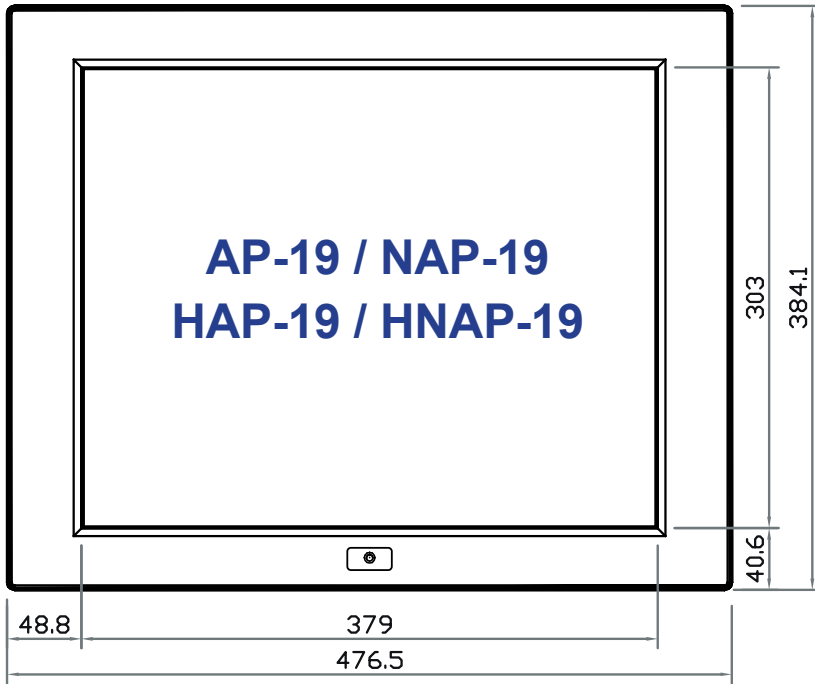

Side View

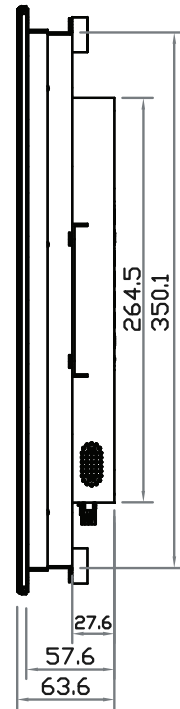

Rear View

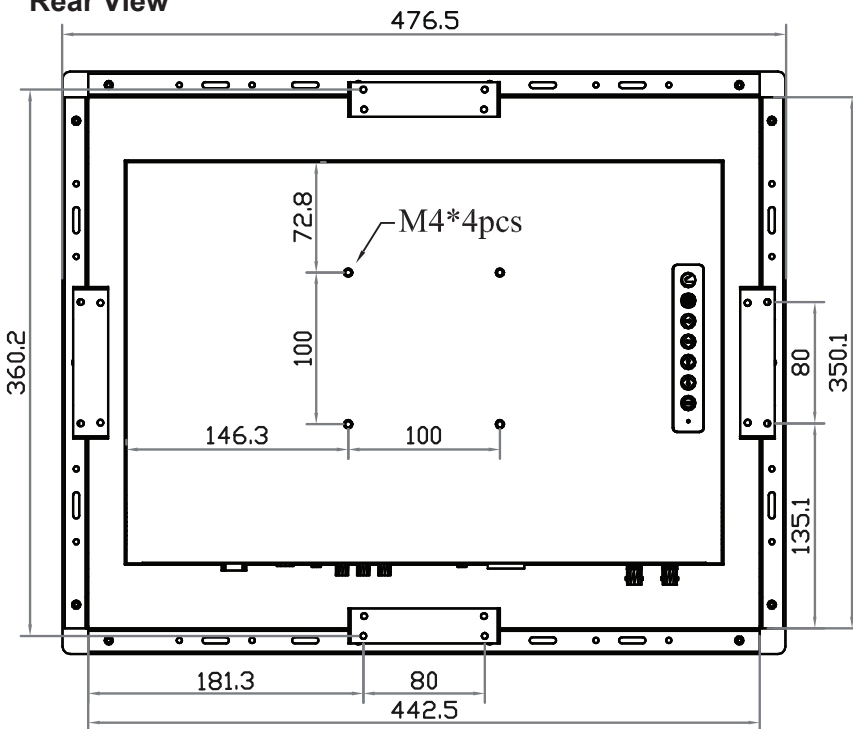

UNIT : mm
1mm = 0.03937 inch

Bottom View

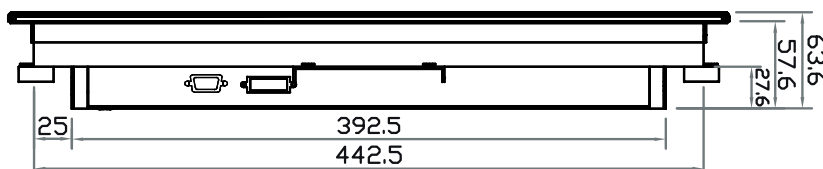

< 1.3 > Installation (I) Panel mount

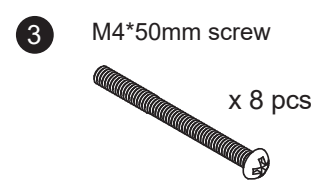
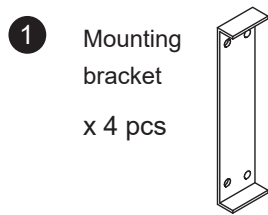

Hardware set part no. UV-BK#2

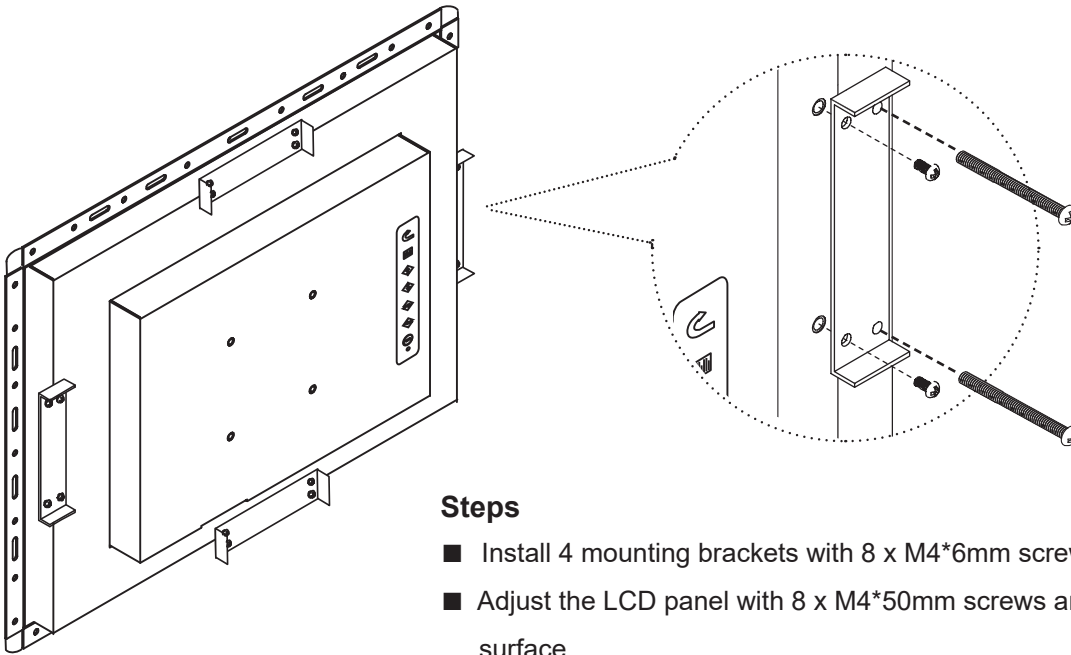

Steps

- Install 4 mounting brackets with 8 x M4*6mm screws
- Adjust the LCD panel with 8 x M4*50mm screws and fix it on the surface.

(II) VESA mount (100*100mm)

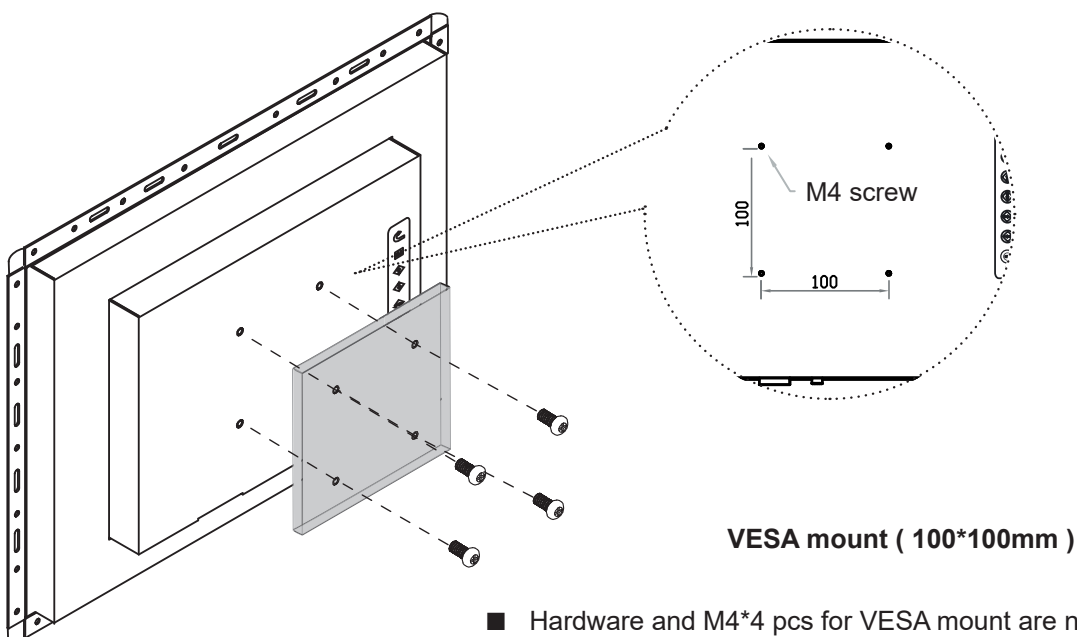

DP-19 / HDP-19



17" FHD LCD display X 1

6ft VGA cable X 1

Power adapter X 1

Power cord X 1

Mounting hardware X 1 pack

- Mounting bracket x 4 pcs

- M4* 6mm screw x 8 pcs

- M4* 50mm screw x 8 pcs

Basic I/O

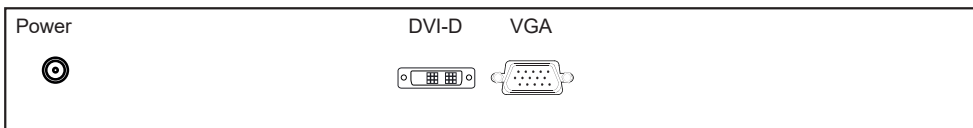

AV2.2D upgrade I/O

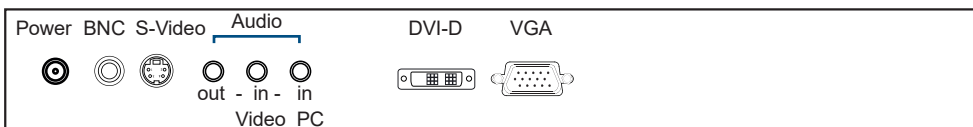

AV2.2H upgrade I/O

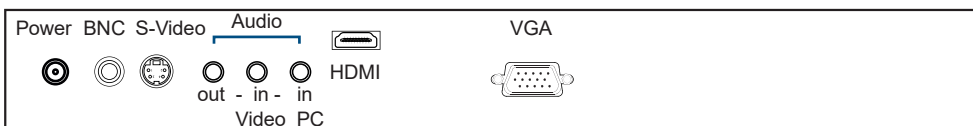

AV3.0 upgrade I/O with advanced features

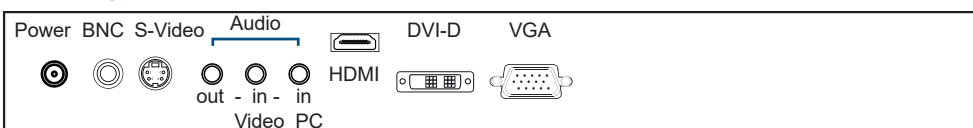

- An abundance of input connections that include HDMI, DVI-D, VGA, S-Video + BNC and audio
- On-chip Faroudja® DCDi Cinema processing
- Casing dimensions will be changed

< 2.2 > Structure Diagram

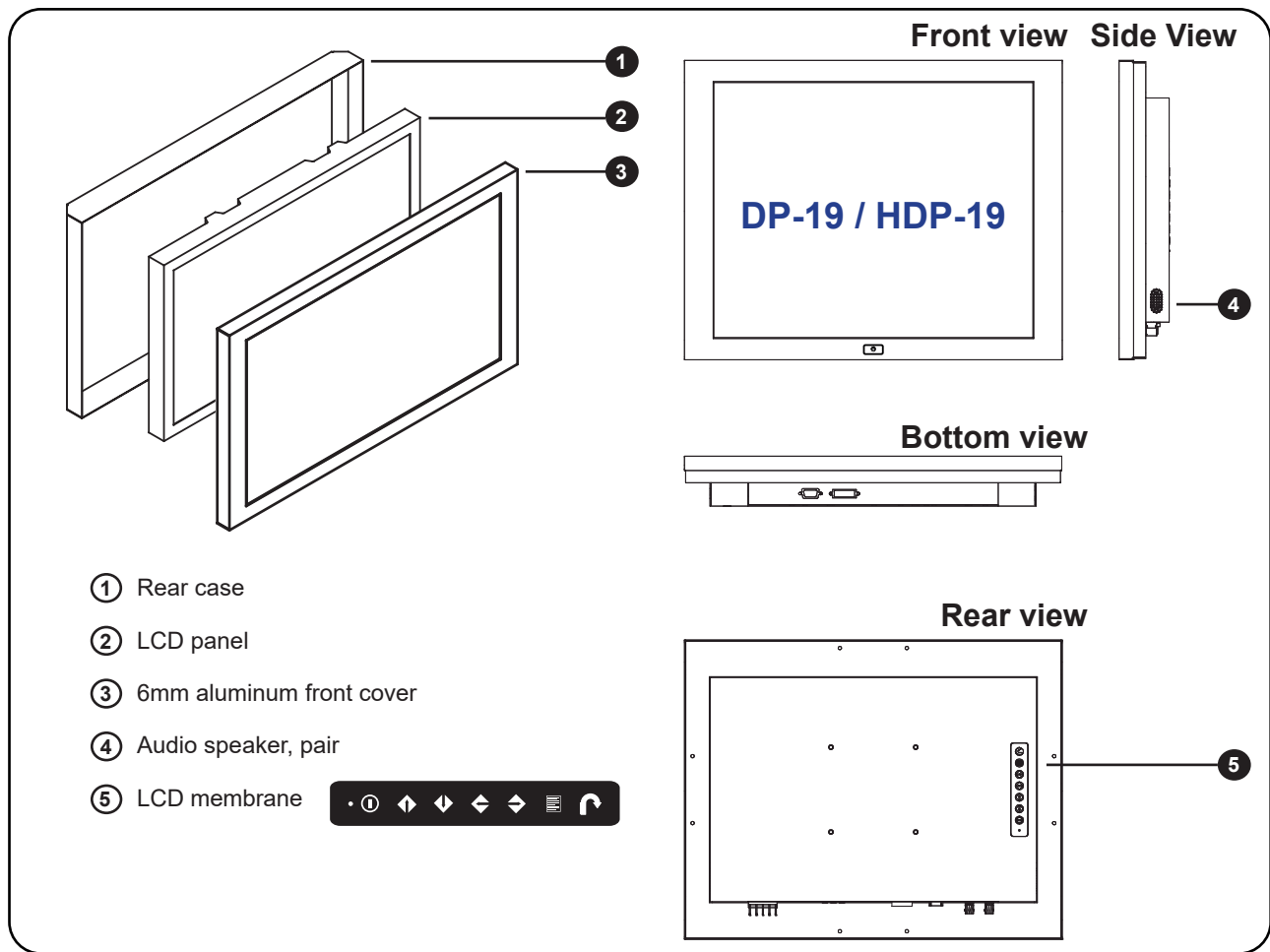

Model	Product Dimension (W x D x H)	Packing Dimension (W x D x H)	Net Weight	Gross Weight
DP-19 HDP-19	445.5 x 58.9 x 353.1 mm 17.5 x 2.3 x 13.9 inch	651 x 124 x 597 mm 25.6 x 4.9 x 23.5 inch	6.7 kg 14.7 lb	9.5 kg 20.9 lb

< 2.2 > Dimension

19" LCD Display

Front View

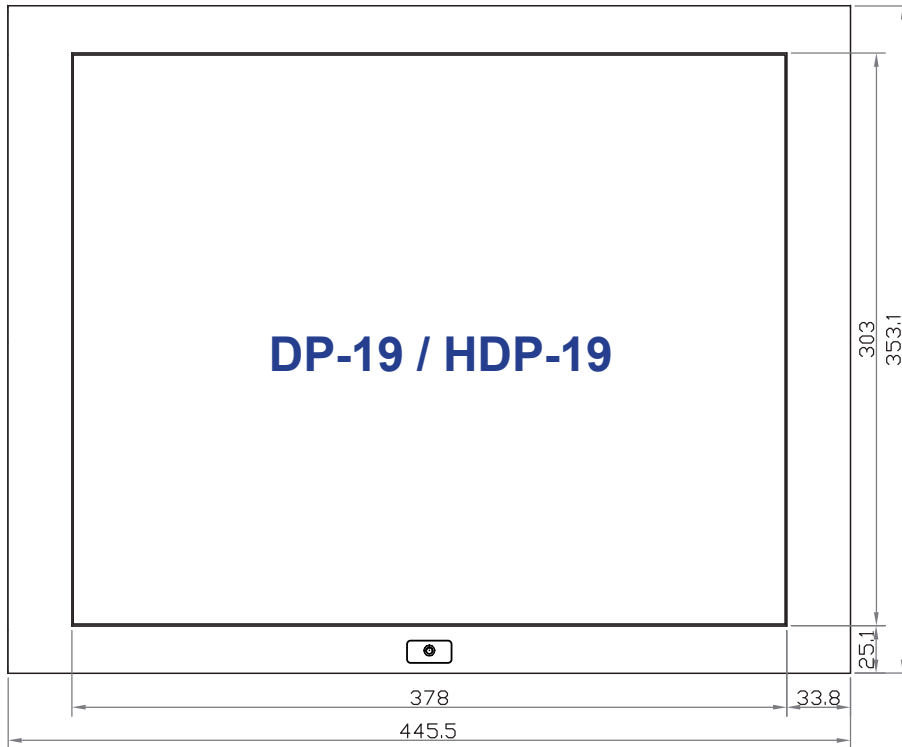

Side View

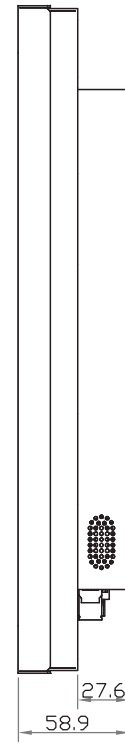

Rear View

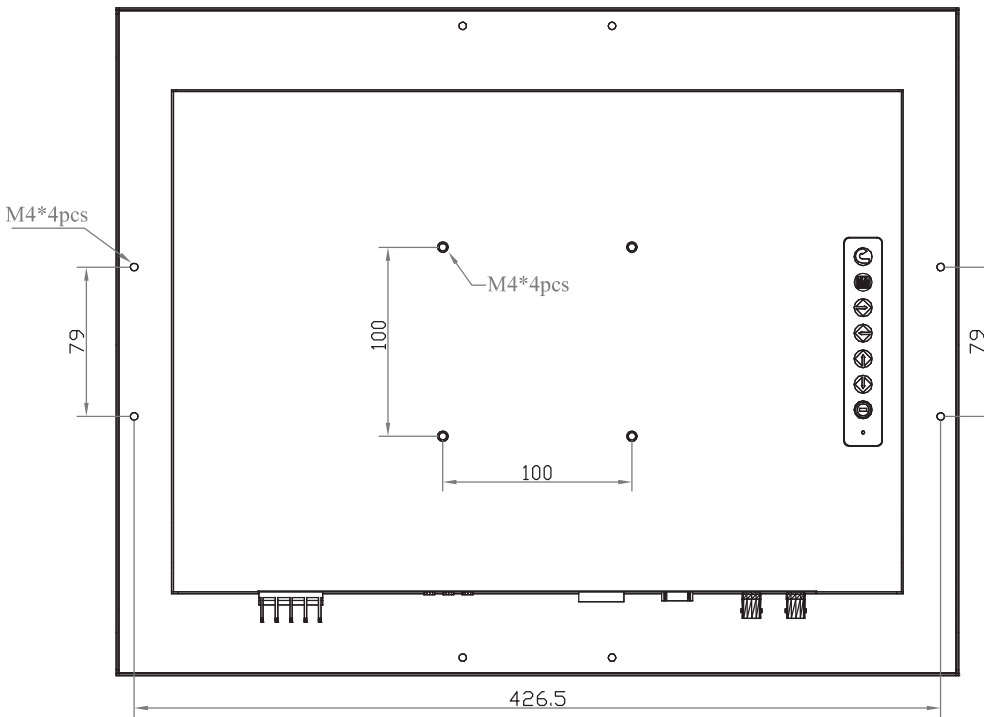

UNIT : mm
1mm = 0.03937 inch

Bottom View

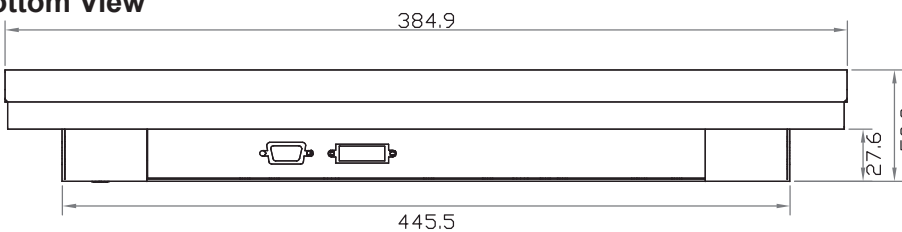

< 2.3 > VESA mount Installation

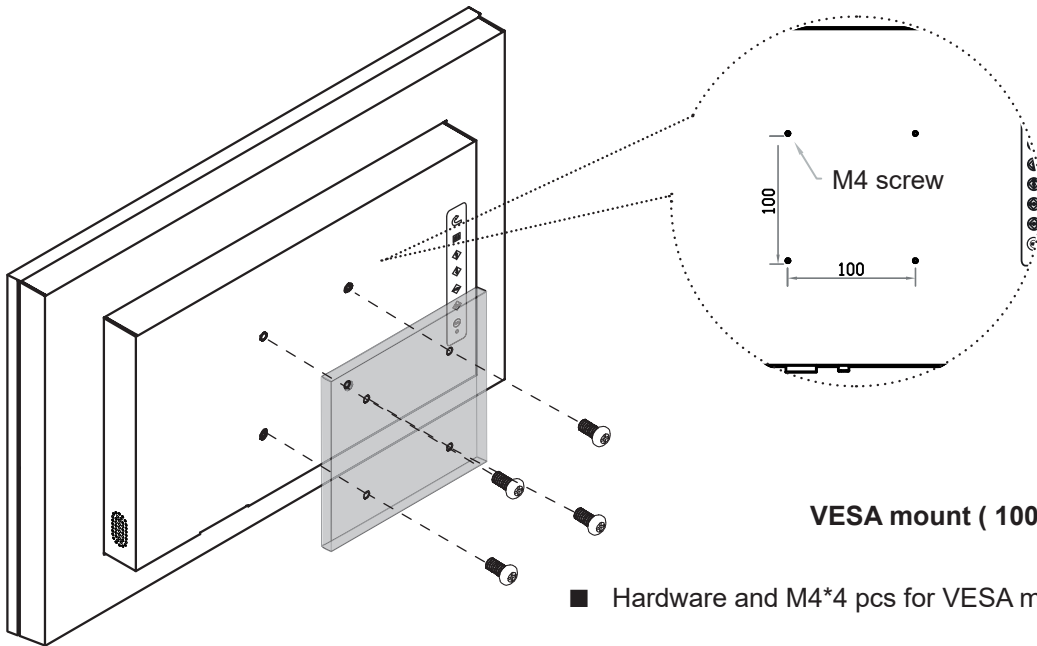

OP-19 / HOP-19



- 19" LCD display X 1
- 6ft VGA cable X 1
- Power adapter X 1
- Power cord X 1

Basic I/O

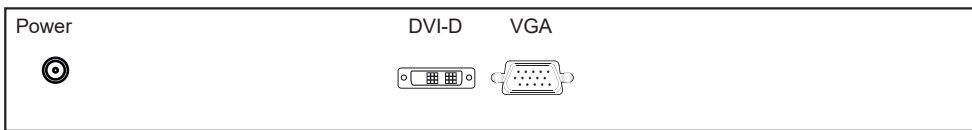

AV2.2D upgrade I/O

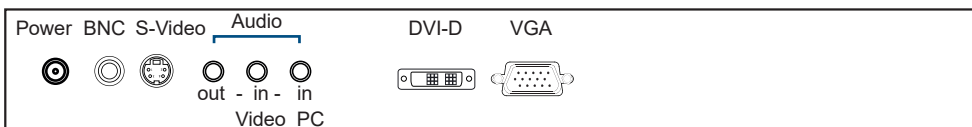

AV2.2H upgrade I/O

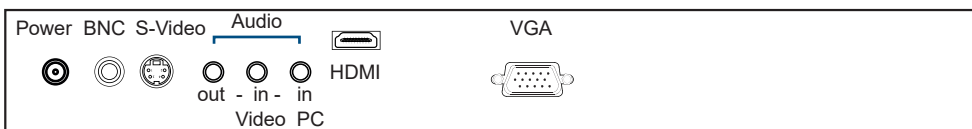

AV3.0 upgrade I/O with advanced features

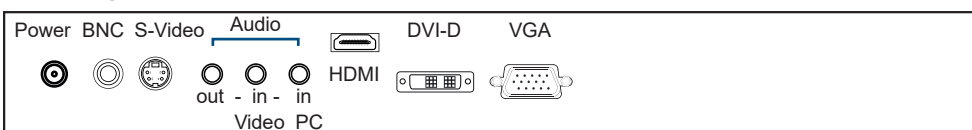

- An abundance of input connections that include HDMI, DVI-D, VGA, S-Video + BNC and audio
- On-chip Faroudja® DCDi Cinema processing
- Casing dimensions will be changed

< 3.2 > Structure Diagram

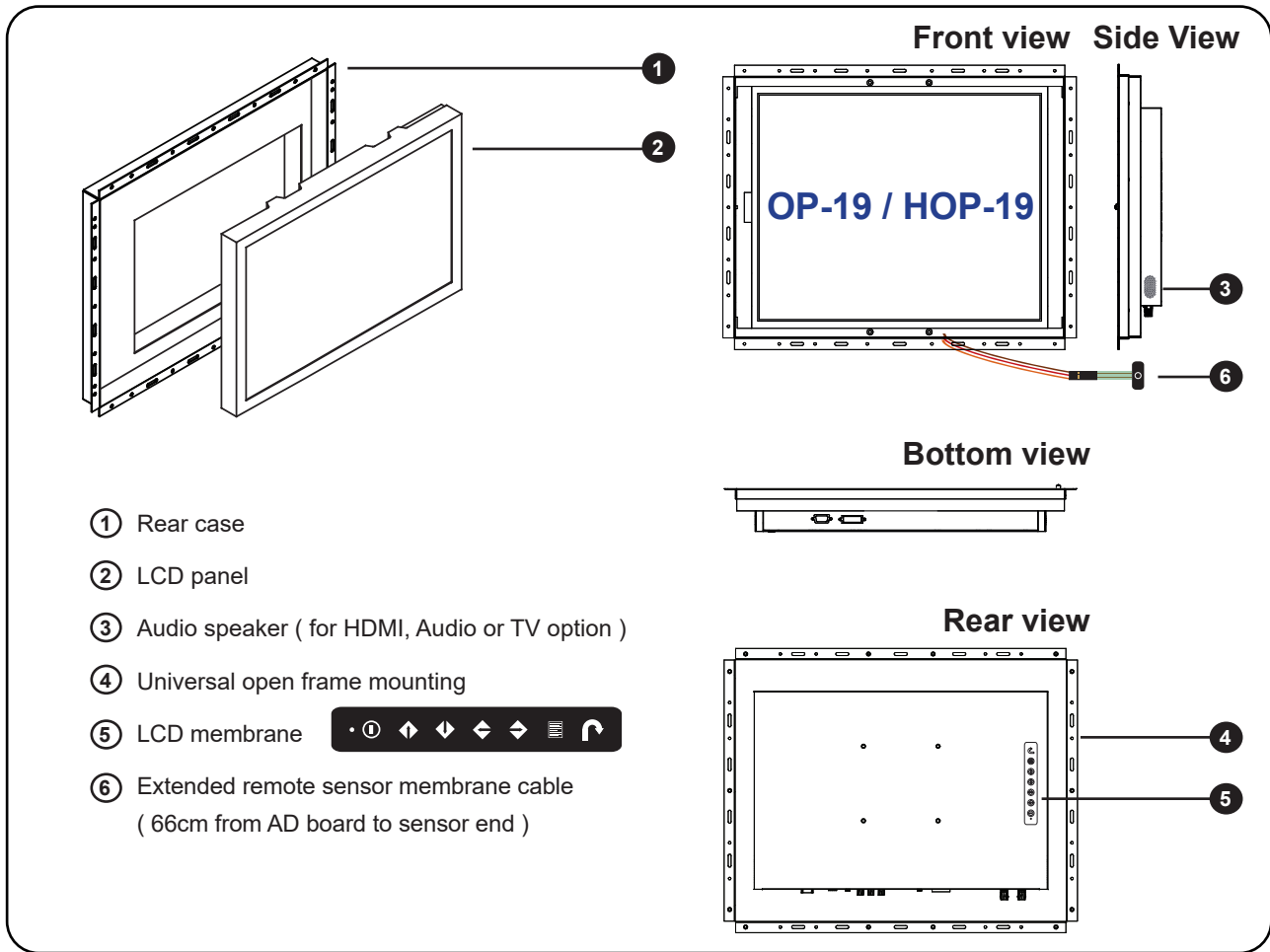

Model	Product Dimension (W x D x H)	Packing Dimension (W x D x H)	Net Weight	Gross Weight
OP-19 HOP-19	473.5 x 57.6 x 381.1 mm 18.6 x 2.3 x 15 inch	651 x 124 x 597 mm 25.6 x 4.9 x 23.5 inch	5.7 kg 12.5 lb	8.5 kg 18.7 lb

< 3.2 > Dimension

19" LCD Display

Front View

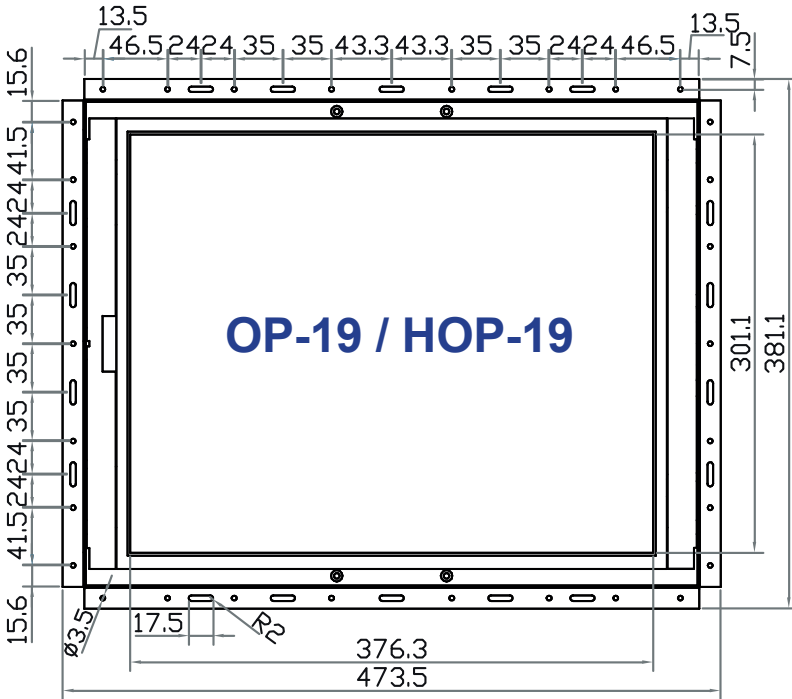

Side View

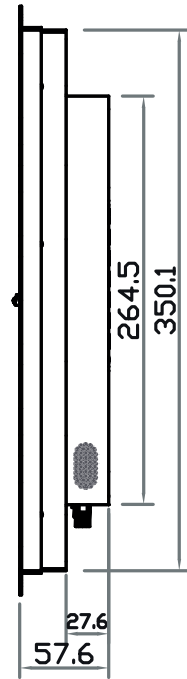

Rear View

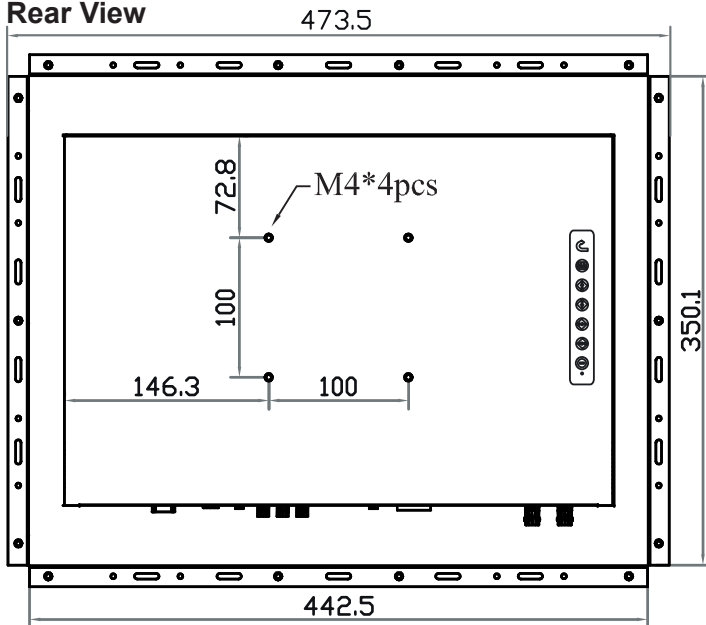

UNIT : mm
1mm = 0.03937 inch

Bottom View

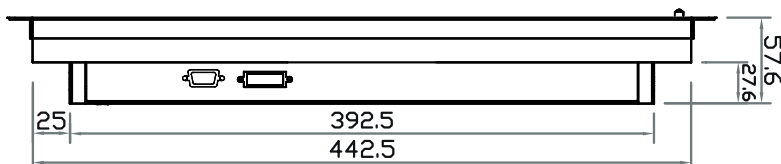

< 3.3 > Installation

(I) Universal mount

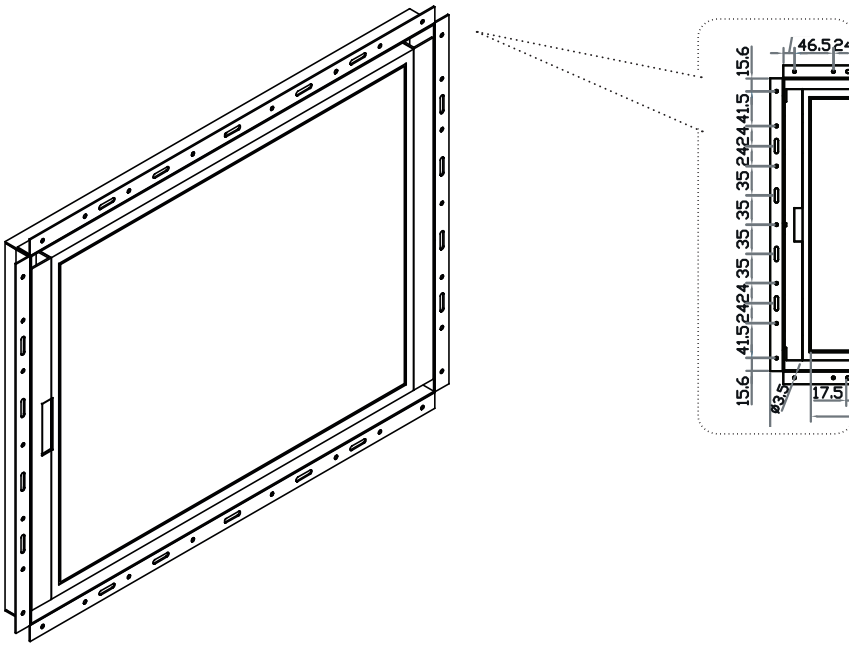

(II) VESA mount (100*100mm)

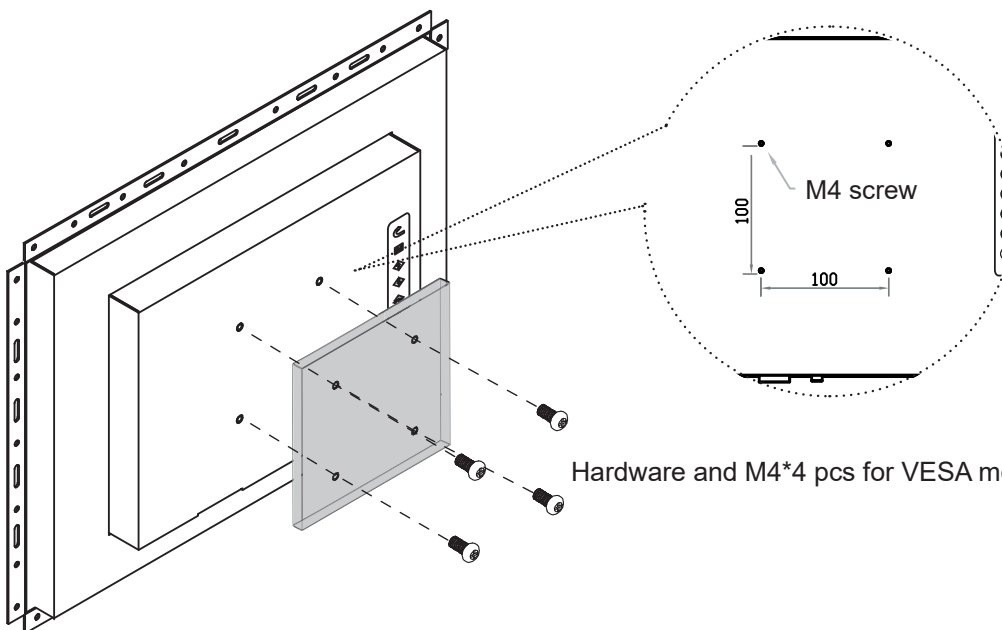

Hardware and M4*4 pcs for VESA mounting are not provided

< Part 4 >

< 4.1 > Product Specifications

19" LCD Display

Mechanical Design	AP-19 / HAP-19	NAP-19 / HNAP-19	DP-19 / HDP-19	OP-19 / HOP-19
Protection	6mm front bezel	NEMA 4 / IP65	front cover	open frame
Front panel	Black, RAL 9005			-
Rear casing	Black, RAL 9005			
VESA mount	100 x 100 mm			
Universal mount	-	-	-	ready
Desktop stand	option	-	option	-
Panel mount	bundled	-	-	-

LCD Panel	Standard	Sunlight Readable
Brightness (cd/m ²)	250	1000 ^{***}
Panel size (diagonal)	19-inch TFT color LCD	
Native resolution	1280 x 1024	
Contrast ratio (typ.)	1000 : 1	
Colors	16.7 M	
Viewing angle (L/R/U/D)	85/85/80/80	
Response time (ms)	5	
Dot pitch (mm)	0.294	
Display area (mm)	376.32H x 301.06V	
Surface treatment	Haze 25%, Hard-coating	
Surface hardness	3H	
Backlight type	LED	
MTBF (hrs)	30,000	

Video	
VGA	Analog 0.7Vp-p
DVI	DVI-D single link
Option HDMI	HDMI 1.2 / HDCP 1.1
Composite (BNC)	NTSC & PAL
S-video (4 pin)	NTSC & PAL

Audio Option	
Input Connector	3.5mm stereo jack
Impedance / Power level	30kΩ / 750mV
Output Connector	3.5mm stereo jack
Resistance / Power level	30kΩ / 2.8V
Speaker:	
Dual Stereo	2W x 2

*When the audio output is connected, speaker output is OFF

Power	Standard	Sunlight Readable
Input	Auto-sensing 100 to 240VAC, 50 / 60Hz	
Consumption:		
Screen ON	Max. 22W	Max. 39W
Power saving mode	Max. 2W	Max. 2W
Power button OFF	Max. 1W	Max. 1W

Compliance	
EMC	FCC & CE certified
Safety	CE / LVD certified
Environment	RoHS3 & REACH compliant

< 4.1 > Product Specifications

Environmental Conditions		
Operating	Temperature	0 to 55°C degree
	Humidity	20~90%, non-condensing
	Altitude	16,000 ft
Storage / Non-operating	Temperature	-20 to 60°C degree
	Humidity	5~90%, non-condensing
	Altitude	40,000 ft
	Shock	10G acceleration (11ms duration)
	Vibration	10~300Hz 0.5G RMS random vibration

Physical Specification	AP-19 / HAP-19	NAP-19 / HNAP-19	DP-19 / HDP-19	OP-19 / HOP-19
Product (W x D x H)				
mm	476.5 x 63.6 x 384.1		445.5 x 58.9 x 353.1	473.5 x 57.6 x 381.1
inch	18.8 x 2.5 x 15.1		17.5 x 2.3 x 13.9	18.6 x 2.3 x 15
Packing (W x D x H)				
mm	651 x 124 x 597		651 x 124 x 597	651 x 124 x 597
inch	25.6 x 4.9 x 23.5		25.6 x 4.9 x 23.5	25.6 x 4.9 x 23.5
Net Weight	7.7 kg / 16.9 lb	7.7 kg / 16.9 lb	6.7 kg / 14.7 lb	5.7 kg / 12.5 lb
Gross Weight	10.5 kg / 23.1 lb	10.5 kg / 23.1 lb	9.5 kg / 20.9lb	8.5 kg / 18.7 lb
Chassis color	Dark			
Chassis materials	Aluminum			

* All dimensions stated are subject to change if options are selected / integrated to base model part codes

Applicable Format		
DVI-D / VGA Input	PC Signal	1280 x 1024 x 60 / 75Hz
		1280 x 960 x 60Hz
		1280 x 768 x 60 / 75Hz
		1152 x 864 x 75Hz
		1024 x 768 x 60 / 70 / 75Hz
		848 x 480 x 60Hz
		800 x 600 x 60 / 72 / 75Hz
		720 x 400 x 70Hz
		640 x 480 x 60 / 72 / 75Hz
		640 x 400 x 70Hz
HDMI Input	PC Signal	1280 x 1024 x 60 / 75Hz
		1280 x 960 x 60Hz
	HDMI 1.2	1280 x 720 x 50 / 60Hz (720p)
		720 x 480 x 50 / 60Hz (576p / 480p)
Audio Signal	2ch Linear PCM	

* In some circumstances, if the user connects the LCD to PC via HDMI port for video and audio signals, the LCD may display incorrectly on a full screen. If so, please adjust the display card setting on display size to fix the issue.

- Power light
- Green = On
- Orange = Power saving

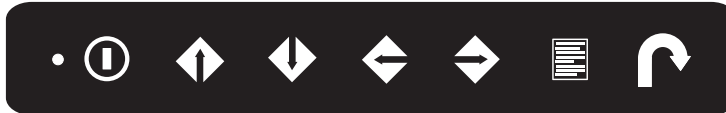

Membrane Switch	Function
	Power on / off LCD
	Display the OSD menu
	Scrolls through menu options and adjusts the displayed control (To auto adjustment by pressing the button for 5 seconds)
	Exit the OSD screen Toggle analog, digital & video connection (DVI-D and video options only)

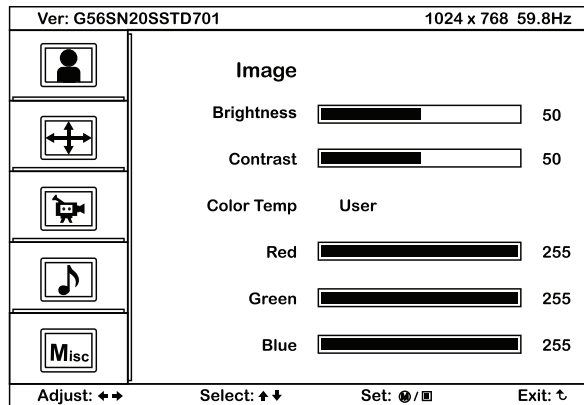

OSD Configuration Page



Image:
for the brightness, contrast, color temp, red, green, and blue

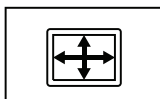

Geometry:
for the auto adjust, H position, V position, phase and clock



Video:
for the colour, tint, sharpness, noise reduction, DCDi and TV Setup



Audio:
for volume, bass, treble, balance, AVL and mute



Misc:
for the language, OSD position, graphic mode, ratio, reset and timer

< Part 5 > Option

< 5.1 > Option Table

Options	AP / NAP	HAP / HNAP	DP	HDP	OP	HOP
SDI ***	✓	✓	✓	✓	✓	✓
HDMI *	✓	✓	✓	✓	✓	✓
S-Video * + Composite (BNC)	✓	✓	✓	✓	✓	✓
Audio	✓	✓	✓	✓	✓	✓
Touchscreen	✓	✓	✓	✓	✓	✓
MCS multi-display control	✓	✓	✓	✓	✓	✓
DC Power	✓	✓	✓	✓	✓	✓
MIL-type / lockable connector	✓	✓	✓	✓	✓	✓
TV (Analog) *	✓	✓	✓	✓	✓	✓
Auto / switch dimming		✓		✓		✓

*** About SDI

- (1) The AD board will be upgraded to version 3.0, and this comes standard with HDMI, DVI-D, VGA, S-Video, BNC, audio inputs and RC-2 remote controller.



* About HDMI and DVI-D

- (1) For AV2.2 upgrade, either HDMI or DVI-D is provided.
- (2) If the user needs HDMI and DVI-D, AV3.0 upgrade can be applied.
- (3) In some circumstances, if the user connects the LCD to PC via HDMI port for video and audio signals, the LCD may display incorrectly on a full screen. If so, please adjust the display card setting on display size to fix the issue.

* Remote Controller

- (1) AV2.2 upgrade comes with RC-2 remote controller.
- (2) TV option comes with RC-2 remote controller.

< 5.2 > Options : 3G / HD / SD-SDI input

19" LCD Display

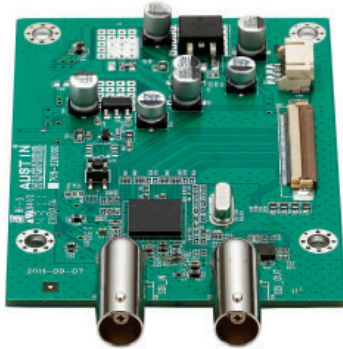

Austin Hughes' SDI input is an ideal solution for the broadcast-grade video and high resolution CCTV market.

Designed for use with UltraView displays, a SDI input module can support up to 1080p @60Hz resolution without using additional space or power and it comes standard with a 2-year warranty.

SDI

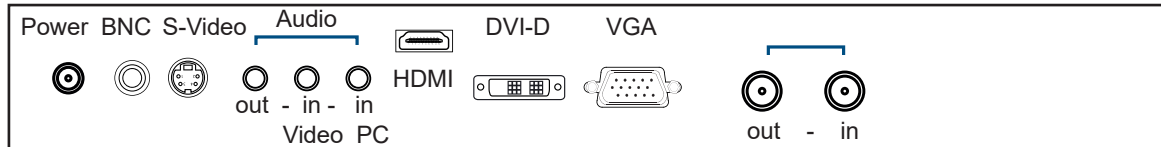

*** For **SDI** option, the AD board will be upgraded to AV3.0, and this comes standard with HDMI, DVI-D, VGA, S-Video, BNC, audio inputs and RC-2 remote controller (please refer to P.25). Casing dimensions will be changed.

INPUT	3G-SDI IN	BNC x 1 / 0.8Vp-p (75 ohm)
	3G-SDI OUT	BNC x 1 / Active through, equalized & relocked

Standard Compliance	Video	SMPTE 425M / 274M / 296M / 125M ITU-R BT.656
	Audio	SMPTE 299M / 272M-C

Compatible Video Format	3G-SDI	1080p @60 / 50Hz, 4:2:2
		1080p @30 / 25 / 24Hz, 4:4:4
		1080i @60 / 50Hz, 4:4:4
		720p @60 / 50Hz, 4:4:4
		HD-SDI
		1080i @60 / 50Hz, 4:2:2
		720p @60 / 50Hz, 4:2:2
	SD-SDI	480i @60Hz, 4:2:2
	ITU-R BT.656	576i @50Hz, 4:2:2

Compatible Audio Format	3G-SDI	48kHz, 16 / 20 / 24 bit, 2 CH, Synchronized Video
	HD-SDI	48kHz, 16 / 20 / 24 bit, 2 CH, Synchronized Video
	SD-SDI	48kHz, 16 / 20 / 24 bit, 2 CH, Synchronized / Asynchronous Video

Max. Transmission Distance 75 ohm coaxial cable	3G-SDI	150m at 2.97Gb/s
	HD-SDI	250m at 1.485Gb/s
	SD-SDI	480m at 270Mb/s

< 5.3 > Options : MCS

MCS (Multi-display Control)

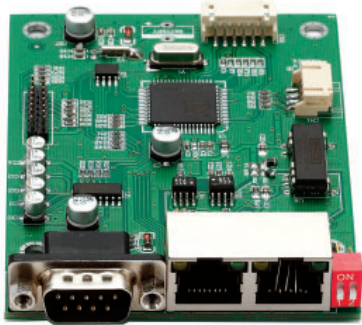

More control is always good. Especially when it is necessary and easy. Austin Hughes provides MCS solution to control the **OSD** of various UltraView LCD display up to 64 units.

The RS-232C is used for the communication between the PC and the first display via a 15 feet serial cable while the CAN bus is used for the various LCD displays cascade together via CAT 5/6 cable, and daisy chain up to 1,000 meters.

Designed for use with UltraView LCD displays, Austin Hughes provides a MCS input module without using additional space or power and it comes standard with a 2-year warranty.

MCS

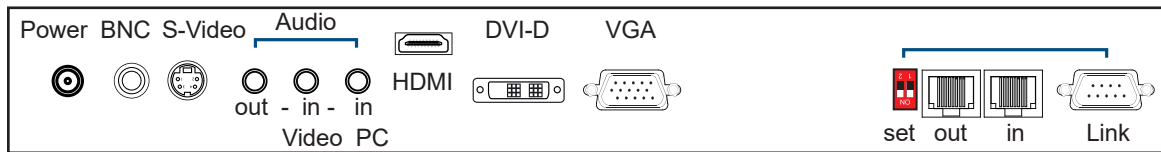

*** Please download the protocol of MCS control at :
<http://www.austin-hughes.com/support/usermanual/ultraview/UM-UV-MCS.pdf>

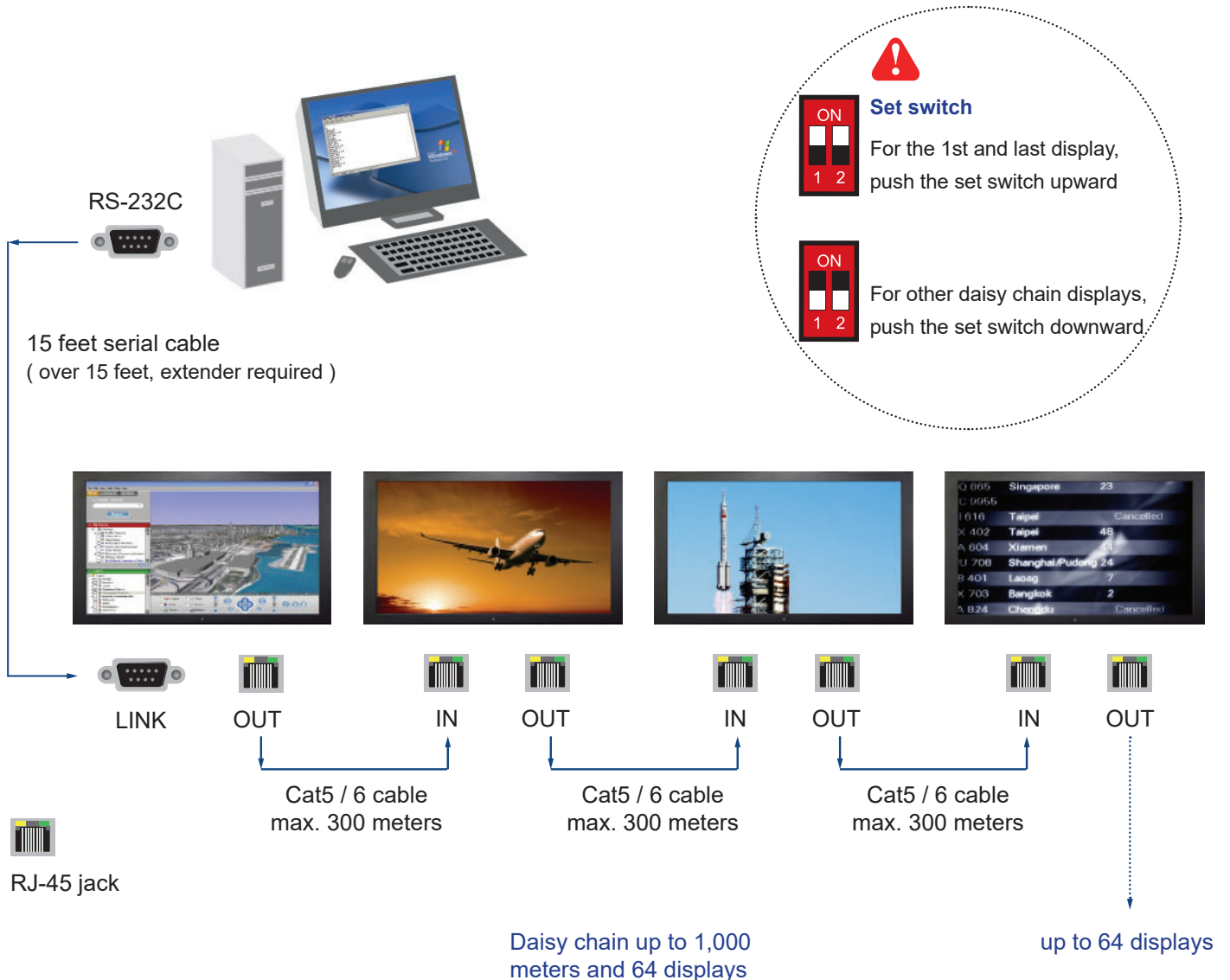

AV2.2D Upgrade Options

- **DVI-D** (DVI-D TMDS single link)
- **AV** (S-Video + Composite, BNC)
- **Audio** (Built-in Dual Stereo Speakers, 2W x 2)
(3.5mm audio jacks for audio in & out)

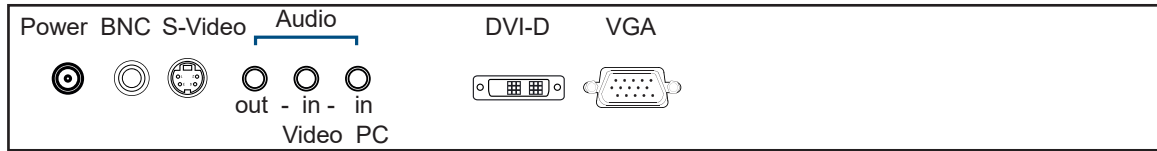

AV2.2H Upgrade Options

- **HDMI** (HDMI 1.2, CEA-861-D)
- **AV** (S-Video + Composite, BNC)
- **Audio** (Built-in Dual Stereo Speakers, 2W x 2)
(3.5mm audio jacks for audio in & out)

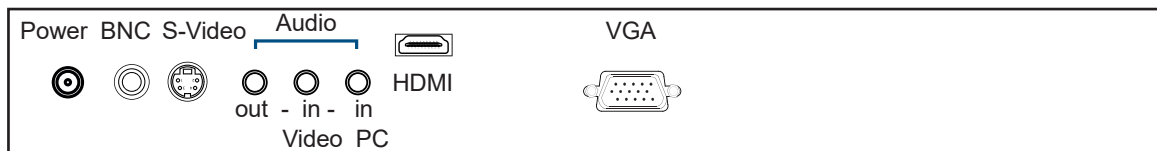

- (1) In some circumstances, if the user connects the LCD to PC via HDMI port for video and audio signals, the LCD may display incorrectly on a full screen. If so, please adjust the display card setting on display size to fix the issue.
- (2) AV2.2 upgrade option comes with RC-2 remote controller x 1 (please refer to P.25)

< 5.4 > AV3.0 Upgrade Options :

- **HDMI** (HDMI 1.2, CEA-861-D)
- **DVI-D** (DVI-D TMDS single link)
- **AV** (S-Video + Composite, BNC)
- **Audio** (Built-in Dual Stereo Speakers, 2W x 2)
(3.5mm audio jacks for audio in & out)

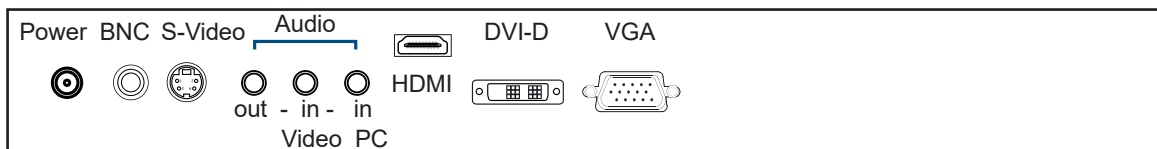

- (1) In some circumstances, if the user connects the LCD to PC via HDMI port for video and audio signals, the LCD may display incorrectly on a full screen. If so, please adjust the display card setting on display size to fix the issue.
- (2) Casing dimensions will be changed.

< 5.6 > Options : Touchscreen & driver



19" USB Touchscreen Specification

Model	TPC-10 Multi-touch	TRB e-Resistive	TCB e-Capacitive
Technology	Projected Capacitive	5-Wire Resistive	Capacitive
Touch Point	10	Single	Single
Input Type	Finger or Capacitive Stylus	Finger or Stylus	Finger
Resolution	2048 x 2048	2048 x 2048	2048 x 2048
Touch Point Accuracy	± 10 mm offset	-	-
Response Speed	Max. 20 ms	15 ms	20 ms
Activation Force	≤ 10 g	≤ 50 g	≤ 50 g
Surface Hardness	7H	3H	9H
Light Transmission	≥ 88%	80% ± 3%	92% ± 2%
Haze	≤ 2%	8% ± 3%	7%
Durability	> 100 million touches	10 million touches	300 million touches
Top Layer	1.8 mm Tempered Glass	ITO Film	Glass
Bottom Layer	Film	ITO Glass	
Thickness	2.2 mm	3.2 ± 0.2 mm	2.8 mm ± 10%
Connector	USB Type A	USB Type A	USB Type A
Compatibility	Windows 7	Windows 7 / XP / Vista, Linux	

- Dimension will be changed if Multi-touch required
- USB touchscreen package includes 1 x 6ft USB cable, quick reference guideline and CD disc
- For detailed information, please refer to the attached CD disc
- As the touchscreen unit is not made of toughened glass, please handle it carefully

USB Touchscreen

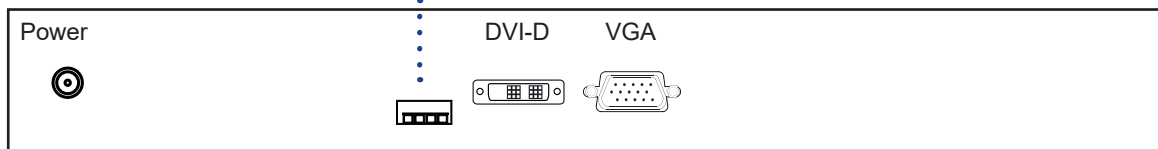



TPC-10 Driver



Connect the USB cable from the USB port on the LCD to a computer. The touch screen supports easy Plug-and-Play operations. There is no need to install additional drivers on the computer.

TRB / TCB Driver

Please follow the below steps to setup the touch screen:-

Step 1. Run the bundled CD disc or download the driver from the link below :

<http://www.austin-hughes.com/resources/driver/ultraview>

Step 2. Double click the Setup.exe

Step 3. Follow the installation instruction to finish the setup

Step 4. After installation, run the TouchKit program & the "4 point calibration"



Please do the initial calibration after the first setup

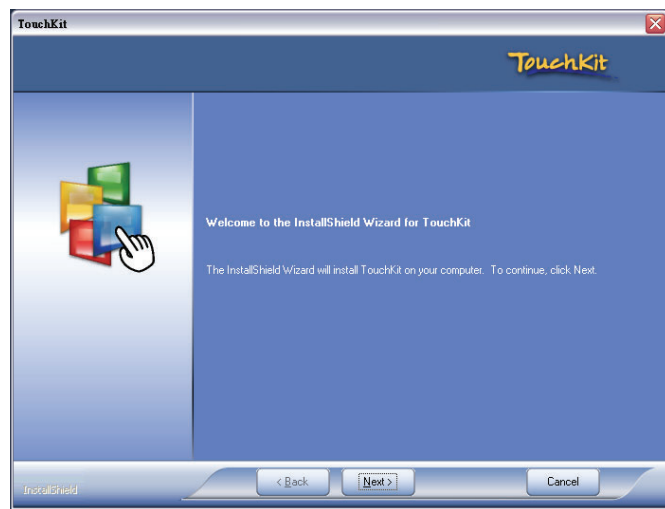

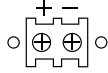

< 5.7 > Options : DC Power





Model	12V	24V	48V	125V
Input rating				
Input voltage:	12-Volt	24-Volt	48-Volt	110-Volt
Input range:	9 ~ 18V	18 ~ 36V	36 ~ 75V	66 ~ 160V
Input current				
- No load	50 mA	50 mA	50 mA	35 mA
- Full load	4950 mA	2450 mA	1220 mA	749 mA
Output rating				
Output voltage:	12-Volt	12-Volt	12-Volt	12-Volt
Output current:	4.16A	4.16A	4.16A	6.25A
Efficiency	84%	85%	85%	91%

*** For DC power option :

(1) If the unit with LCD, **earthing** may be required 

	Input	Part no.	MIL Standard
MIL - type Connector	DC Power *** (Male)	MS3470W8-33P 	MIL - DTL - 26482
	VGA *** (Male)	MS3470W14-15P 	MIL - DTL - 26482

*** There are several additional MIL DC and VGA connector types with varying design characteristics to meet cost considerations and to provide users with the most design flexibility possible. For more information, please contact us.

	Input	Part no.	Standard
Lockable Connector	DC Power (Male)	YM-Ext-461CP001 	D-type 3W3
	USB	LUSB - A111 - 00 	-

*** MIL - type or Lockable connectors above can be integrated with our LCD displays. Sale service just for connectors not provided.

< 5.9 > Options : TV (Analog)

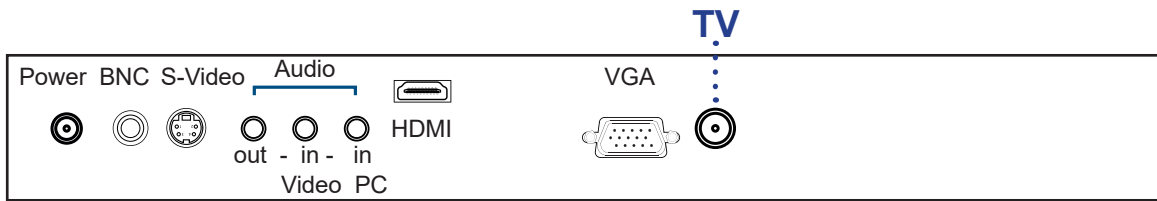

*** For TV option :

- (1) The AD board comes standard with HDMI, VGA, S-Video, BNC, audio inputs and RC-2 remote controller.
- (2) Casing dimensions will be changed.

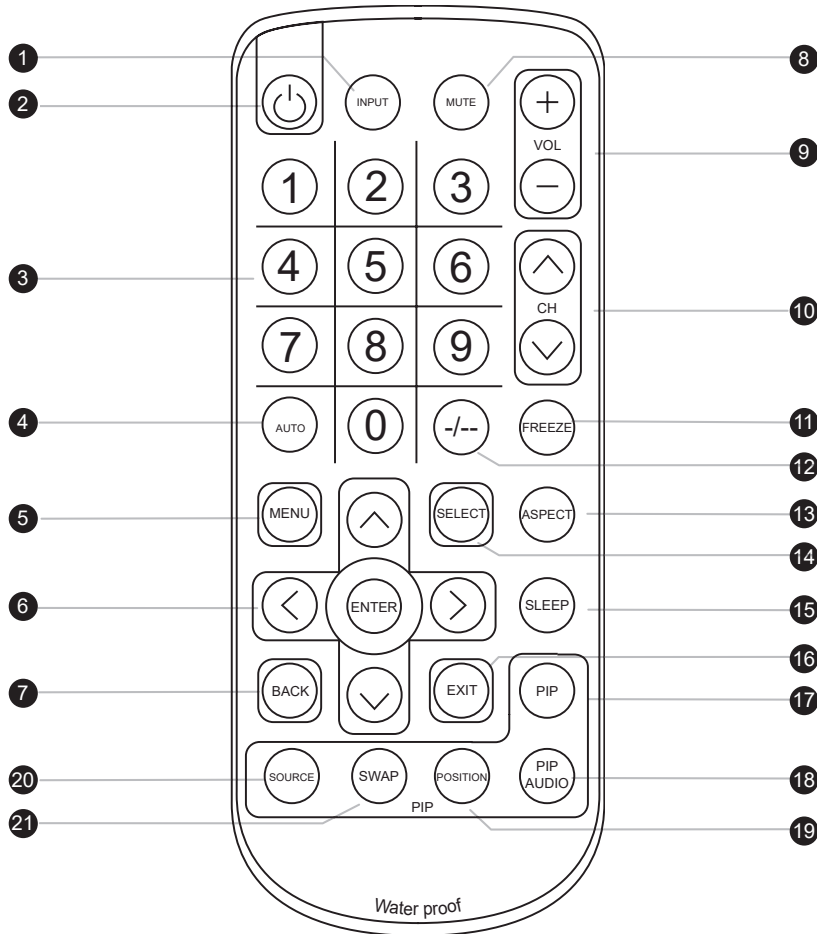

①	INPUT	Select the source
②		Switches on or off the TV
③	0 - 9	Only use in TV mode. Select channels. For channel numbers 10 and above, enter the second digit within two seconds.
④	AUTO	Auto adjust
⑤	MENU	Display the menu on the screen or go to the previous menu
⑥	▲ / ▼ / ◀ / ▶ / ENTER	Go to the upper menu or select the previous value / Go to the next menu or select the next value / Decrease the setting value / Increase the setting value or enter to the select item setting Enter to the select item settings or exclude the setting
⑦	BACK	Back to previous value
⑧	MUTE	Turn on or off the speaker
⑨	Vol + / -	Increase or decrease the speaker volume
⑩	CH + / -	For TV model only, increase or decrease the channel number
⑪	FREEZE	Reserve for OEM model
⑫	- / - -	For setting input single or double digits
⑬	ASPECT	Adjust the screen size
⑭	SELECT	To select the existing item
⑮	SLEEP	Select the sleeping time
⑯	EXIT	Exit the menu or cancel
PIP functions		
⑰	PIP	Picture in picture
⑱	PIP AUDIO	To set the audio of in PIP mode
⑲	POSITION	To set the screen position in PIP mode
⑳	SOURCE	PIP Source
㉑	SWAP	Swap screen in PIP mode

< 5.10 > Options for Sunlight Readable : Auto Dimming

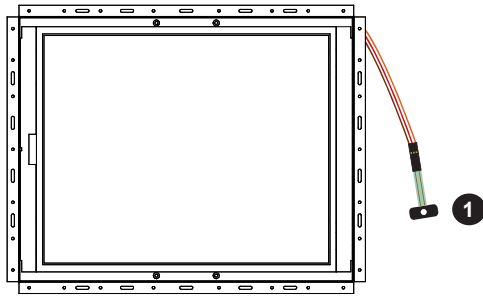

① **DA-01** Light sensor on **OP** model
(66cm from AD board to sensor end)

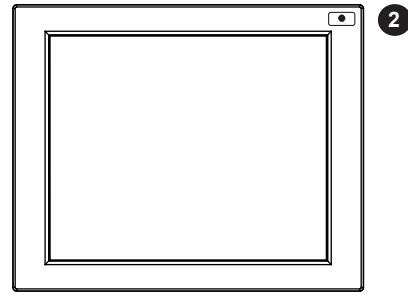

② **DA-01** Light sensor on **AP** model

DA-01 light sensor installed on the display front panel. Users can set auto dimming ON or OFF from OSD menu. Then display brightness changes according to its ambient brightness. Each change causes 10% increase or decrease on display brightness.

Once the auto dimming is ON, users cannot adjust brightness from OSD menu.

Steps : OSD Menu > Picture > Auto Dimming > ON

Light Sensor Operation Range

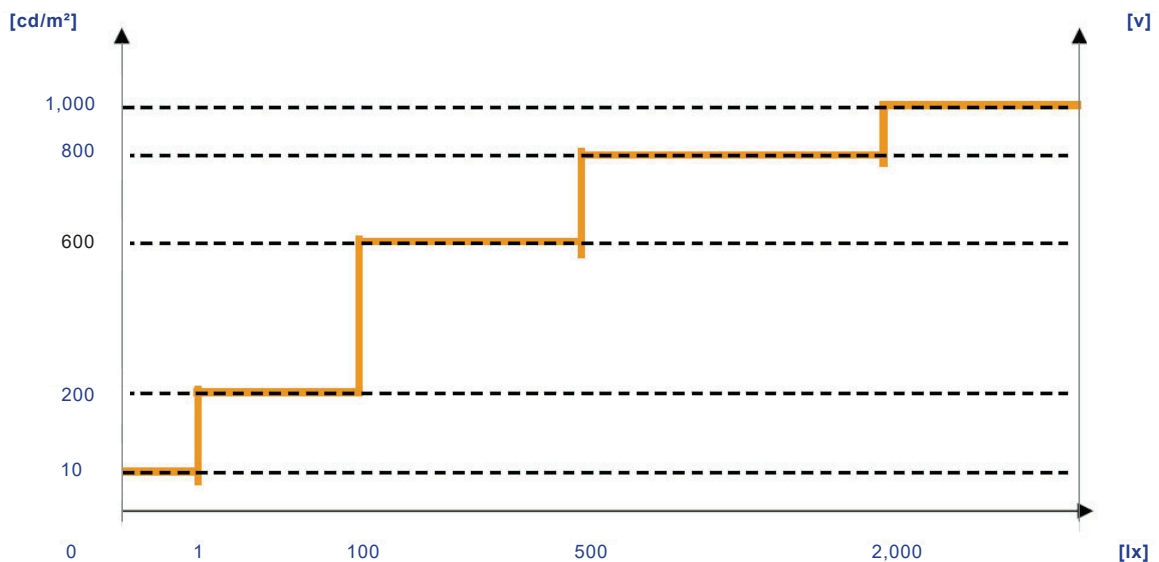

Options : Switch Dimming

DS-01 is a IP54 dimming knob installed on the bottom right side of the front panel. The display can support hyper dimming function to adjust brightness from nearly 0% to 100% via the easy-to-use knob. One click on dimming knob causes 2% increase or decrease on display brightness.

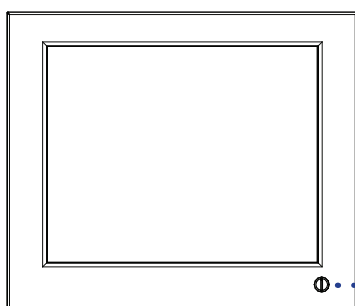

DS-01 dimming knob
Dimensions (W x H) : 15.5 x 14.2 mm

- For this option, front panel and casing dimensions may be changed.
- For HAP series, if DS-01 dimming knob applied, IP protection will be downgraded from IP65 to IP54.

< 6 > Ultraview 19" Family

19" LCD Display

250 cd/m² Brightness

6mm aluminum front bezel



AP-19

6mm aluminum front bezel
NEMA 4 / IP65 front protection

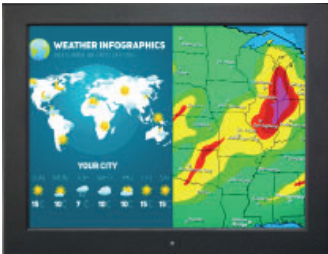

NAP-19

Aluminum front cover

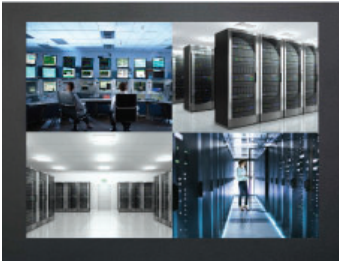

DP-19

Universal open frame



OP-19

MP-19

Industrial Display Kit

- 4:3 19" LED
- LCD controller
- AC power

1000 cd/m² Sunlight Readable Brightness

6mm aluminum front bezel



HAP-19

6mm aluminum front bezel
NEMA 4 / IP65 front protection



HNAP-19

Aluminum front cover



HDP-19

Universal open frame



HOP-19

The company reserves the right to modify product specifications without prior notice and assumes no responsibility for any error which may appear in this publication.

All brand names, logo and registered trademarks are properties of their respective owners.

Copyright 2020 Austin Hughes Electronics Ltd. All rights reserved.