

User Manual 2U Multi-Display Console Drawer



4K
ULHD

MRK-K17-2L

MRK-K17-3

MRK-K17-2R

1080p **60 Hz**

MRK-F17-2L

MRK-F17-3

MRK-F17-2R

1920 **1200**

MRK-X17-2L

MRK-X17-3

MRK-X17-2R

1280 **1024**

MRK-19-2L

MRK-19-3

MRK-19-2R

Designed and manufactured by Austin Hughes

751

Legal Information

First English printing, January 2022

Information in this document has been carefully checked for accuracy; however, no guarantee is given to the correctness of the contents. The information in this document is subject to change without notice. We are not liable for any injury or loss that results from the use of this equipment.

Safety Instructions

Please read all of these instructions carefully before you use the device. Save this manual for future reference.

- Unplug equipment before cleaning. Don't use liquid or spray detergent; use a moist cloth.
- Keep equipment away from excessive humidity and heat. Preferably, keep it in an air-conditioned environment with temperatures not exceeding 40° Celsius (104° Fahrenheit).
- When installing, place the equipment on a sturdy, level surface to prevent it from accidentally falling and causing damage to other equipment or injury to persons nearby.
- When the equipment is in an open position, do not cover, block or in any way obstruct the gap between it and the power supply. Proper air convection is necessary to keep it from overheating.
- Arrange the equipment's power cord in such a way that others won't trip or fall over it.
- If you are using a power cord that didn't ship with the equipment, ensure that it is rated for the voltage and current labeled on the equipment's electrical ratings label. The voltage rating on the cord should be higher than the one listed on the equipment's ratings label.
- Observe all precautions and warnings attached to the equipment.
- If you don't intend on using the equipment for a long time, disconnect it from the power outlet to prevent being damaged by transient over-voltage.
- Keep all liquids away from the equipment to minimize the risk of accidental spillage. Liquid spilled on to the power supply or on other hardware may cause damage, fire or electrical shock.
- Only qualified service personnel should open the chassis. Opening it yourself could damage the equipment and invalidate its warranty.
- If any part of the equipment becomes damaged or stops functioning, have it checked by qualified service personnel.

What the warranty does not cover

- Any product, on which the serial number has been defaced, modified or removed.
- Damage, deterioration or malfunction resulting from:
 - Accident, misuse, neglect, fire, water, lightning, or other acts of nature, unauthorized product modification, or failure to follow instructions supplied with the product.
 - Repair or attempted repair by anyone not authorized by us.
 - Any damage of the product due to shipment.
 - Removal or installation of the product.
 - Causes external to the product, such as electric power fluctuation or failure.
 - Use of supplies or parts not meeting our specifications.
 - Normal wear and tear.
 - Any other causes which does not relate to a product defect.
- Removal, installation, and set-up service charges.

Regulatory Notices Federal Communications Commission (FCC)

This equipment has been tested and found to comply with the limits for a Class B digital device, pursuant to Part 15 of the FCC rules. These limits are designed to provide reasonable protection against harmful interference in a residential installation.

Any changes or modifications made to this equipment may void the user's authority to operate this equipment. This equipment generates, uses, and can radiate radio frequency energy and, if not installed and used in accordance with the instructions, may cause harmful interference to radio communications.

However, there is no guarantee that interference will not occur in a particular installation. If this equipment does cause harmful interference to radio or television reception, which can be determined by turning the equipment off and on, the user is encouraged to try to correct the interference by one or more of the following measures:

- Re-position or relocate the receiving antenna.
- Increase the separation between the equipment and receiver.
- Connect the equipment into an outlet on a circuit different from that to which the receiver is connected.

Contents

< Part. 1 > MRK

1.1	Package Content	P.1
1.2	Structure Diagram & Dimension	P.1
1.3	Installation	P.4
1.4	Connection	P.8

< Part. 2 > Specifications / OSD

2.1	Product Specifications	P.10
2.2	Keyboard / Mouse Specifications	P.16
2.3	On-screen Display Operation (OSD)	P.19

< Part. 3 > Options

3.1	3G / HD / SD-SDI Broadcast-grade input	P.22
3.2	HDMI video input	P.23
3.3	Projected Capacitive (10-point touch) Capacitive (1-point touch) Resistive (1-point touch)	P.24
3.4	DC Power : 12V / 24V / 48V / 125V	P.26

Before Installation

- It is very important to mount the equipment in a suitable cabinet or on a stable surface.
- Make sure the place has a good ventilation, is out of direct sunlight, away from sources of excessive dust, dirt, heat, water, moisture and vibration.

Unpacking

The equipment comes with the standard parts shown in package content. Check and make sure they are included and in good condition. If anything is missing, or damaged, contact the supplier immediately.

How To Clean Your LCD Monitor



Caution :

- To avoid the risk of electric shock, make sure your hands are dry before unplugging your monitor from or plugging your monitor into an electrical outlet.
- When you clean your monitor, do not press down on the LCD screen. Pressing down on the screen can scratch or damage your display. Pressure damage is not covered under warranty.
- Use only cleansers made specifically for cleaning monitors and monitor screens. Cleansers not made to clean monitors and monitor screens can scratch the LCD display or strip off the finish.
- Do not spray any kind of liquid directly onto the screen or case of your monitor. Spraying liquids directly onto the screen or case can cause damage which is not covered under warranty.
- Do not use paper towels or abrasive pads to clean your monitor. Using an abrasive pad or any wood based paper product such as paper towels can scratch your LCD screen.

Cleaning Your Monitor

To clean your LCD safely, please follow these steps :

- ① Disconnect the power cord.
- ② Gently wipe the surface using a clean, dry microfiber cloth. Use as little pressure as possible.

Cleaning Tough Marks and Smudges

To remove tough marks and smudges, please follow these steps :

- ① Disconnect the power cord.
- ② Spray a small amount of non-abrasive cleanser on a microfiber cloth.



Caution : Do not spray or apply any liquids directly onto the monitor. Always apply the solution to your microfiber cloth first, not directly on the parts you are cleaning.

- ③ Gently wipe the surface. Use as little pressure as possible.
- ④ Wait until your monitor is completely dry before plugging it in and powering it up.

< Part 1 >

< 1.1 > Package Content



MRK-K17 unit X 1

- 6ft DP cable X 2 or 3
- USB (B) to (A) cable X 1
- Power adapter & Power cord X 1
- M6 screw, cage nut & cup washer X 8

MRK-F17 /

MRK-X17 / MRK-19 unit X 1

- 6ft DVI cable X 2 or 3
- USB keyboard cable X 1
- Power adapter & Power cord X 1
- M6 screw, cage nut & cup washer X 8

 The above package content is only for the single console models.
It varies with options such as SDI & DC power.

< 1.2 > Structure Diagram

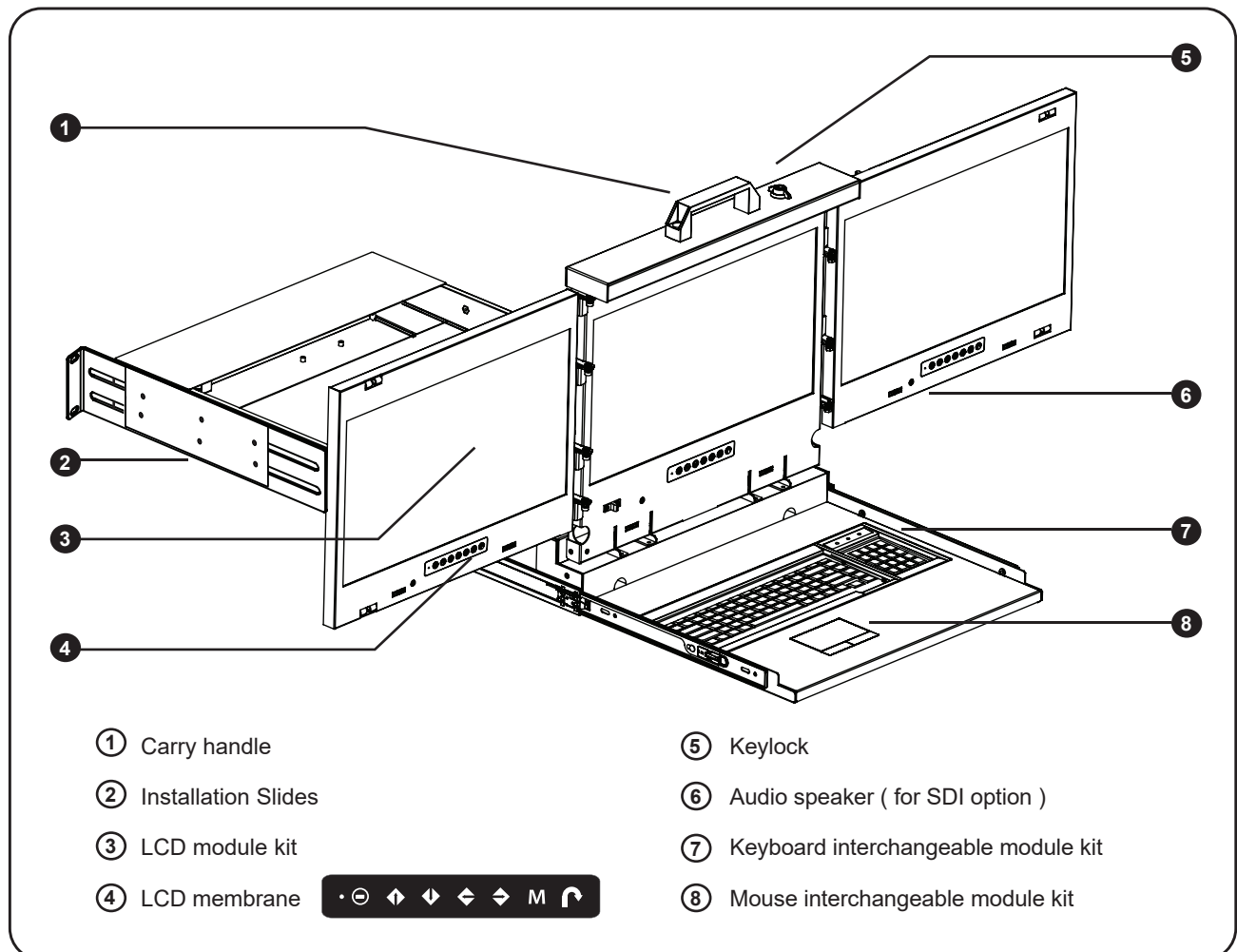

< 1.2 > MRK-K17 / MRK-F17 / MRK-X17 Dimension

1mm = 0.03937 inch

Front View

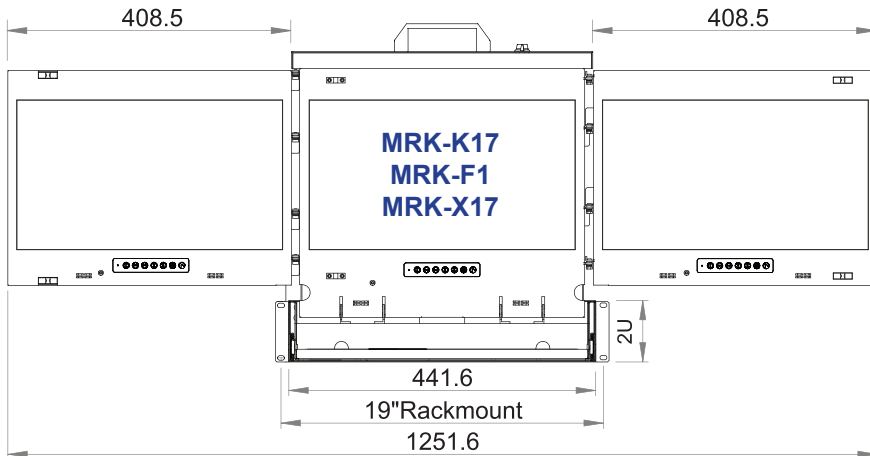

Triple display



Dual display (LH mounted)



Dual display (RH mounted)



Rear View

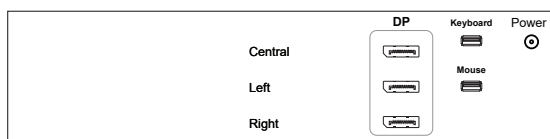

MRK-K17

MRK-F17 / MRK-X17

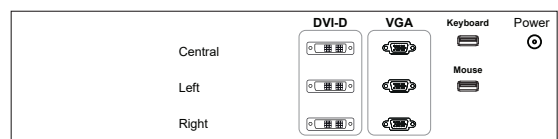

Side View

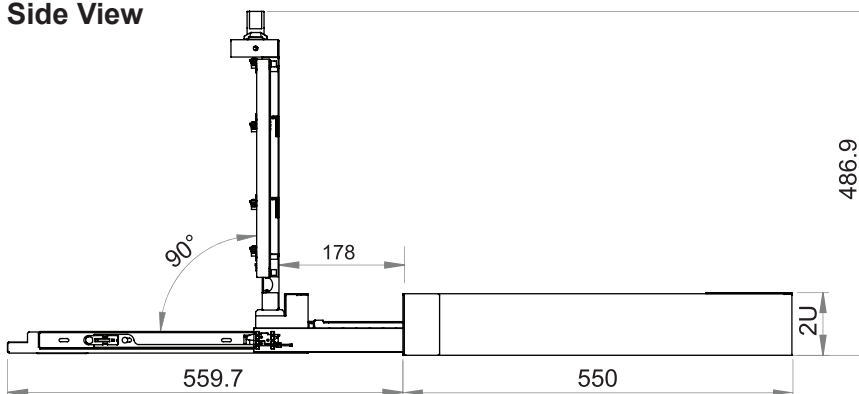

Top View

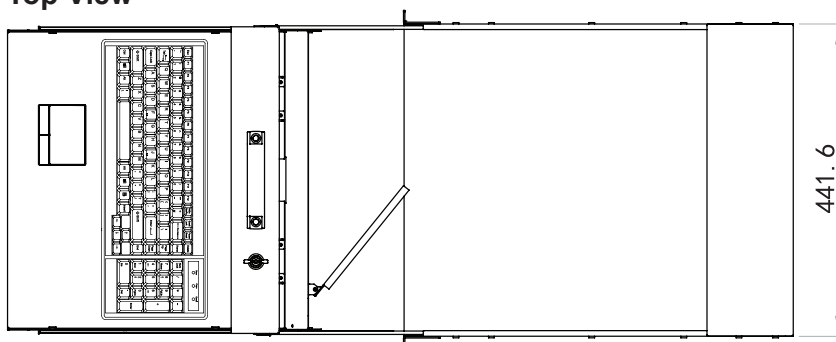

Model	Display	Product Dimension (W x D x H)	Packing Dimension (W x D x H)	Net Weight	Gross Weight	
MRK-K17	-3	Triple	441.6 x 550 x 88 mm 17.4 x 21.7 x 3.5 inch	580 x 683 x 197 mm 22.8 x 26.9 x 7.8 inch	25.7 kg 56.5 lb	31.1 kg 68.4 lb
MRK-F17	-2L	Dual LH mounted	441.6 x 550 x 88 mm 17.4 x 21.7 x 3.5 inch	580 x 683 x 197 mm 22.8 x 26.9 x 7.8 inch	21 kg 46.2 lb	26 kg 57.2 lb
MRK-X17	-2R	Dual RH mounted	441.6 x 550 x 88 mm 17.4 x 21.7 x 3.5 inch	580 x 683 x 197 mm 22.8 x 26.9 x 7.8 inch	21 kg 46.2 lb	26 kg 57.2 lb



The weight is only for the single console models. It varies with accessories & options .

< 1.2 > MRK-19 Dimension

1mm = 0.03937 inch

Front View

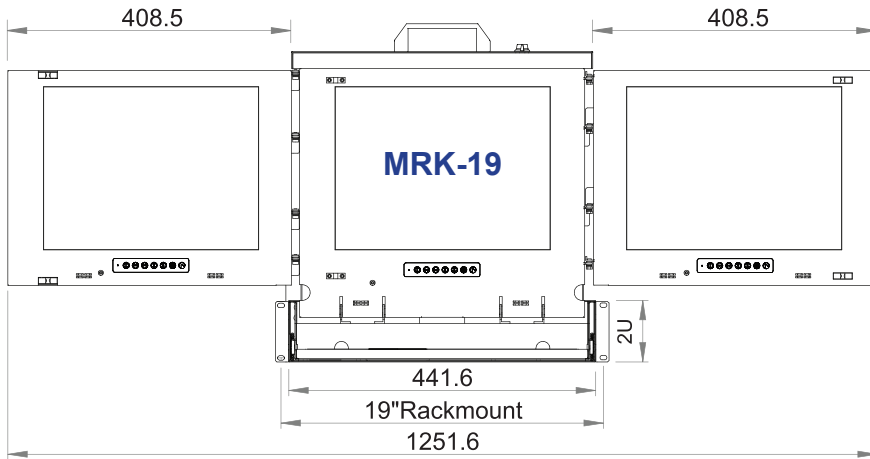

Triple display



Dual display (LH mounted)



Dual display (RH mounted)



Rear View

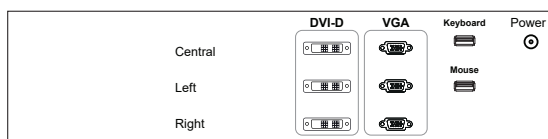

Side View

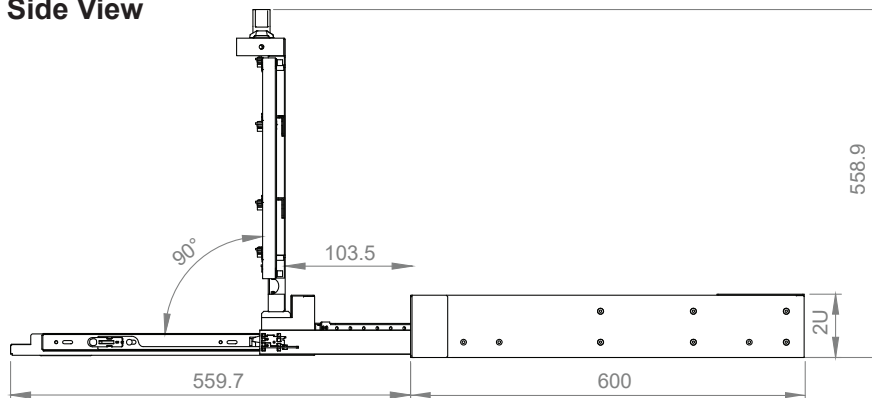

Top View

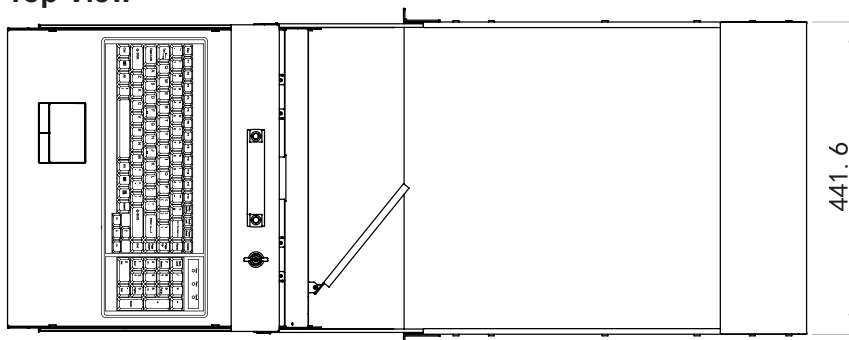

Model	Display	Product Dimension (W x D x H)	Packing Dimension (W x D x H)	Net Weight	Gross Weight
MRK-19	-3 Triple	441.6 x 600 x 88 mm 17.4 x 23.6 x 3.5 inch	580 x 683 x 197 mm 22.8 x 26.9 x 7.8 inch	26.7 kg 58.7 lb	32.1 kg 70.6 lb
	-2L Dual LH mounted	441.6 x 600 x 88 mm 17.4 x 23.6 x 3.5 inch	580 x 683 x 197 mm 22.8 x 26.9 x 7.8 inch	22 kg 48.4 lb	27 kg 59.4 lb
	-2R Dual RH mounted	441.6 x 600 x 88 mm 17.4 x 23.6 x 3.5 inch	580 x 683 x 197 mm 22.8 x 26.9 x 7.8 inch	22 kg 48.4 lb	27 kg 59.4 lb



The weight is only for the single console models. It varies with accessories & options .

< 1.3 > Installation - How to install Installation Slides

Step 1

- The left and right rear mounting brackets are attached to the Multi-display console drawer.

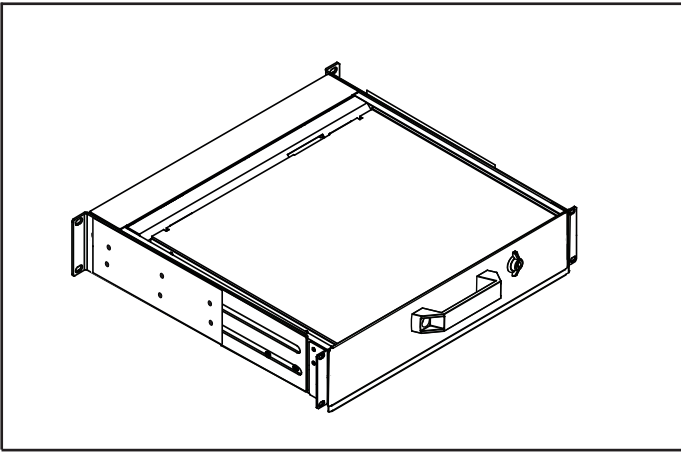

Step 2

- Measure the depth of the front and rear mounting rails.
- Align each rear mounting bracket to a suitable length.
- Mounting distance : 550 - 790 mm

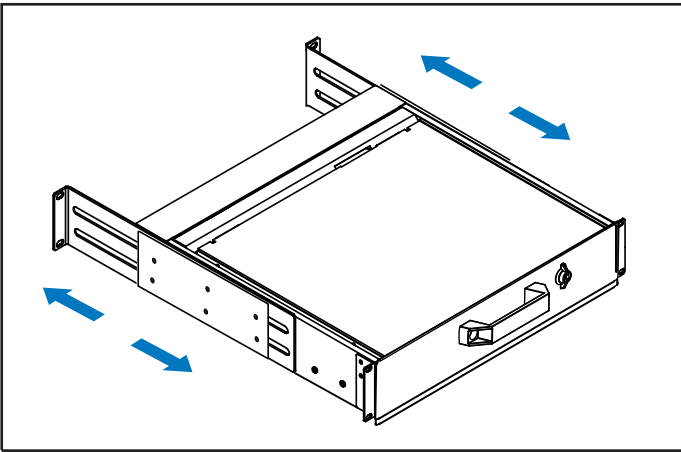

Step 3

Complete the installation

- Fix the Multi-display console drawer into the rack.

 M6 screw, cage nut & cup washer x 8 are provided.

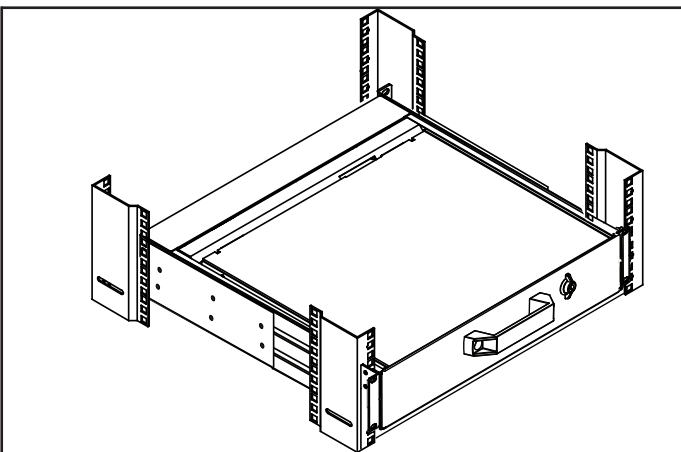

< 1.3 > Installation - How to Use the **Multi-Display** Drawer



Step 1

- Unlock the key cylinder to 3 o'clock direction.



Step 2

- Hold the handle and slide out the drawer.



Step 3

- Flip up the LCD to a suitable angle.



Step 4

- Open the **Left** / **Right** display.

< 1.3 > Installation - How to Use the **Multi-Display** **Drawer**



Step 5

- Operate the multi-display drawer.



Step 6

- Close the **Left** / **Right** display.
- Flip down the LCD completely.



Step 7

- Must completely extend the drawer before returning it to the park position.
- Then pull and hold both side release buttons when pushing the drawer back to the rack.

 **The above steps are necessary.**
Failure to complete these will cause damage.



Step 8

- Return the multi-display drawer to park position.

< 1.3 > Installation - How to Use the Slides

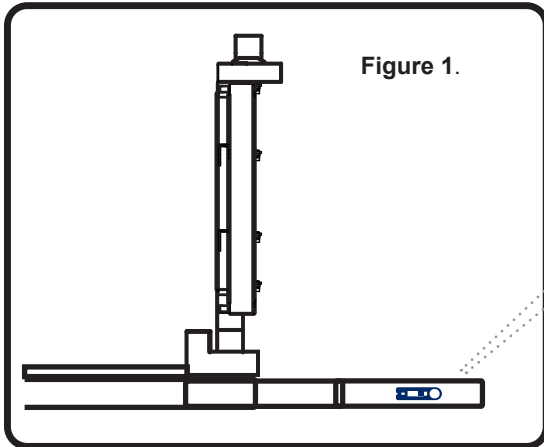

- A purple release button is located on the front of the slide. (shown in **Figure 1**).

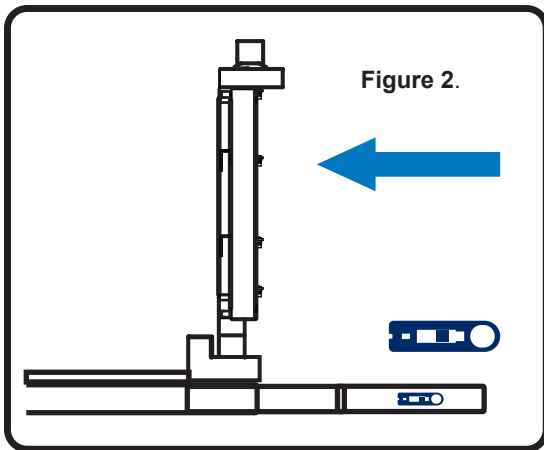

- Pull and hold both side release buttons when pushing the Multi display console drawer back to the rack. (shown in **Figure 2**).

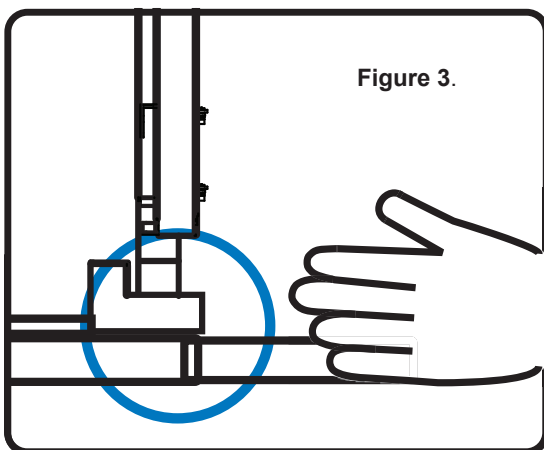

- ⚠ **Caution** : Keep your fingers away from the slide stop. (shown in **Figure 3**).

< 1.4 > MRK-K17 connection to DP Server

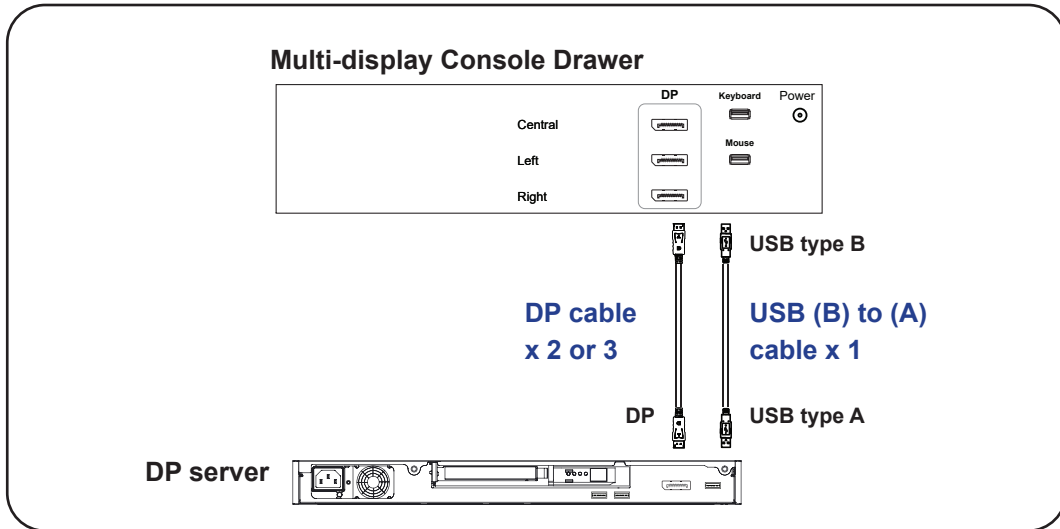

* DP cable x 2 and USB (B) to (A) cable x 1 for dual display



Caution : The LCD console drawer is hot-pluggable, but components of connected devices, such as the servers and KVM switch, may not be hot-pluggable. Plugging and unplugging cables while servers and KVM are powered on may cause irreversible damage to the servers, KVM and LCD console drawer. Before attempting to connect anything to the LCD console drawer, we suggest turning off the power to all devices. Apply power to connected devices again only after the LCD console drawer is receiving power. The company is not responsible for damage caused in this way.

< 1.4 > MRK-F17 / MRK-X17 / MRK-19 connection to **USB Server**

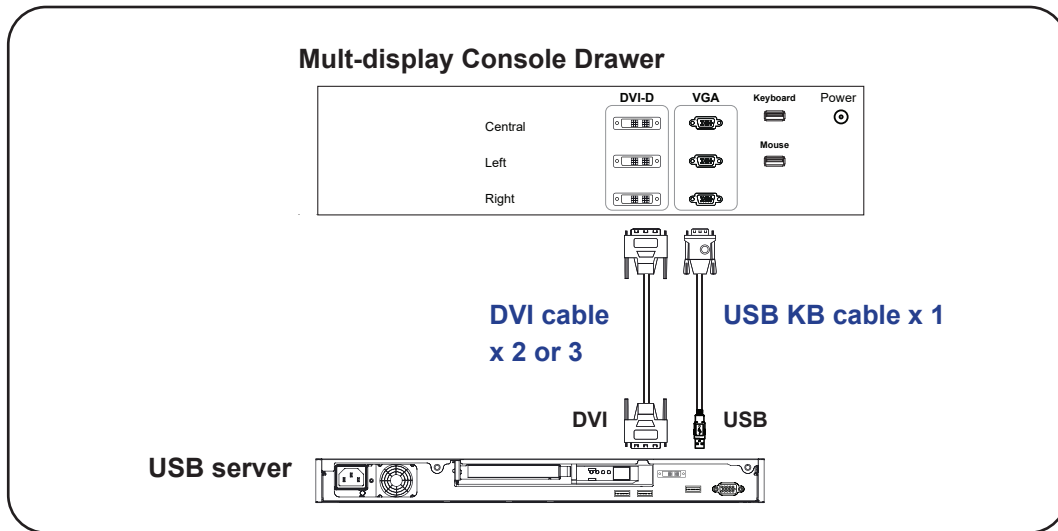

* DVI cable x 2 and USB KB cable x 1 for dual display



Caution : The LCD console drawer is hot-pluggable, but components of connected devices, such as the servers and KVM switch, may not be hot-pluggable. Plugging and unplugging cables while servers and KVM are powered on may cause irreversible damage to the servers, KVM and LCD console drawer. Before attempting to connect anything to the LCD console drawer, we suggest turning off the power to all devices. Apply power to connected devices again only after the LCD console drawer is receiving power. The company is not responsible for damage caused in this way.

< Part 2 >

< 2.1 > Product Specifications - MRK-K17

LCD Panel	MRK-K17		
	Native Resolution	3840 x 2160@60Hz	
	Panel Size (diagonal)	17.3-inch TFT color LCD	
	Brightness (cd/m ²)	400	
	Contrast Ratio (typ.)	1000:1	
	Colors	16.7 M, 8-bit	
	Viewing Angle (L/R/U/D)	89/89/89/89	
	Response Time (ms)	Max. 16	
	Dot pitch (mm)	0.0995	
	Display Area (mm)	382.12H x 214.94V	
	Surface treatment	Anti-glare	
	Surface hardness	3H	
	Backlight Type	LED	
	MTBF (hrs)	15,000	

Video	Package	DP 1.2 / HDCP 1.3
	Option	HDMI 2.0 / HDCP 2.2

Power	Power Supply	Range	Auto-sensing 100 to 240VAC, 50 / 60Hz
	Power Consumption	Screen ON	Max. 21W
		Power saving mode	Max. 2W
		Power button OFF	Max. 1W

Compliance	EMC	FCC & CE certified
	Safety	CE / LVD certified
	Environment	RoHS3 & REACH compliant

Environmental Conditions	Operating	Temperature	0 to 55°C degree
		Humidity	20~90%, non-condensing
		Altitude	16,000 ft
	Storage / Non-operating	Temperature	-20 to 60°C degree
		Humidity	5~90%, non-condensing
		Altitude	40,000 ft
		Shock	10G acceleration (11ms duration)
		Vibration	10~300Hz 0.5G RMS random

< 2.1 > Product Specifications - MRK-K17

Physical Specification	Product (W x D x H)		mm	441.6 x 550 x 88	
			inch	17.4 x 21.7 x 3.5	
	Packing (W x D x H)		mm	580 x 683 x 197	
			inch	22.8 x 26.9 x 7.8	
	Weight	Net	Triple display	25.7 kg / 56.5 lb	
			Dual display	21 kg / 46.2 lb	
Gross		Triple display	31.1 kg / 68.4 lb		
		Dual display	26 kg / 57.2 lb		

* All dimensions stated are subject to change if options are selected / integrated to base model part codes

Applicable Format	Display Port Input	PC Signal	3840 x 2160 x 60Hz
			1920 x 1080 x 60Hz
			1600 x 1200 x 60Hz
			1360 x 768 x 60Hz
			1280 x 1024 x 60 / 75Hz
			1280 x 768 x 60Hz
			1024 x 768 x 60 / 70 / 75Hz
			800 x 600 x 60 / 72 / 75Hz
			720 x 400 x 70Hz
			640 x 480 x 60 / 72 / 75Hz
	Audio Signal	2ch Linear PCM	
	HDMI Input	HDMI 2.0	3840 x 2160 x 60Hz
			HDMI 2.0 / 1.4
			1920 x 1080 x 50 / 60Hz (1080p)
			1920 x 1080 x 25 / 30Hz (1080i)
			1280 x 720 x 50 / 60Hz (720p)
		720 x 480 x 50 / 60Hz (576p / 480p)	
	Audio Signal	2ch Linear PCM	

* In some circumstances, if the user connects the LCD to PC via HDMI port or video and audio signals, the LCD may display incorrectly on a full screen. If so, please adjust the display card setting on display size to fix the issue.

< 2.1 > Product Specifications - MRK-F17

LCD Panel		MRK-F17
	Native Resolution	1920 x 1080
	Panel Size (diagonal)	17.3"
	Standard Brightness (cd/m ²)	300
	High Brightness (cd/m ²) - Option	1000
	Contrast Ratio (typ.)	1000:1
	Colors	16.7 M, 8-bit
	Viewing Angle (L/R/U/D)	80/80/60/80
	Response Time (ms)	5.5
	Dot pitch (mm)	0.1989
	Display Area (mm)	381.888H x 214.812V
	Surface treatment	Anti-glare, Hard-coating
	Surface hardness	3H
	Backlight Type	LED
MTBF (hrs)	15,000	

Video	Package	DVI-D + VGA
	Option	HDMI 1.4 / HDCP 1.4 or DP 1.0 / HDCP 1.3

Power	Power Supply	Range	Auto-sensing 100 to 240VAC, 50 / 60Hz
	Power Consumption	Screen ON	Max. 14W
		Power saving mode	Max. 2W
		Power button OFF	Max. 1W

Compliance	EMC	FCC & CE certified
	Safety	CE / LVD certified
	Environment	RoHS3 & REACH compliant

Environmental Conditions	Operating	Temperature	0 to 55°C degree
		Humidity	20~90%, non-condensing
		Altitude	16,000 ft
	Storage / Non-operating	Temperature	-20 to 60°C degree
		Humidity	5~90%, non-condensing
		Altitude	40,000 ft
		Shock	10G acceleration (11ms duration)
		Vibration	10~300Hz 0.5G RMS random

< 2.1 > Product Specifications - MRK-F17

Physical Specification	Product (W x D x H)	mm	441.6 x 550 x 88	
		inch	17.4 x 21.7 x 3.5	
	Packing (W x D x H)	mm	580 x 683 x 197	
		inch	22.8 x 26.9 x 7.8	
	Net Weight	Triple display		25.7 kg / 56.5 lb
		Dual display		21 kg / 46.2 lb
	Gross Weight	Triple display		31.1 kg / 68.4 lb
		Dual display		26 kg / 57.2 lb

* All dimensions stated are subject to change if options are selected / integrated to base model part codes

Applicable Format	DVI-D / VGA Input	PC Signal	1920 x 1080 x 60Hz	
			1680 x 1050 x 60Hz	
			1440 x 900 x 60Hz	
			1360 x 768 x 60Hz	
			1280 x 1024 x 60Hz	
			1280 x 768 x 60Hz	
			1280 x 720 x 60Hz	
			1152 x 864 x 60Hz	
			1024 x 768 x 60Hz	
			800 x 600 x 60Hz	
	640 x 480 x 60Hz			
		Audio Signal	2ch Linear PCM	
	HDMI Input	PC Signal	Same as VGA	
			HDMI 1.4	1920 x 1080 x 50 / 60Hz (1080p)
				1920 x 1080 x 25 / 30Hz (1080i)
				1280 x 720 x 50 / 60Hz (720p)
			720 x 480 x 50 / 60Hz (576p / 480p)	
		Audio Signal	2ch Linear PCM	
	Display port Input	PC Signal	1920 x 1080 x 60Hz	
			1680 x 1050 x 60Hz	
			1440 x 900 x 60Hz	
1360 x 768 x 60Hz				
1280 x 1024 x 60Hz				
1280 x 768 x 60Hz				
1280 x 720 x 60Hz				
1152 x 864 x 60Hz				
1024 x 768 x 60Hz				
800 x 600 x 60Hz				
640 x 480 x 60Hz				
	Audio Signal	2ch Linear PCM		

* In some circumstances, if the user connects the LCD to PC via HDMI port or video and audio signals, the LCD may display incorrectly on a full screen. If so, please adjust the display card setting on display size to fix the issue.

< 2.1 > Product Specifications - MRK-X17 / MRK-19

LCD Panel		MRK-X17	MRK-19
	Native Resolution	1920 x 1200	1280 x 1024
	Panel Size (diagonal)	16.2"	19"
	Standard Brightness (cd/m ²)	300	250
	High Brightness (cd/m ²) - Option	/	1000
	Contrast Ratio (typ.)	600:1	1000:1
	Colors	16.7 M, 8-bit	16.7 M
	Viewing Angle (L/R/U/D)	89/89/89/89	85/85/80/80
	Response Time (ms)	30	5
	Dot pitch (mm)	0.191	0.294
	Display Area (mm)	383.8H x 214.9V	337.92H x 270.33V
	Surface treatment	Anti-glare, Hard-coating	Haze 25%, Hard-coating
	Surface hardness	3H	3H
	Backlight Type	LED	LED
MTBF (hrs)	20,000	30,000	

Video	Package	DVI-D + VGA	DVI-D + VGA
	Option	HDMI 1.4 / HDCP 1.4	HDMI 1.2 / HDCP 1.1

Power	Power Supply	Range	Auto-sensing 100 to 240VAC, 50 / 60Hz		
	Power Consumption	Screen ON		Max. 25W	Max. 22W
		Power saving mode		Max. 2W	Max. 2W
		Power button OFF		Max. 1W	Max. 1W

Compliance	EMC	FCC & CE certified
	Safety	CE / LVD certified
	Environment	RoHS3 & REACH compliant

Environmental Conditions	Operating	Temperature	0 to 55°C degree	
		Humidity	20~90%, non-condensing	
		Altitude	16,000 ft	
	Storage / Non-operating	Temperature	-20 to 60°C degree	
		Humidity	5~90%, non-condensing	
		Altitude	40,000 ft	
		Shock	10G acceleration (11ms duration)	
		Vibration	10~300Hz 0.5G RMS random	

< 2.1 > Product Specifications - MRK-X17 / MRK-19

Physical Specification	Product (W x D x H)	MRK-X17	mm	441.6 x 550 x 88
			inch	17.4 x 21.7 x 3.5
		MRK-19	mm	441.6 x 600 x 88
			inch	17.4 x 23.6 x 7.8
	Packing (W x D x H)		mm	580 x 683 x 197
			inch	22.8 x 26.9 x 7.8
	Net Weight	MRK-X17	Triple display	25.7 kg / 56.5 lb
			Dual display	21 kg / 46.2 lb
		MRK-19	Triple display	26.7 kg / 58.7 lb
			Dual display	22 kg / 48.4 lb
Gross Weight	MRK-X17	Triple display	31.1 kg / 68.4 lb	
		Dual display	26 kg / 57.2 lb	
	MRK-19	Triple display	32.1 kg / 70.6 lb	
		Dual display	27 kg / 59.4 lb	

* All dimensions stated are subject to change if options are selected / integrated to base model part codes

Applicable Format	DVI-D / VGA Input	PC Signal	1920 x 1200 x 60Hz (MRK-X17 only)
			1400 x 1050 x 60Hz (MRK-X17 only)
			1440 x 900 x 60Hz (MRK-X17 only)
			1360 x 768 x 60Hz (MRK-X17 only)
			1280 x 1024 x 60 / 75Hz
			1280 x 960 x 60Hz
			1280 x 768 x 60 / 75Hz
			1152 x 864 x 75Hz
			1024 x 768 x 60 / 70 / 75Hz
			848 x 480 x 60Hz
			800 x 600 x 60 / 72 / 75Hz
			720 x 400 x 70Hz
			640 x 480 x 60 / 72 / 75Hz
			640 x 400 x 70Hz
	640 x 350 x 70Hz		
		Audio Signal	2ch Linear PCM
HDMI Input	PC Signal	Same as VGA	
		HDMI 1.2 / 1.4	1920 x 1080 x 50 / 60Hz (1080p) (MRK-X17 only)
			1920 x 1080 x 25 / 30Hz (1080i) (MRK-X17 only)
			1280 x 720 x 50 / 60Hz (720p)
		720 x 480 x 50 / 60Hz (576p / 480p)	
	Audio Signal	2ch Linear PCM	

* In some circumstances, if the user connects the LCD to PC via HDMI port or video and audio signals, the LCD may display incorrectly on a full screen. If so, please adjust the display card setting on display size to fix the issue.

< 2.2 > Standard Keyboard / Mouse Specifications

Ge G keyboard integrated with touchpad

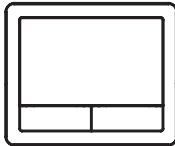
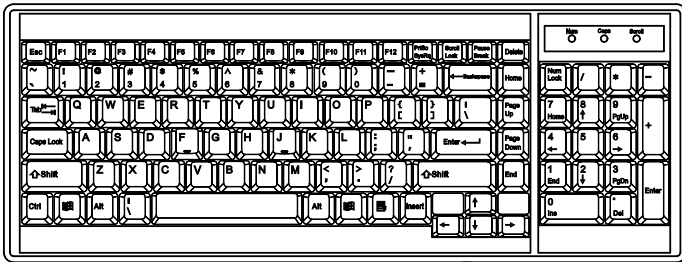

Gb G keyboard integrated with trackball

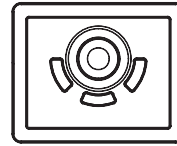
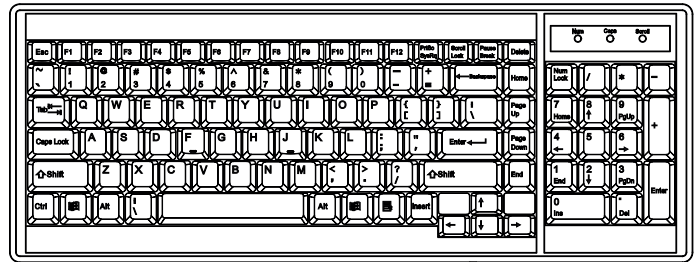

Key force	55 ± 5g
Travelling distance	3 ± 0.3mm
Switch life	> 10 million life cycle time
OS support	Windows / Linux / Unix / Mac OS

Supporting layouts

America



United States

EMEA



United Kingdom



Germany



France



Spain



Italy

Asia



Japan



Korea

< 2.2 > MAC Keyboard / Mouse Options

Me MAC keyboard integrated with touchpad

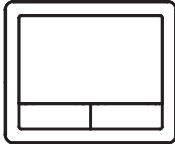
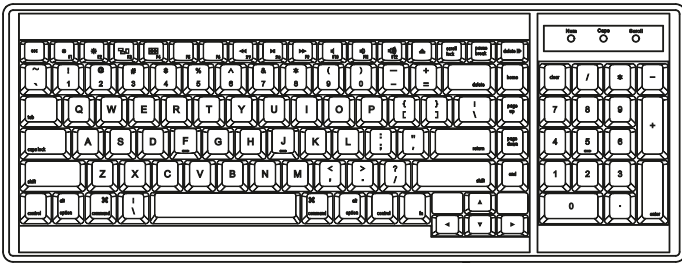

Mb MAC keyboard integrated with trackball

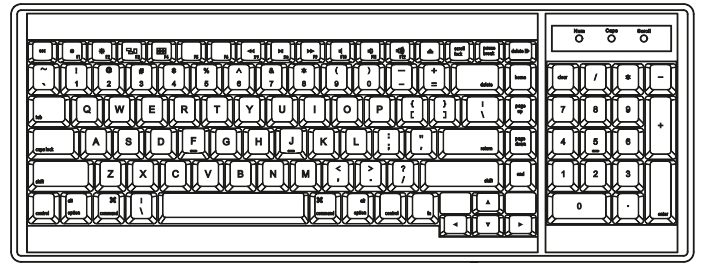

Supporting layouts

America 
United States

How to Use "MAC" Keyboard

Keyboard Features

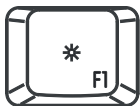

F1
Decrease display brightness

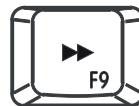

F9
Fast-forward

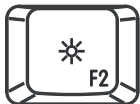

F2
Increase display brightness

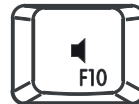

F10
Mute sound



F3
Mission control
* Only works with OS X Lion
default Keyboard Shortcuts.

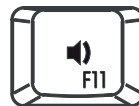

F11
Decrease volume



F4
Dashboard



F12
Increase volume



F7
Rewind

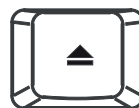

Eject disc



F8
Play / Pause



Command

< 2.2 > SUN Keyboard / Mouse Options

Se S keyboard integrated with touchpad

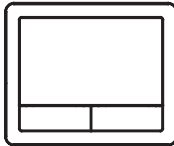
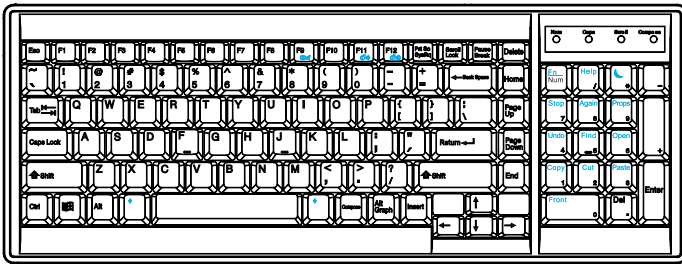

Sb S keyboard integrated with trackball

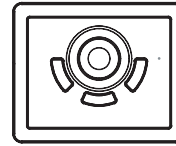
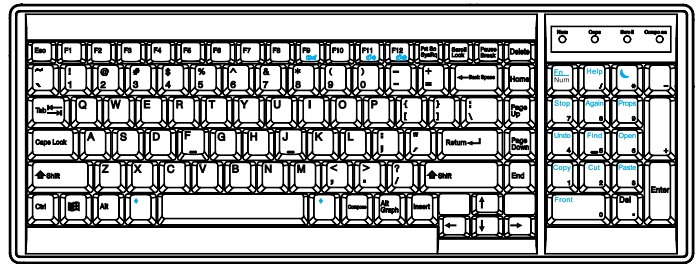

S keyboard integrated with touchpad / trackball



- Incorporates SUN keys, including Stop, Cut, Paste, Compose, Copy and Help
- 104 key notepad keyboard with full numerical pad and SUN function
- USB interface
- US layout only

How to Use "S" Keyboard

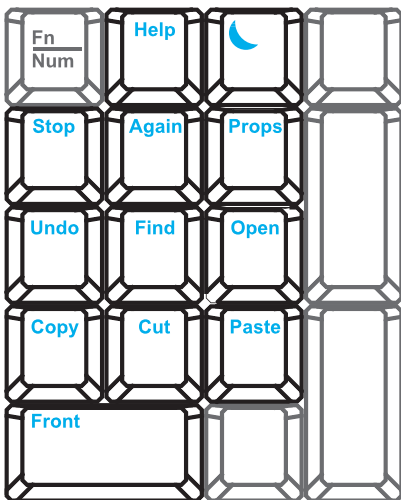

Num LED in Off mode

Key pad behaves as a SUN Solar system administration command mode

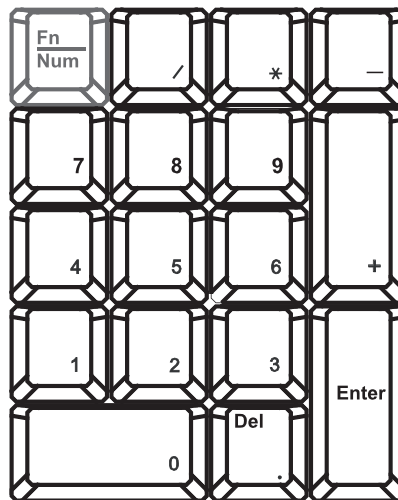

Num LED in Green mode

Key pad behaves as a normal key pad mode

Audio / Display Keys

* Please ask your supplier for full details

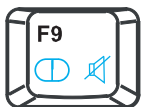

F9
Audio : Mute
Display : Degauss

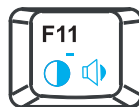

F11
Audio : Decrease volume
Display : Decrease contrast

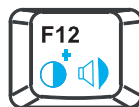



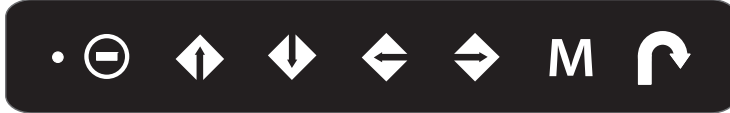

F12
Audio : Increase volume
Display : Increase contrast

< 2.3 > On-screen Display Operation (OSD)

- Power light
- Green = On
- Orange = Power saving



Membrane Switch	Function
	Power on / off LCD
	Display the OSD menu
	Scrolls through menu options and adjusts the displayed control (To auto adjustment by pressing the button  for 5 seconds)
	Exit the OSD screen Toggle analog, digital & video connection (DVI-D and video options only)

< 2.3 > On-screen Display Operation (OSD)

① Picture

Brightness : Adjust the screen brightness

Contrast : Adjust the difference between the image background (black level) and the foreground (white level)

Black level : Adjust background black level of the screen

Eco : Screen in power saving mode

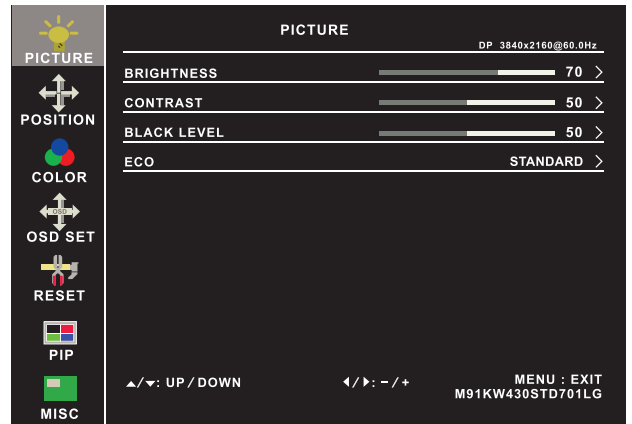

② Position

Picture size : Adjust the image size
- Full Screen / 4:3 / 5:4 / Pixel to Pixel

DP version : Select the DP version

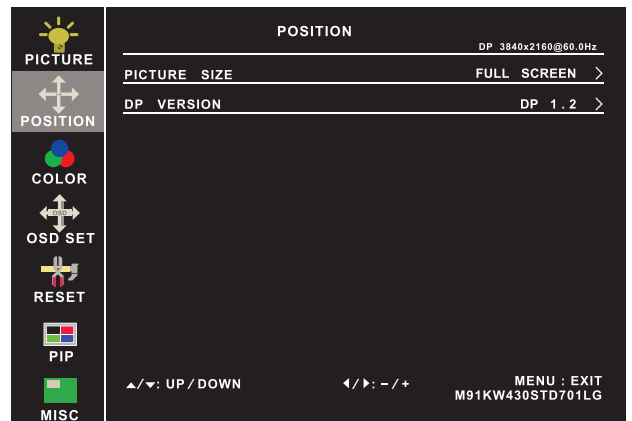

③ Color

Color temperature : User / Warm / Cool / 5400k mode and Red / Green / Blue color balance

Sharpness : Adjust the image from weak to sharp

Hue : Adjust the screen hue value

Saturation : Adjust the saturation of the image color

Dynamic

luminous control : Control the dynamic brightness

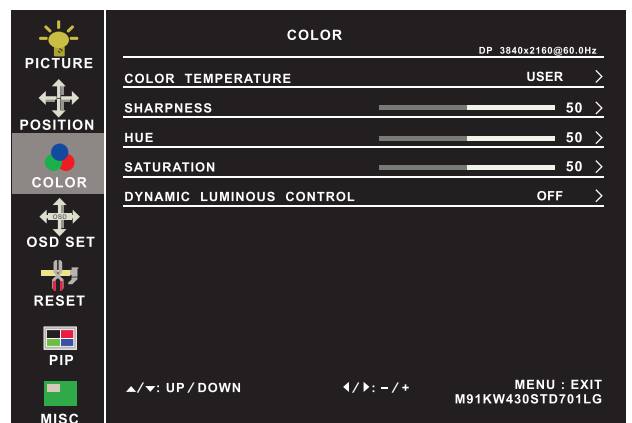

④ OSD Set

Language : Select the language in which the OSD menu is displayed - English

OSD H-Position : Align the screen image left or right

OSD V-Position : Align the screen image up or down

OSD time out : Adjust the screen timeout

OSD transparency : Adjust the screen transparency

OSD size : Adjust the screen size - Normal / Small

OSD rotation : Rotate the screen - 90° / 180° / 270°

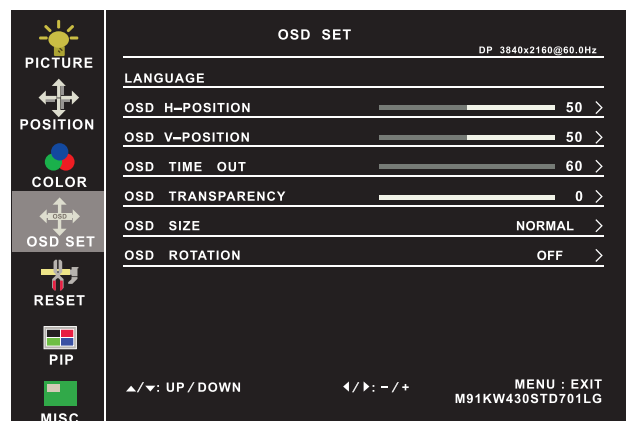

< 2.3 > On-screen Display Operation (OSD)

⑤ Reset

Reset : Return the adjustment back to factory setting

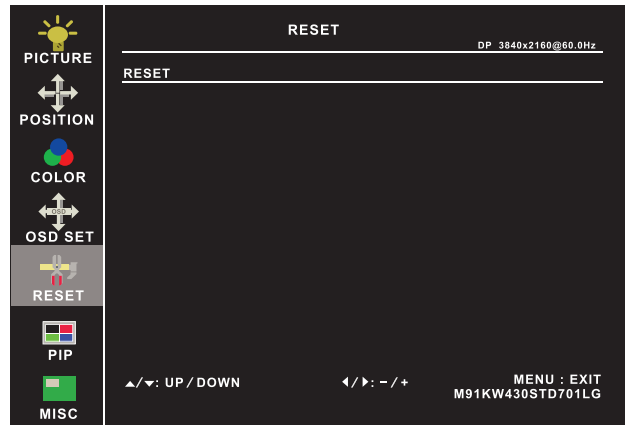

⑥ PIP (Not Applicable to F17)

PIP mode : Enter into PIP / PBP setting - PIP MODE / PBP 2WIN (Main screen + 1 sub screen) / PBP 3WIN (Main screen + 2 sub screen) / PBP 4WIN (Main screen + 3 sub screen)
Select the signal input of each sub screen

PIP size : Adjust the size of the Sub screen
- Small / Medium / Large / Huge

PIP position : Adjust the position of the Sub screen
- Top Left / Top Right / Bottom Left / Bottom Right

Swap : Swap the input signal of PIP / PBP sub screen

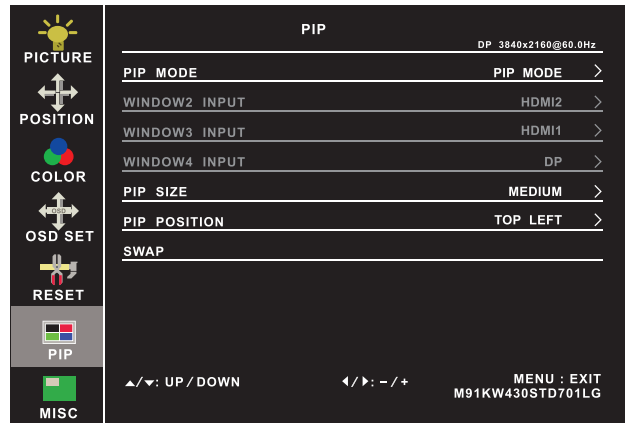

⑦ MISC

Signal source : Select the signal source - DP / HDMI1 / HDMI2

Mute : Turn off the surrounding sound

Audio in : Auto / Line in / DP

Volume : Adjust the volume of sound

Sleep mode : Set the off time - 10 min / 20 min / 30 min / 50 min / 60 min / 120 min / 240 min

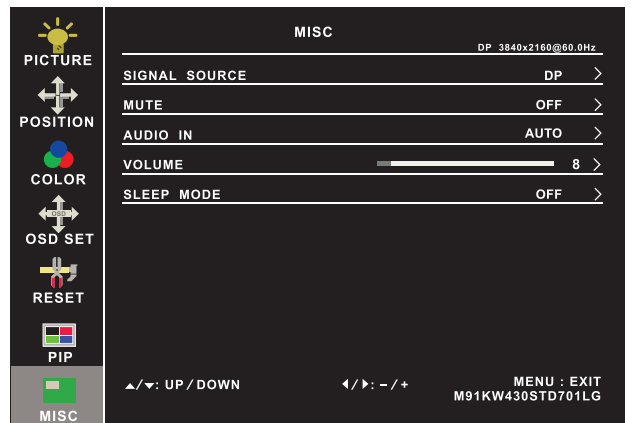

Options on Reset page

Rotation : Rotate the image in Full screen or 1:1
- 90° / 180° / 270°

Picture size : Adjust the image size in Full screen or 1:1

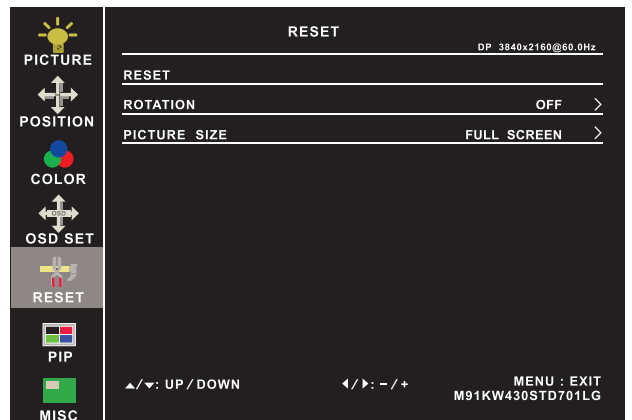

< Part 3 >

< 3.1 > Options : 3G / HD / SD-SDI input

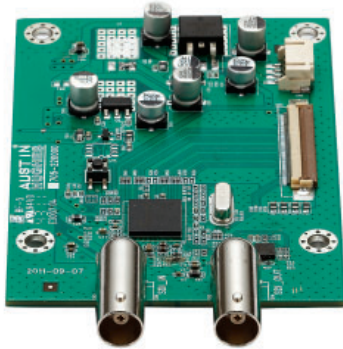

SDI

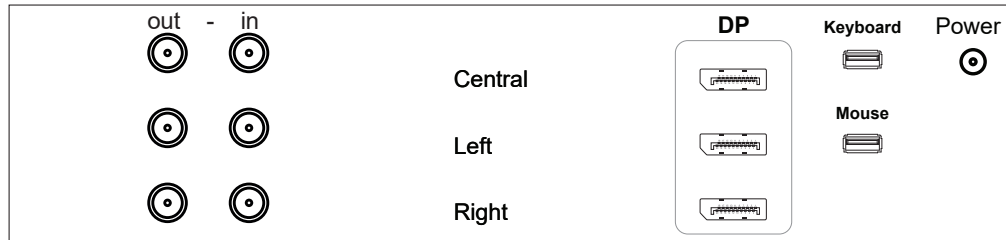

MRK-F17 / MRK-X17 / MRK-19

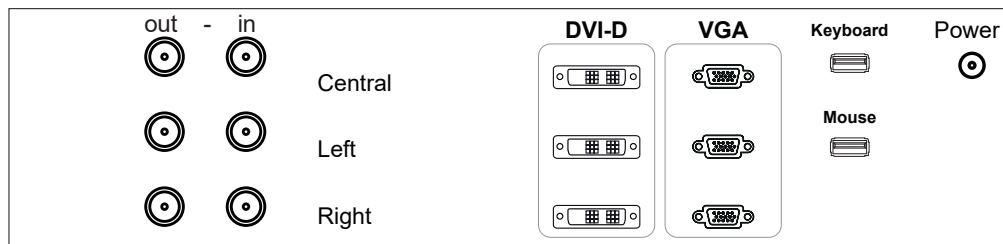

INPUT	3G-SDI IN	BNC x 1 / 0.8Vp-p (75 ohm)
	3G-SDI OUT	BNC x 1 / Active through, equalized & relocked

Standard Compliance	Video	SMPTE 425M / 274M / 296M / 125M ITU-R BT.656
	Audio	SMPTE 299M / 272M-C

Compatible Video Format	3G-SDI	1080p @60 / 50Hz, 4:2:2
		1080p @30 / 25 / 24Hz, 4:4:4
		1080i @60 / 50Hz, 4:4:4
		720p @60 / 50Hz, 4:4:4
	HD-SDI	1080p @30 / 25 / 24Hz, 4:2:2
		1080i @60 / 50Hz, 4:2:2
720p @60 / 50Hz, 4:2:2		
SD-SDI	480i @60Hz, 4:2:2	
ITU-R BT.656	576i @50Hz, 4:2:2	

Compatible Audio Format	3G-SDI	48kHz, 16 / 20 / 24 bit, 2 CH, Synchronized Video
	HD-SDI	48kHz, 16 / 20 / 24 bit, 2 CH, Synchronized Video
	SD-SDI	48kHz, 16 / 20 / 24 bit, 2 CH, Synchronized / Asynchronous Video

Max. Transmission Distance 75 ohm coaxial cable	3G-SDI	150m at 2.97Gb/s
	HD-SDI	250m at 1.485Gb/s
	SD-SDI	480m at 270Mb/s

< 3.2 > Options : HDMI video input

MRK-K17 : HDMI 2.0 (HDCP 2.2)

MRK-F17 : HDMI 1.4 (HDCP 1.4)

DP 1.0 (HDCP 1.3)

MRK-X17 : HDMI 1.4 (HDCP 1.4)

MRK-19 : HDMI 1.2 (HDCP 1.1)



(1) In some circumstances, if the user connects the LCD to PC via HDMI port for video and audio signals, the LCD may display incorrectly on a full screen. If so, please adjust the display card setting on display size to fix the issue.

MRK-K17

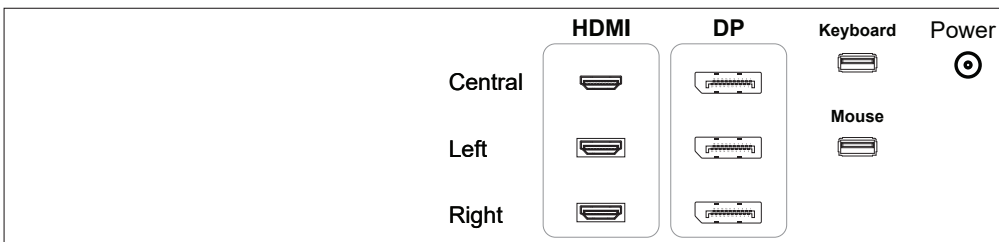

MRK-F17 with Display port

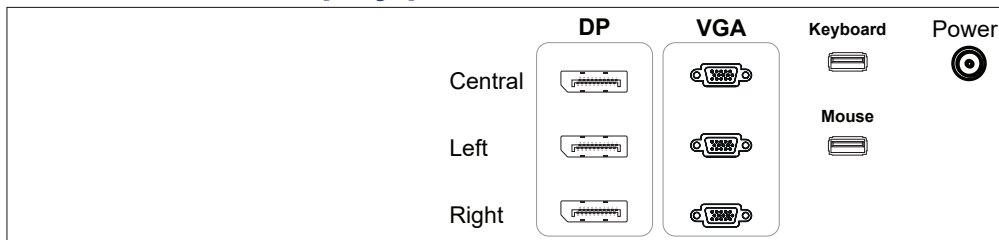

MRK-F17 with HDMI

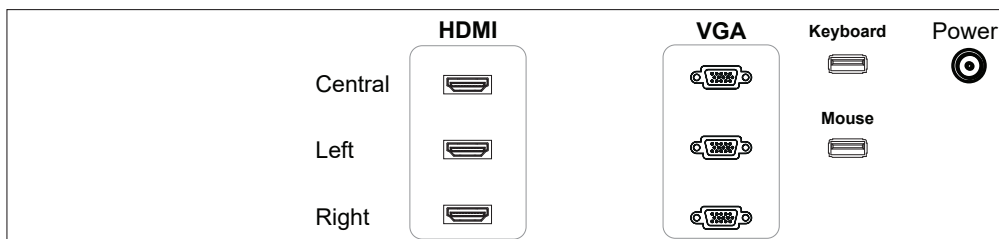

MRK-X17 / MRK-19

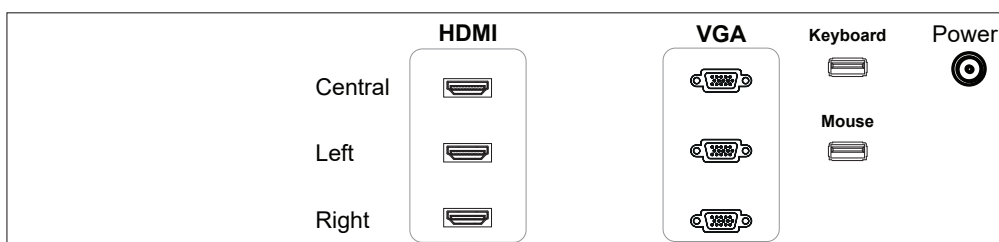

< 3.3 > Options : Touchscreen & driver



Capacitive Touch screen Specification

	MRK-K17	MRK-F17	MRK-X17	MRK-19
Model	TPC-10 Multi-touch			TCB e-Capacitive
Technology	Projected Capacitive			Capacitive
Touch Point	10			Single
Input Type	Finger or Capacitive Stylus			Finger
Resolution	4096 x 4096			2048 x 2048
Touch Point Accuracy	± 2 mm			-
Response Speed	< 5 ms			20 ms
Activation Force	< 5 g			≤ 50 g
Surface Hardness	6H			9H
Light Transmission	> 85%			92% ± 2%
Haze	3% ↓			7%
Durability	50 million touches			300 million touches
Top Layer	1.8 mm Glass			Glass
Bottom Layer	0.7 mm Sensor Glass			
Thickness	2.7 ± 0.1 mm			2.8 mm ± 10%
Connector	USB			USB Type A
Compatibility	Linux / Android / Windows / Mac			

Resistive Touch screen Specification

	MRK-K17	MRK-F17	MRK-X17	MRK-19
Model	TRB e-Resistive			
Technology	5-Wire Resistive			
Touch Point	Single			
Input Type	Finger or Stylus			
Resolution	2048 x 2048			
Response Speed	15 ms			
Activation Force	≤ 50 g			
Surface Hardness	3H			
Light Transmission	80% ± 3%			
Haze	8% ± 3%			
Durability	10 million touches			
Top Layer	ITO Film			
Bottom Layer	ITO Glass			
Thickness	3.2 ± 0.2 mm	2.2 ± 0.2 mm	3.2 ± 0.2 mm	2.2 ± 0.2 mm
Connector	USB Type A			
Compatibility	Windows 7 / XP / Vista, Linux			

- USB touchscreen package includes 1 x 6ft USB cable, quick reference guideline and CD disc
- For detailed information, please refer to the attached CD disc
- As the touchscreen unit is not made of toughened glass, please handle it carefully

TPC-10 Driver



Connect the USB cable from the USB port on the LCD to a computer. The touch screen supports easy Plug-and-Play operations. There is no need to install additional drivers on the computer.

TRB / TCB Driver

Please follow the below steps to setup the touch screen:-

Step 1. Run the bundled CD disc or download the driver from the link below :
<http://www.austin-hughes.com/resources/driver/ultraview>

Step 2. Double click the Setup.exe

Step 3. Follow the installation instruction to finish the setup

Step 4. After installation, run the TouchKit program & the “4 point calibration”



Please do the initial calibration after the first setup

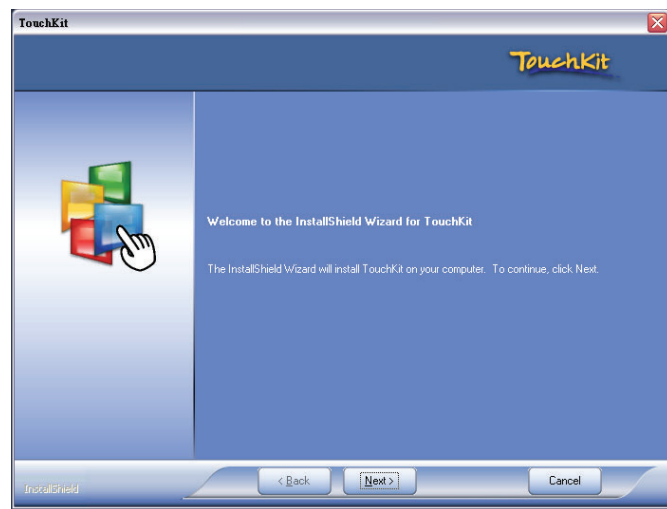

< 3.4 > Options : DC Power

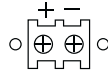

Model	12V	24V	48V	125V
Input rating				
Input voltage:	12-Volt	24-Volt	48-Volt	110-Volt
Input range:	9 ~ 18V	18 ~ 36V	36 ~ 75V	66 ~ 160V
Input current				
- No load	50 mA	50 mA	50 mA	35 mA
- Full load	4950 mA	2450 mA	1220 mA	460 mA
Output rating				
Output voltage:	12-Volt	12-Volt	12-Volt	12-Volt
Output current:	4.16A	4.16A	4.16A	4.16A
Efficiency	84%	88%	90%	89%

MRK-K17

DC power

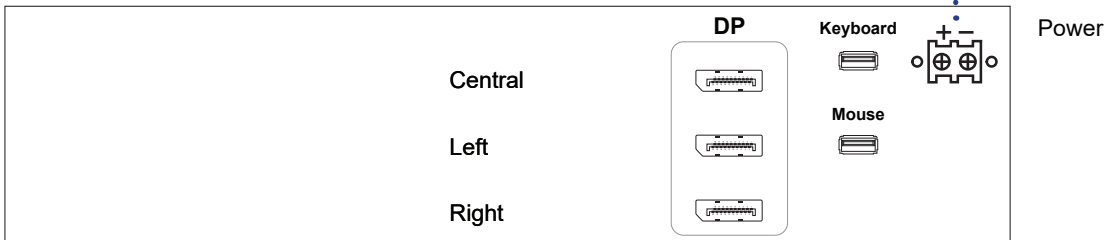

MRK-F17 / MRK-X17 / MRK-19

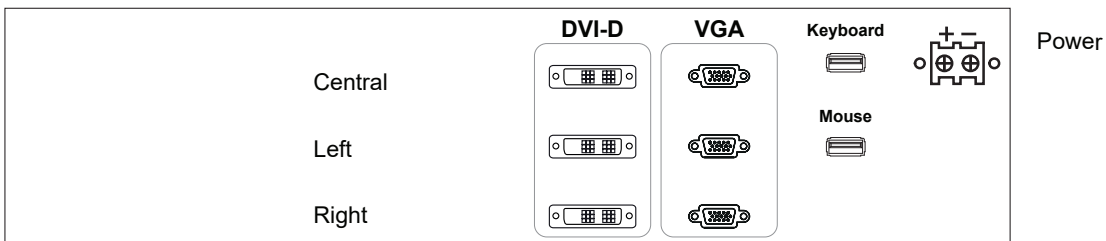

*** For DC power option :

(1) If the unit with LCD, earthing may be required

(2) DC option excludes AC power adapter and power cord.

Intentionally Left Blank

The company reserves the right to modify product specifications without prior notice and assumes no responsibility for any error which may appear in this publication.

All brand names, logo and registered trademarks are properties of their respective owners.

Copyright 2022 Austin Hughes Electronics Ltd. All rights reserved.