

VGA KVM Matrix Switches

CATCenter X2 | 7.2

VGA KVM Matrix Switches

Matrix Switches for the operation and administration of multiple computers across distributed users



Leading the way in digital KVM



Leading the Way in digital KVM

Guntermann & Drunck GmbH has been established in 1985 and is named after its founders. Over 25 years have since past, and we are now a leading manufacturer of digital and analog KVM switching systems.

As an owner-managed company we work with a broad range in both digital and analog KVM closely with the marketplace and make our decisions with and in the interests of our customers. It is our philosophy to meet our customers while making decisions, to accompany them in the process and ensure that they achieve their goals.

We can do this because as a medium sized company we have short communication paths and all core competencies are in house – from development through to production. This way we can even make the impossible possible at times. If it is thanks to the modularity of the products or by implementing a customised solution. We orient ourselves towards the needs of the customer – and not the other way round.

Organisations, service providers and companies of all sizes managing numerous computers, servers and other network devices trust the comprehensive advice and service provided by Guntermann & Drunck GmbH.

Thanks to these different fields of specialisation, the demands placed on the products are many and are manifold. Our products have to provide a long-life service, be secure, uncomplicated, user-friendly, understandable and adaptable.

The System

The KVM matrix switch CATCenter X2 enables the operation of **16 computers** over **2 simultaneous user modules**.

The system can be expanded to up to **1024 computers**.

A **working system** requires at least:

- 1 x central module CATCenter X2
- 1 x computer module CATpro2
- 1 x user module UCON
- 2 x CAT transmission cable (type 5, 6, 7)

By applying the required modules (UCON/CATpro2), the CATCenter X2 can process the following signals:

- keyboard/mouse [USB, PS/2, DEC-PS/2, SUN-USB-DE, SUN-USB-US]
- video [VGA, DVI (at server side)]

The CATCenter X is available as X2 variant only.



Highlights

Video

- switch and extender combined in one system
- automatic image tuning for each line between user module and computer module
- transmission up to 300 m over CAT cable at maximum resolution
- integration of DVI computers via CATpro2-DVI-Audio-UC

Signals

- PS/2 and USB keyboard/mouse

Expansion

- expandable to up to 1024 computers
- expandable with power switching component
- firmware expansion for multi-monitor consoles (TS function)
- firmware expansion to push/get own or remote screen contents (Push-Get function)

Communication/Safety

- access protection and user administration can be switched off
- auto-recognising and showing of system architecture
- redundant power supply

Features

Video

- analog resolution up to 1920 x 1440 @ 75Hz
- colour mode analog 32 Bit
- digital resolution (over IP) max. 1920 x 1200 @ 60Hz according to VESA CVT-RB
- colour mode digital 8 Bit (with UCON-IP-NEO)
- automatic video settings with possibility for individual adjustments
- transmission length between computer module and user module: 300 m via CAT cable

Device

- only accesses the computer's standard interfaces
- no software installations required
- available as desktop and rackmount version
- housed in an aluminium casing for best interference resistance
- redundant power supply
- possibility to hot-plug system components
- server stay-alive-function
- power switches can be integrated into the system (Hardboot CCX)

Application

The CATCenter X2 matrix switch is designed for applications in rarely growing server rooms that can be controlled via two consoles.

Thanks to the various UCON user modules (local, remote, over CAT-x cable, remote over IP), the CATCenter X2 supports any operating preferences.

Differences to CompactCenter X2

- integrated CompactCenter user consoles (1 x local, 1 x IP)

- CompactCenter provides network connection
- CompactCenter configuration over IP/web interface

Differences to the CATCenter NEO series

- NEO includes audio switching
- NEO provides network connection
- NEO configuration over IP/web interface
- NEO not restricted to two consoles

The CATCenter X2 can be used as slave in CATCenter NEO systems.

Application scheme

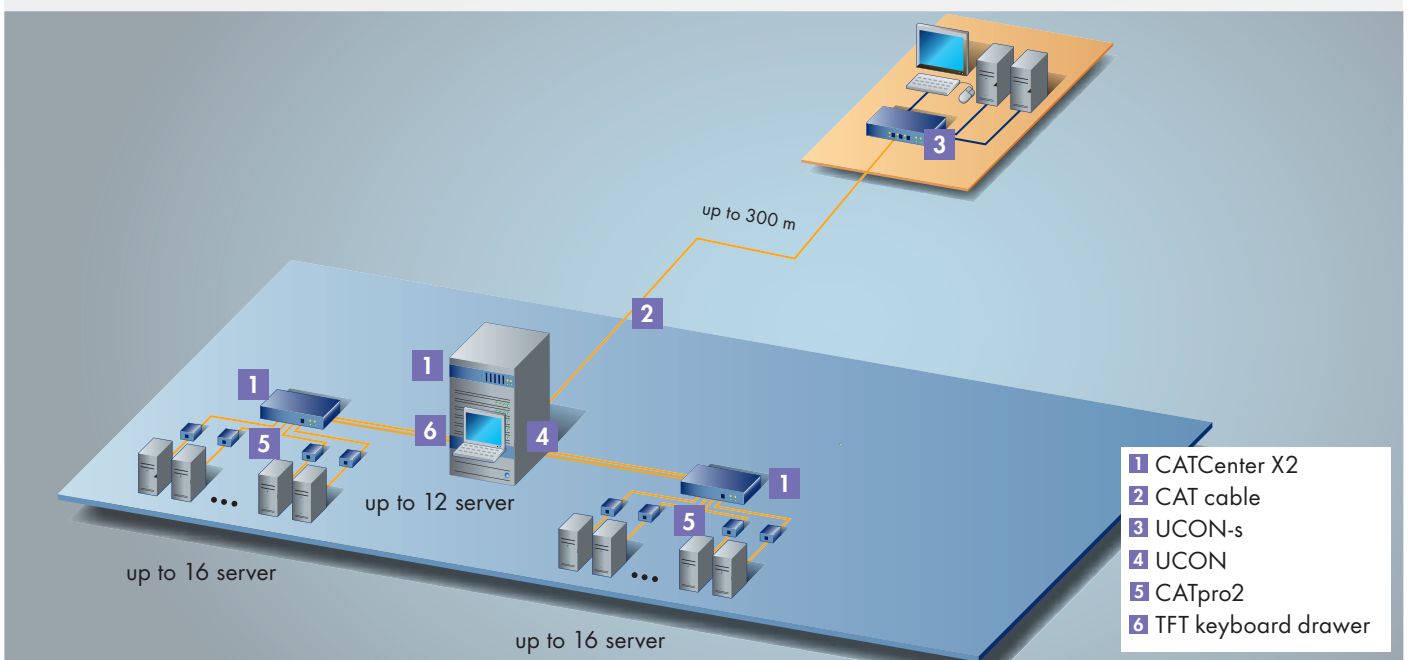

Variants

Design

The CATCenter X2 devices are shipped as desktop variant.

The package contents include a 19" rackmount set.

CATCenter X2



left: CATCenter X2 - front view
right: CATCenter X2 - rear view

CATCenter X2	
User console	
Type of User Ports	permanently assigned
Console ports per device	2
Max. no. of consoles per cluster	2
Transmission type user module	dedicated CAT-x connection
Ports to user module	2 x RJ45 socket
Computer	
Type of computer ports	permanently assigned
Computer ports	16
Computer ports cascade level 1	128
Computer ports cascade level 2	1024
Transmission type to computer module	dedicated CAT-x connection
Interfaces to computer module	16 x RJ45 socket
Main power supply	
Type	internal power pack
Connector	1 x IEC plug
Voltage	AC100-240V/60-50Hz
	130-80mA
Redundant power supply	
Typ	external power pack
Connection	Mini-DIN 4 socket
Voltage	+12VDC
	1.0A
Casing	
Material	anodised aluminium
Desktop (W x H x D)	435 x 44 x 286 mm
Rackmount (W x H x D)	19" x 1U x 286 mm
Weight	approx. 2.5 kg
Update	
Mode	via update wizard at local service socket
Connection	2.5 mm jack plug
Power Switching	
Interface	RJ11 Socket
Operating environment	
Temperature	+5 to +45 °C
Air humidity	< 80% non-condensing
Conformity	CE, RoHs

Computer modules

The CATpro2 computer modules connect the **computer's external keyboard, video, mouse, and audio interfaces** with the matrix switch system.

The CATpro2 modules combine signals, process them, and use **CAT cables to transmit said signals to the KVM matrix switch**.

Each CATpro2 has a **unique ID** helping you locate the device within a matrix switch system.



CATpro2-USB

Legend

extended	120 cm overall length for telescopic rail support
UC	offers connectivity for 2 CATCenter clusters
DVI	integration of DVI-I single-link video on server side
Audio	offers connectivity for unidirectional audio
DE	German SUN keyboard layout
US	American SUN keyboard layout
VT100	converts the VT100 protocol to VGA and PS/2

Computer module | Standard

Standard variant. Transmits the following signals:

- VGA
- Keyboard/mouse PS/2, PS/2-DEC, USB or SUN-USB (DE/US)



CATpro2-PS/2

	Standard
General information	
Signal type/Video	analog video
No. of interfaces to central module	1
Total length incl. cable	0.3 m
Power supply	
Main Type	via computer keyboard interface
Connection	Mini-DIN 6/USB
Voltage	+5VDC
Interfaces to computer	
CATpro2-PS/2	2 x Mini-DIN 6 plug, 1 x D-Sub HD 15 plug
CATpro2-PS/2-DEC	2 x Mini-DIN 6 plug, 1 x D-Sub HD 15 plug
CATpro2-USB	1 x USB-A plug, 1 x D-Sub HD 15 plug
CATpro2-SUN-USB (de)	1 x USB-A plug, 1 x D-Sub HD 15 plug
CATpro2-SUN-USB (us)	1 x USB-A plug, 1 x D-Sub HD 15 plug
Interfaces to central module	
	1 x RJ45 socket
Housing	
Material	plastics
Desktop (W x H x D)	45 x 20.7 x 65 mm
Design	converter
Weight	approx. 120 g
Operating conditions	
Temperature	+5 to +45 °C
Air humidity	< 80% non-condensing
Conformity	CE, RoHs

Computer module | extended

Standard variant with extended connection cable for installing telescopic rails in rack mounted servers (total length of housing and cable = 120 cm). Transmits the following signals:

- VGA
- Keyboard/mouse PS/2, PS/2-DEC, USB or SUN-USB (DE/US)



CATpro2-extended-PS/2

	extended
General information	
Signal type/Video	analog video
No. of interfaces to central module	1
Total length incl. cable	1.2 m
Power supply	
Main Type	via computer keyboard interface
Connection	Mini-DIN 6 / USB
Voltage	+5VDC
Interfaaces to computer	
CATpro2-extended-PS/2	2 x Mini-DIN 6 plug, 1 x D-Sub HD 15 plug
CATpro2-extended-PS/2-DEC	2 x Mini-DIN 6 plug, 1 x D-Sub HD 15 plug
CATpro2-extended-USB	1 x USB-A plug, 1 x D-Sub HD 15 plug
CATpro2-extended-SUN-USB (de)	1 x USB-A plug, 1 x D-Sub HD 15 plug
CATpro2-extended-SUN-USB (us)	1 x USB-A plug, 1 x D-Sub HD 15 plug
Interfaces to central module	
	1 x RJ45 socket
Housing	
Material	plastics
Desktop (W x H x D)	45 x 20.7 x 70 mm
Design	converter
Weight	approx. 120 g
Operating conditions	
Temperature	+5 to +45 °C
Air humidity	< 80% non condensing
Conformity	CE, RoHs

Computer module | DVI-A

Standard variant with audio support. Transmits the following signals:

- DVI-A
- Keyboard/mouse PS/2, USB



CATpro2-DVIA-PS/2

	Audio
General information	
Signal type/Video	analog video
No. of interfaces to central module	1
Total length incl. cable	0.3 m
Power supply	
Main Type	via computer keyboard interface
Connection	Mini-DIN 6 / USB
Voltage	+5VDC
Interfaces to computer	
CATpro2-Audio-PS/2	2 x Mini-DIN 6 plug, 1 x DVI-A plug
CATpro2-Audio-USB	1 x USB-A plug, 1 x DVI-A plug
Interfaces to central module	
	1 x RJ45 socket
Housing	
Material	plastics
Desktop (W x H x D)	65 x 20.7 x 65 mm
Design	converter
Weight	approx. 130 g
Operating conditions	
Temperature	+5 to +45 °C
Air humidity	< 80% non-condensing
Conformity	CE, RoHS

Computer module | DVI-Audio-UC

Variant for connecting computers with DVI single-link video at resolutions up to 1920 x 1200 @ 60 Hz. Converts DVI to VGA. Designed as dual module with audio support for the connection to two matrix switch clusters. Transmits the following signals:

- DVI single link
- Keyboard/mouse USB or SUN-USB (DE/US)
- Audio (Line Out)

Audio is exclusively supported by CATCenter NEO.



CATpro2-DVI-Audio-UC-USB

DVI-Audio-UC	
General information	
Signal type/Video	digital video (DVI-D)
Resolution	1920 x 1200 @ 60 Hz
No. of interfaces to central module	2
Total length incl. cable	2.0 m
Power supply	
Main Type	via USB interfaces of computer module/external power pack
Connection	USB Mini-DIN 4 Buchse
Voltage	+ 5VDC +12VDC
Interfaces to computer	
CATpro2-DVI-Audio-UC-USB	2 x USB-B socket, 1 x DVI-D socket, 1 x 3,5 mm jack plug
CATpro2-DVI-Audio-UC-SUN USB (de)	2 x USB-B socket, 1 x DVI-D socket, 1 x 3,5 mm jack plug
CATpro2-DVI-Audio-UC-SUN USB (us)	2 x USB-B socket, 1 x DVI-D socket, 1 x 3,5 mm jack plug
Interfaces to central module	
	2 x RJ45 socket
Housing	
Material	anodised aluminium
Desktop (W x H x D)	105 x 26 x 84 mm
Design	converter
Weight	approx. 200 g
Operating conditions	
Temperature	+5 to +45 °C
Air humidity	< 80% non-condensing
Conformity	CE, RoHs

Computer module | VT100

Variant for connecting serial servers or other components (e.g. network devices) without graphical interface via serial interface. Converts VT100 protocol to VGA and PS/2. The CATpro2-VT100 can be configured and operated over graphical user interface.

Features

- displays resolutions of 800 × 600 or 1024 × 768
- configuration over GUI
- copy/paste via mouse within the terminal window
- supports various keyboard layouts
- visible bell (visual message)
- switches between DCE and DTE
- interface generates no break signals (break-free)
- supports current features of higher VT protocols
- upgradeable (e.g. reloadable character sets)



CATpro2-VT100

	VT100
General information	
Signal type/protocol	serial, VT100
No. of interfaces to central module	1
Total length incl. cable	2.0 m
Transmission rate RS232	max. 115200 bps
Updates	1 × 2.5 mm jack plug
Power supply	
Main Type	external power pack
Connection	Mini-DIN socket
Voltage	+12VDC
Interfaces to computer	
CATpro2-VT100	1 × D-Sub 9 socket
Interfaces to central module	
	1 × RJ45 socket
Housing	
Material	anodised aluminium
Desktop (W × H × D)	105 × 26 × 84 mm
Design	converter
Weight	approx. 200 g
Operating conditions	
Temperature	+5 to +45 °C
Air humidity	< 80% non-condensing
Conformity	CE, RoHs

User modules

Use the UCON user modules to connect monitor, keyboard and mouse to the CATCenter systems.

CAT cables connect the UCONs to the CATCenters. The UCONs also provide the required ports for peripherals.

The UCON user modules are available in variants for direct (= 1:1 via CAT cable) or digital (= over IP) access.



UCON - front view

UCON (direct access)

UCONs provide the following features:

- dedicated 1:1 connection
- large video bandwidth
- high performance (1:1)
- no latencies

If the console to be installed is attached to a certain place and placed within a maximum distance of 300 metres away from the farthest computer, we recommend deploying direct access UCONs.

We provide the following UCON variants:

- UCON
- UCON-Audio
- UCON-s
- UCON-Audio-s

Digital UCON (access over IP)

If you need to access your computers from anywhere, we recommend deploying digital UCONs.

Digital UCONs provide the following features:

- servers can be accessed over network
- within the existing infrastructure (in-band)
- no additional software at console
- no soft- or hardware installations at target server
- no configuration at target server, e.g. mouse settings
- comprehensive password protection

We provide the following digital UCON variants:

- UCON-IP-NEO
- Twin-UCON-IP-NEO

Are you interested in experiencing the performance of our KVM-over-IP solutions? Then please [request your access data here](#).

IP-Access trial

User module | UCON

Application

- UCON for direct access
- console up to 300 metres away from the computer module

Signals

- VGA Video
- Keyboard/Mouse PS/2 + USB

Operation

- select computers via OSD or hotkeys
- configuration via OSD (and web interface at CATCenter NEO)
- supports both TS and Push-Get function (see expansions)



UCON - rear view

Design

- desktop or rack mount variant
- also available as TWIN variant (two devices in one housing on 1U)

	UCON
User module	
Consoles	1
Additional ports for console computers	no
Interfaces for console computers (with CATpro2 variant)	--
Assigned console ports at central module	1
Interfaces to central module	RJ45 socket
Transmission	
Transmission type	dedicated CAT-x link
Transmission cable type	CAT-x cable
Transmission distance	300 m
Video	
Signal type/Video	VGA Video
resolution (depending on cable), local connection	1920 x 1440 @ 75Hz
Delay compensation	yes
Interfaces for console	
Video	D-Sub HD 15 socket
Keyboard/Mouse	2 x Mini-DIN 6 socket
	2 x USB-A socket
TradeSwitch-LED	D-Sub 9 socket
Main power supply	
Type	internal power pack
Connector	1 x IEC plug
Voltage	AC100-240V/60-50Hz / 0.2-0.1A
Redundant power supply	
Type	external power pack
Connector	Mini-DIN 4 socket
Voltage	+12VDC/0.8A

Housing	
Material	anodised aluminium
Desktop (WxHxD)	270 x 44 x 211 mm
Rackmount (BxHxT)	19" x 1HE x 211 mm
Weight	approx. 1.3 kg
Update	
Process	via update wizard at local service socket
Connector	2.5 mm jack plug
Operating conditions	
Temperature	+5 to +45 °C
Air humidity	< 80% non-condensing
Conformity	CE, RoHS

User module | UCON-s

Application

- UCON for direct access
- console up to 300 m away from the computer module
- additional connection of two console computers

Signals

- VGA Video
- Keyboard/Mouse PS/2 + USB

Operation

- select computers via OSD or hotkeys
- select console computers or remote computers via button at the front



UCON-s - rear view

- configuration via OSD (and web interface with CATCenter NEO)
- supports Push-Get function (see expansions)

Design

- desktop or rackmount variant

	UCON-s
User module	
Consoles	1
Additional ports for console computers	yes, 2
Interfaces for console computers (with CATpro2 variant)	RJ45 socket
Distance console computers - UCON-s	max. 5 m
Assigned console ports at central module	1
Interfaces to central module	RJ45 socket
Transmission	
Transmission type	dedicated CAT-x link
Transmission cable type	CAT-x cable
Transmission distance	300 m
Video	
Signal type/Video	VGA Video
resolution (depending on cable), local connection	1920 x 1440 @ 75Hz
Delay compensation	yes
Interfaces for console	
Video	D-Sub HD 15 socket
Keyboard/Mouse	2 x Mini-DIN 6 socket
	2 x USB-A socket
TradeSwitch-LED	D-Sub 9 socket
Main power supply	
Type	internal power pack
Connector	1 x IEC plug
Voltage	AC100-240V/60-50Hz / 0.2-0.1A
Redundant power supply	
Type	external power pack
Connector	Mini-DIN 4 socket
Voltage	+12VDC/0.8A

Housing	
Material	anodised aluminium
Desktop (WxHxD)	270 x 44 x 211 mm
Rackmount (BxHxT)	19" x 1HE x 211 mm
Weight	approx. 1.3 kg
Update	
Process	via update wizard at local service socket
Connector	2.5 mm jack plug
Operating conditions	
Temperature	+5 to +45 °C
Air humidity	< 80% non-condensing
Conformity	CE, RoHS

User module | UCON-IP-NEO

Application

- digital UCON for IP access
- IP console, which accesses the system over network (unlimited distance)
- competing local console at device for access at server room

Signals

- VGA Video
- colour mode 8 Bit
- resolution via IP up to 1920 x 1200 @ 60Hz
- resolution locally up to 1920 x 1440 @ 75Hz
- Keyboard/Mouse PS/2

Operation

- IP session over native client for Windows or Linux
- or Java client (called up via web interface of UCON-IP-NEO)



TWIN-UCON-IP-NEO- rear view

- select computers via OSD or graphical interface
- configuration over web interface of the device
- supports Push-Get function (see expansions)

Design

- also available as twin variant (two devices in one housing on 1U)
- desktop version incl. rackmount kit

	UCON-IP-NEO
User module	
Consoles	2 (1 x IP, 1 x local, competing)
Additional ports for console computers	no
Interfaces for console computers (with CATpro2 variant)	- -
Assigned console ports at central module	1
Interfaces to central module	RJ45 socket
Network interface	RJ45 socket
Transmission	
Type to central module	dedicated CAT-x link
Cable type	CAT-x cable
Distance	300 m
Type to KVM-IP client	TCP/IP protocol
Communication Ethernet	10/100/1000 Mbit/s
Distance IP	unlimited
Video	
Signal type/Video	VGA video
resolution (depending on cable), local connection	1920 x 1440 @ 75Hz
Resolution via IP up to	1920 x 1200 @ 60Hz
Delay compensation	yes
Interfaces for console	
Video	D-Sub HD 15 socket
Keyboard/Mouse	2 x Mini-DIN 6 socket
Main power supply	
Type	internal power pack
Connector	1 x IEC plug
Voltage	AC100-240V/60-50Hz / 0.3-0.2A

Redundant power supply	
Type	external power pack
Connector	Mini-DIN 4 socket
Voltage	+12VDC/1.2A
Housing	
Material	anodised aluminium
Desktop (WxHxD)	435 x 44 x 356 mm
Rackmount (BxHxT)	19" x 1HE x 356 mm
Weight	approx. 3.0 kg
Update	
Process	via web interface
Connector	RJ45 socket
Operating conditions	
Temperature	+5 to +40 °C
Air humidity	< 80% non-condensing
Conformity	CE, RoHs

Operation / Configuration

The CATCenter X system is operated/configured via:

- OSD + hotkeys
- KVM-IP client (only for UCON-IP-NEO)
- UCON-IP web interface (only for UCON-IP-NEO)

OSD and hotkeys are available on all UCON user modules and ensure fast, clearly arranged and easy operation across the entire system.

OSD

The OSD as the central component for operating and configuring the system is available at all external or internal UCON user consoles.

It can be adapted to the user's needs and the security policies of its environment.

The OSD can be easily accessed via keyboard/mouse and configurable hotkeys while key combinations open the OSD menus.

The following main menus are available:

Select

- select any computer
- search any computer

Operation (frequent operating processes)

- scan channels
- logout
- disconnect
- switch power

Personal Profile (user-related settings)

- define preferred computer
- OSD position/size
- channel display on/off

Configuration (change system settings)

- user administration
- user group management
- access rights management

Information (query system status)

Several operating options:

- user-related OSD
- targets can be directly accessed from the Select menu
- configurable hotkeys allow quick access to targets
- AutoScan, AutoSkip, StepScan

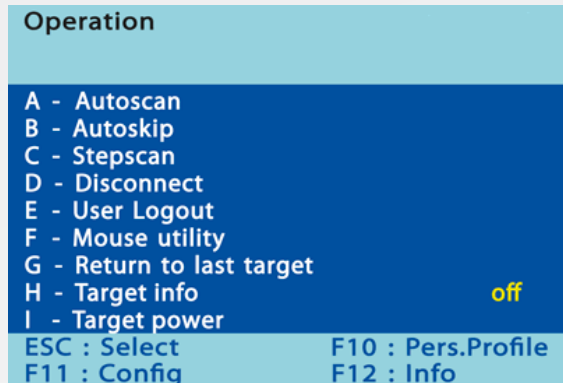
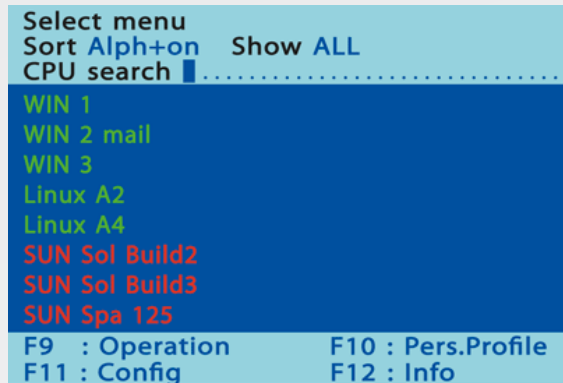

KVM-IP-Client

KVM IP clients enable the user fast and stable remote access to the servers connected to the matrix switches. The connection is either established using the external UCON-IP-NEO user console or the integrated KVM IP port of the CompactCenter.

In order to establish an IP session, a native client (Windows, GNU/Linux) is installed on a client computer or the JAVA client is activated in the web interface of the devices.

The scope of delivery of both UCON-IP-NEO or Compact-Center already provides one native client, which can be installed or copied as often as necessary. The Java client does not require any software installation on the client computer or the target computer.

After the program has been started and the successful authentication, the desktop of the remote target computer is displayed in a program window on the client computer. The target computers does neither require any hard- or software installations nor any special configurations (e.g. mouse settings).

KVM-IP clients provide the following features:

Operation

- native or Java client
- select computers via GUI or OSD
- operate target computer with original cursor and key board down to BIOS level
- execute comprehensive keyboard macros on target computers (e.g. Ctrl+ Alt+Del)
- transfer content of IP client computer's clipboard to target computer

Video

- automatic determination of video profiles for best performance and image replication
- manual adjustment of video profiles
- activate full-screen mode
- automatic adjustment of client window to target resolution
- make screenshots of active session

Communication

- chat with another client

System settings

- measure the bandwidth of the data transmission
- configure a mouse break
- enable mouse gestures to operate the IP client

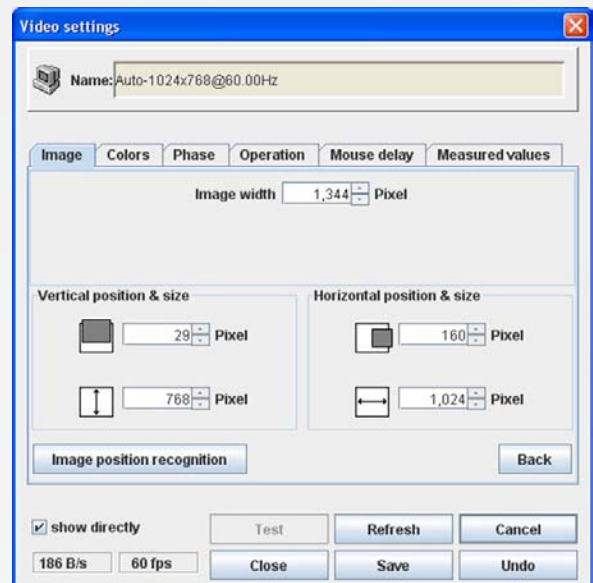
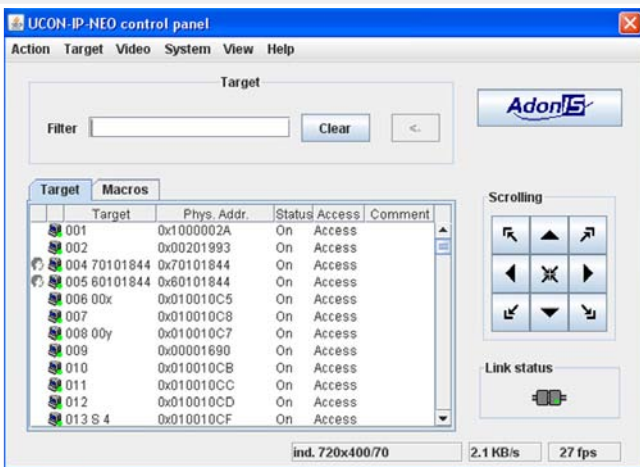

UCON-IP Web-Interface

The web interface is used to configure the UCON-IP-NEO user console and provides the following selected settings:

Configuration

- set network parameters
- enable session time-out for IP clients
- set system date and time, select NTP server

Maintenance

- backup configuration data
- restore configuration data
- reset system defaults

Logging

- adjust syslog settings
- query system information, e.g. current network settings, log files, system configuration, active IP sessions, local syslog protocol
- forward syslog messages to two different servers

Update

- install firmware updates via network

Java client for access over IP

- activate Java client to access the computers connected to the CATCenter over IP

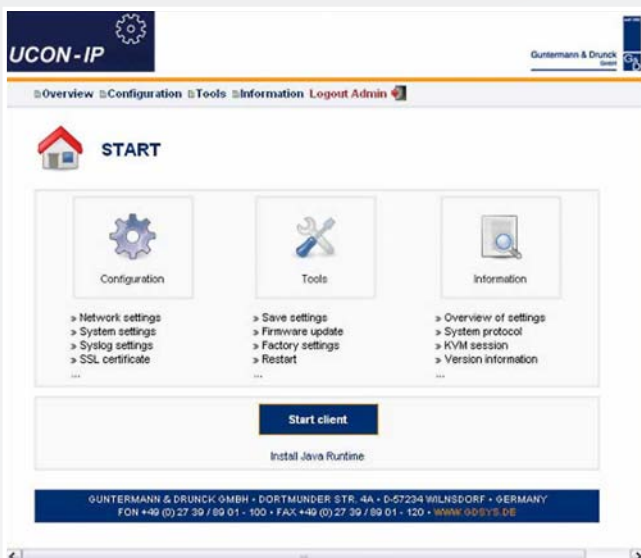

Hardware / Expansions

Any hardware components are connected to the CATCenter X2 and thus fully integrated into operation. Now, e.g. power-switching can be carried out in the OSD.

We provide the following hardware expansions:

- remote power-switching with HardBoot CCX
- increasing the number of computers by cascading with other CATCenter X2 switches

Power Switch

The HardBoot CCX is especially designed for the use with G&D matrix switches. The device switches up to 128 users per matrix switch.

The remote power switch supplies eight AC outlets per device. The outlets are divided into two different power circuits with four outputs each. Up to 16 HardBoot power switches can be integrated into one power cluster (= 128 outputs).

The 128 outputs can be grouped individually so that redundant power packs are supported as well (up to 3 AC outputs per CATCenter CPU port).

A serial connection links the HardBoot CCX to the CATCenter. The power switch is operated via CATCenter OSD.

For more information on the HardBoot, please see Power Switches.



HardBoot

More computers

By cascading, the CATCenter X system can provide more possibilities to connect servers.

Any CATCenter central modules can be interconnected. When cascading different types of CATCenters, the most powerful device should be the master device within the cascade since the master carries out all controlling tasks.

If the CATCenter NEO is used as master, the whole cascade can be configured via network. The CATCenter NEO can also serve as master for any CATCenter X variant.

	CATCenter X2	
	No. of Target Ports	CATCenters in total
Target-Ports native	16	1
Cascade level 1	128	9
Cascade level 2	1024	73

Firmware / Expansions

The firmware expansions are activated in the OSD using an activation key.

We provide the following firmware expansions:

TS function

- (use multiple UCONs to create a multi-monitor console and operate it over one keyboard/mouse)

Push/Get function

- (move the image - or image and operation - of your console to another UCON or get the image from there)

TS-Funktion

Function: UCON pooling

Operation: via hotkeys

Operating requirement: activation within master

Efficiency: 1 cluster

The TradeSwitch function combines the 2 user modules (UCON) to one logical console. This logical console can be operated using only one keyboard/mouse but provides several monitors (multi-monitor console). Even large-screen projections can be integrated.

Via hotkey, keyboard and mouse focus can be assigned to one any UCON of the logical console. Ten hotkeys that can be individually defined are available.

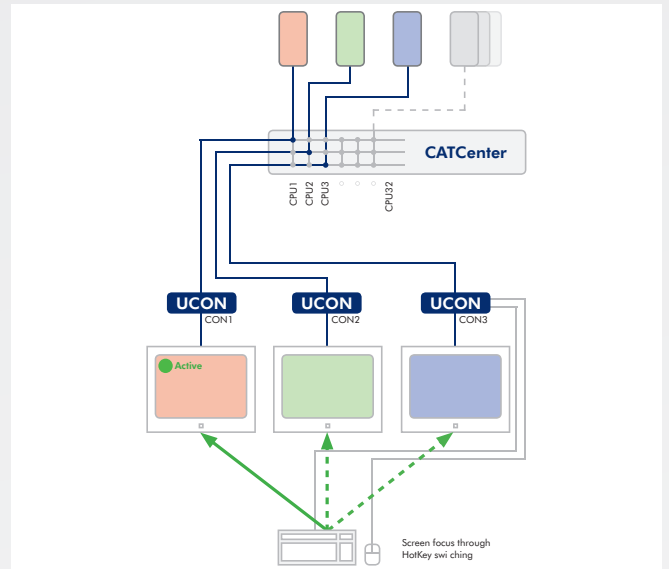

Push-Get

Function: interaction between UCONs

Operation: via OSD

Application requirement: Activation through master

Availability: within one cluster

The Push-Get function allows you to push the screen content of a target from one screen to another – or to get it from there. This console can also be a large screen projection.

This way, two operators can exchange and share screen contents and therefore tasks.

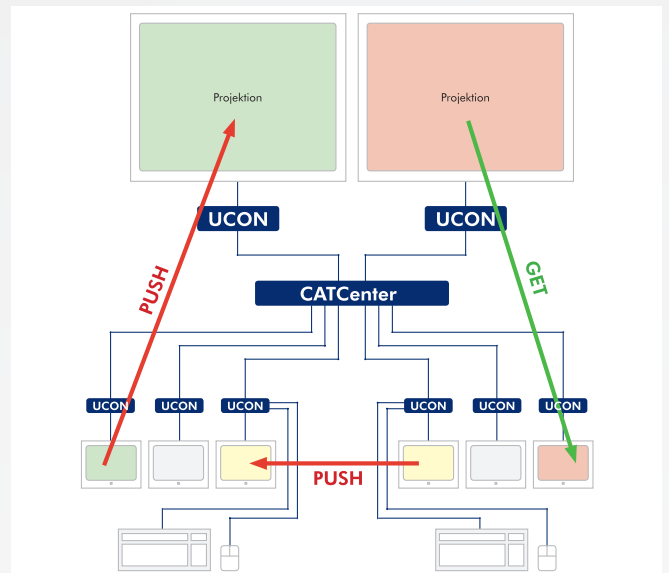

List of Item Numbers Central Modules

Item no.	Description	User modules	Computer
A2300023	CATCenter X2	2	16

List of Item Numbers Computer Modules

Item no.	Description	PS/2	USB	VGA	DVI	Audio	Length of connection cable	Number of clusters
CATpro2 (Standard)								
A2320009	CATpro2-PS/2	PS/2		VGA			0,3 m	1
A2320029	CATpro2-PS/2-DEC	PS/2		VGA			0,3 m	1
A2320010	CATpro2-USB		USB	VGA			0,3 m	1
A2320011	CATpro2-SUN USB-DE		USB	VGA			0,3 m	1
A2320012	CATpro2-SUN USB-US		USB	VGA			0,3 m	1
CATpro2-extended								
A2320017	CATpro2-extended PS/2	PS/2		VGA			1,2 m	1
A2320031	CATpro2-extended PS/2-DEC	PS/2		VGA			1,2 m	1
A2320018	CATpro2-extended USB		USB	VGA			1,2 m	1
A2320019	CATpro2-extended SUN-USB-DE		USB	VGA			1,2 m	1
A2320020	CATpro2-extended SUN-USB-US		USB	VGA			1,2 m	1
CATpro2-DVIA								
A2320076	CATpro2-DVIA-PS/2	PS/2			DVIA		0,3 m	1
A2320077	CATpro2-DVIA-USB		USB		DVIA		0,3 m	1
CATpro2-VT100								
A2320021	CATpro2-VT100	PS/2		VGA			2,0 m	1
CATpro2-DVI-Audio-UC								
A2320047	CATpro2-DVI-Audio-UC-USB		USB		DVI	A	2,0 m	2
A2320048	CATpro2-DVI-Audio-UC-SunUSB-DE		USB		DVI	A	2,0 m	2
A2320049	CATpro2-DVI-Audio-UC-SunUSB-US		USB		DVI	A	2,0 m	2

List of Item Numbers User Modules

Item no.	Description	Rackmount / Desktop		VGA	Keyboard/ Mouse	Audio	console computer connectivity	
A1120031	UCON		DT	VGA	PS/2 USB		0	
A1120032	UCON-RM	RM		VGA	PS/2 USB		0	
A1120150	TWIN-UCON	RM	DT	VGA	PS/2 USB		0	
A1120033	UCON-s		DT	VGA	PS/2 USB		2	
A1120034	UCON-s-RM	RM		VGA	PS/2 USB		2	
A1000012	UCON-IP-NEO	RM	DT	VGA	PS/2		0	
A1000013	Twin-UCON-IP-NEO	RM	DT	VGA	PS/2		0	
A8000016	IP-Console Client-WIN	Native client for Windows OS						
A8000017	IP-Console Client-Linux	Native client for Linux OS						

List of Item Numbers Expansions CATCenter X2

























Item no.	Identifier	Description
power switching		
A4100001	HardBootCCX	Power Switch , Rackmount
firmware expansions		
A8200003	TS-Function CCX	TradeSwitch module
A8200004	Push-Get-Function CCX	Push-Get module

Legend

ABBREVIATIONS

CPU	=	Computer module	M	=	Multimode
PC	=	Computer module	S	=	Singlemode
CON	=	User module	RM	=	For assembly in a 19" rack
REM	=	User module	DT	=	Available as desktop variant
MC2	=	Multichannel 2	A	=	Audio
MC3	=	Multichannel 3	AR	=	Audio + RS232
MC4	=	Multichannel 4	R	=	RS232
			U	=	transparent USB 1.1
			U2	=	transparent USB 2.0
			D	=	Delay

EQUIPMENT FEATURES

	=	keyboard/mouse		=	VT100
	=	dual-link DVI video		=	KVM IP access
	=	single-link DVI video		=	Network connection
	=	single-link DVI + VGA		=	Web interface
	=	VGA video		=	DevCon support
	=	Audio		=	Monitoring
	=	RS232		=	CAT cable
	=	USB 1.1		=	Fiber optics
	=	USB 2.0		=	Single user
	=	Delay		=	Multi user
	=	Screen Freeze		=	Separat local/remote user
	=	Power Switching			
	=	Fire Wire			