

## User Manual



**RK-2e / RK-2b**

**1U Short Depth Keyboard Drawer**

FC CE  REACH

Designed and manufactured by Austin Hughes

751

## Legal Information

First English printing, October 2002

Information in this document has been carefully checked for accuracy; however, no guarantee is given to the correctness of the contents. The information in this document is subject to change without notice. We are not liable for any injury or loss that results from the use of this equipment.

## Safety Instructions

**Please read all of these instructions carefully before you use the device. Save this manual for future reference.**

- Unplug equipment before cleaning. Don't use liquid or spray detergent; use a moist cloth.
- Keep equipment away from excessive humidity and heat. Preferably, keep it in an air-conditioned environment with temperatures not exceeding 40° Celsius (104° Fahrenheit).
- When installing, place the equipment on a sturdy, level surface to prevent it from accidentally falling and causing damage to other equipment or injury to persons nearby.
- When the equipment is in an open position, do not cover, block or in any way obstruct the gap between it and the power supply. Proper air convection is necessary to keep it from overheating.
- Arrange the equipment's power cord in such a way that others won't trip or fall over it.
- If you are using a power cord that didn't ship with the equipment, ensure that it is rated for the voltage and current labeled on the equipment's electrical ratings label. The voltage rating on the cord should be higher than the one listed on the equipment's ratings label.
- Observe all precautions and warnings attached to the equipment.
- If you don't intend on using the equipment for a long time, disconnect it from the power outlet to prevent being damaged by transient over-voltage.
- Keep all liquids away from the equipment to minimize the risk of accidental spillage. Liquid spilled on to the power supply or on other hardware may cause damage, fire or electrical shock.
- Only qualified service personnel should open the chassis. Opening it yourself could damage the equipment and invalidate its warranty.
- If any part of the equipment becomes damaged or stops functioning, have it checked by qualified service personnel.

## What the warranty does not cover

- Any product, on which the serial number has been defaced, modified or removed.
- Damage, deterioration or malfunction resulting from:
  - Accident, misuse, neglect, fire, water, lightning, or other acts of nature, unauthorized product modification, or failure to follow instructions supplied with the product.
  - Repair or attempted repair by anyone not authorized by us.
  - Any damage of the product due to shipment.
  - Removal or installation of the product.
  - Causes external to the product, such as electric power fluctuation or failure.
  - Use of supplies or parts not meeting our specifications.
  - Normal wear and tear.
  - Any other causes which does not relate to a product defect.
- Removal, installation, and set-up service charges.

## Regulatory Notices Federal Communications Commission (FCC)

This equipment has been tested and found to comply with the limits for a Class B digital device, pursuant to Part 15 of the FCC rules. These limits are designed to provide reasonable protection against harmful interference in a residential installation.

Any changes or modifications made to this equipment may void the user's authority to operate this equipment. This equipment generates, uses, and can radiate radio frequency energy and, if not installed and used in accordance with the instructions, may cause harmful interference to radio communications.

However, there is no guarantee that interference will not occur in a particular installation. If this equipment does cause harmful interference to radio or television reception, which can be determined by turning the equipment off and on, the user is encouraged to try to correct the interference by one or more of the following measures:

- Re-position or relocate the receiving antenna.
- Increase the separation between the equipment and receiver.
- Connect the equipment into an outlet on a circuit different from that to which the receiver is connected.

# Contents

## < Part. 1 > RK-2e / RK-2b

1.1	Package Content	P.1
1.2	Structure Diagram & Dimension	P.1 - 2
1.3	Installation	P.3
1.4	Connection	P.4

## < Part. 2 > Specifications

2.1	Keyboard / Mouse Specifications	P.5 - 7
2.2	Environmental Conditions	P.8

## Before Installation

- It is very important to mount the equipment in a suitable cabinet or on a stable surface.
- Make sure the place has a good ventilation, is out of direct sunlight, away from sources of excessive dust, dirt, heat, water, moisture and vibration.

## Unpacking

The equipment comes with the standard parts shown in package content. Check and make sure they are included and in good condition. If anything is missing, or damaged, contact the supplier immediately.

### < Part 1 >

#### < 1.1 > Package Content



#### **RK-2e or RK-2b unit X 1**

- EKC-3 6ft Combo keyboard mouse cable X 1
- Pair of L-bracket with fastener screws X 1

#### < 1.2 > Structure Diagram

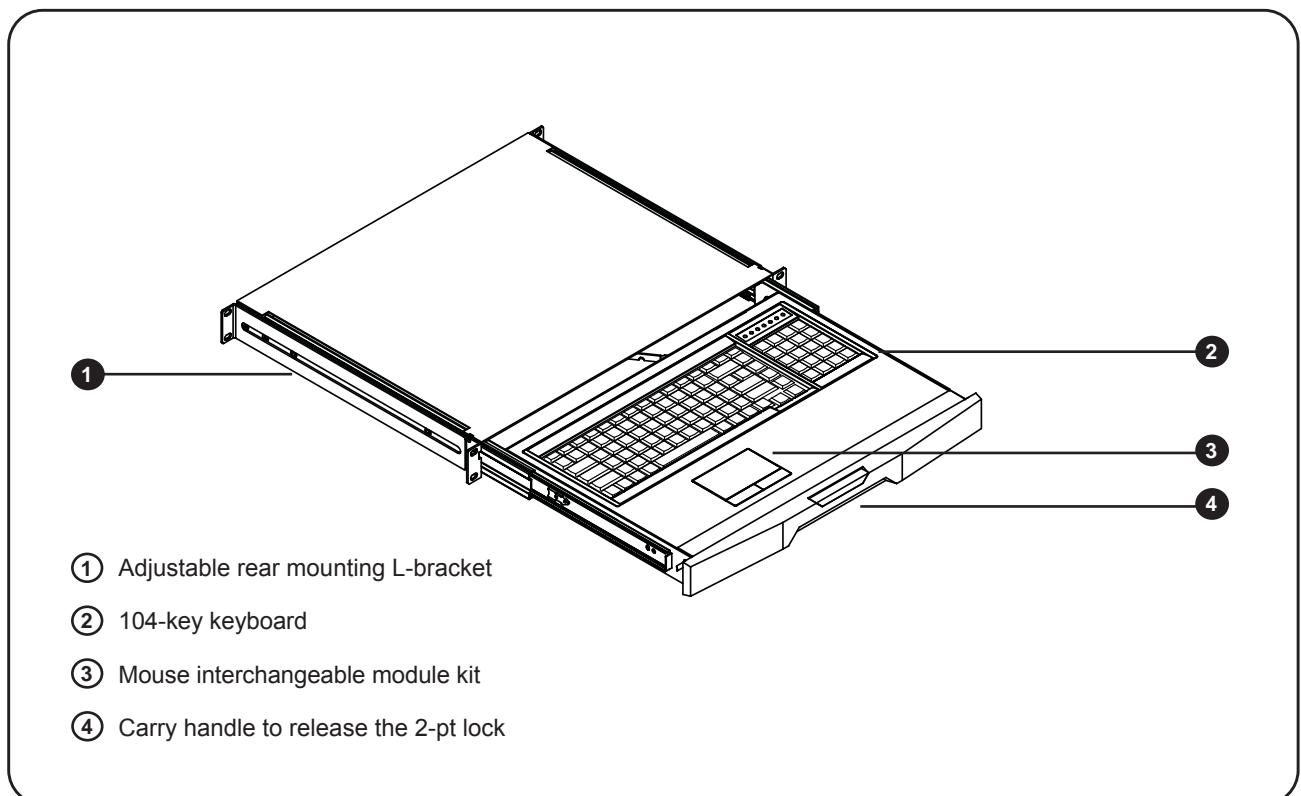

< 1.2 > Dimension

RK-2e / b

Front View

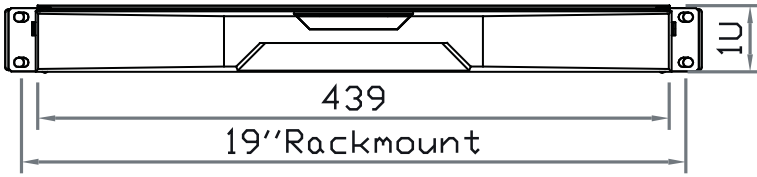

Side View

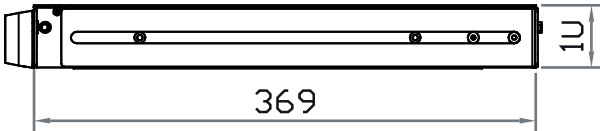

UNIT : mm  
1mm = 0.03937 inch

Top View

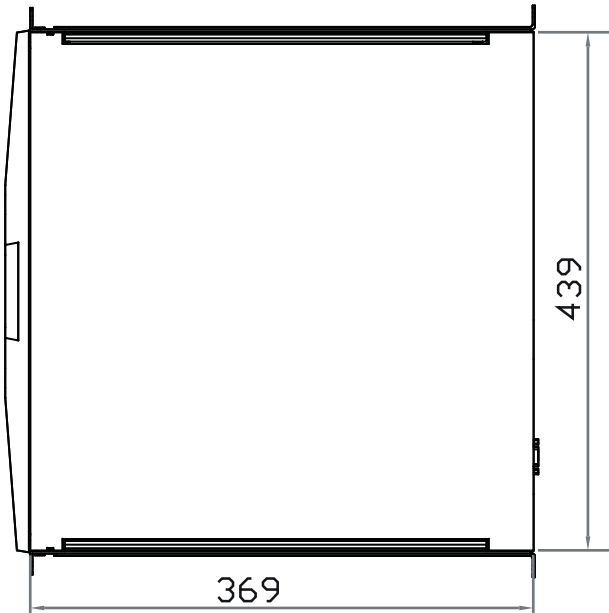

Model	Product Dimension (W x D x H)	Packing Dimension (W x D x H)	Net Weight	Gross Weight
RK-2e / RK-2b	439 x 369 x 44 mm 17.3 x 14.5 x 1.73"	582 x 500 x 100 mm 22.9 x 19.7 x 3.9"	7.4 kg 16.3 lb	9.5 kg 20.9 lb

## < 1.3 > Installation- How to install L-bracket

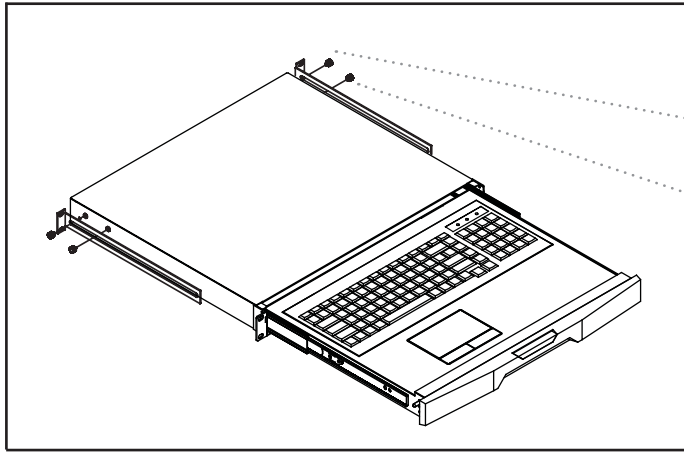

### Step 1

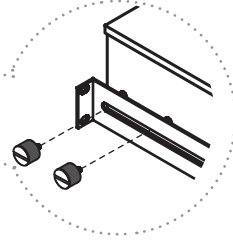

- Install left & right rear L-brackets with two fasteners shown above.
- Leave the fasteners slightly loose.

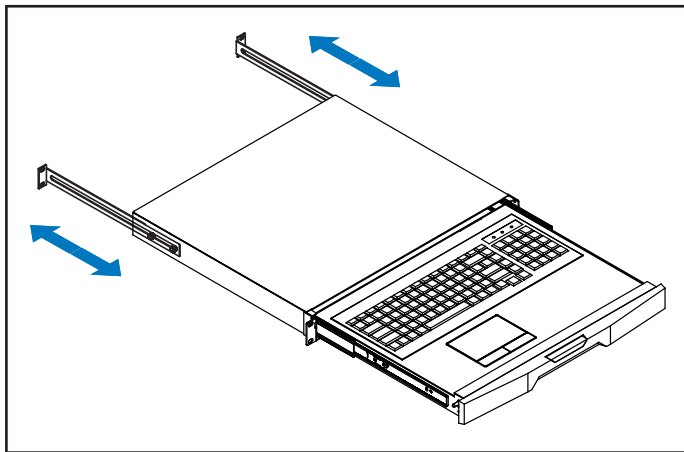

### Step 2

- Measure the depth of the front and rear mounting rails.
- Align each rear L-bracket to a suitable length and tighten the fasteners.

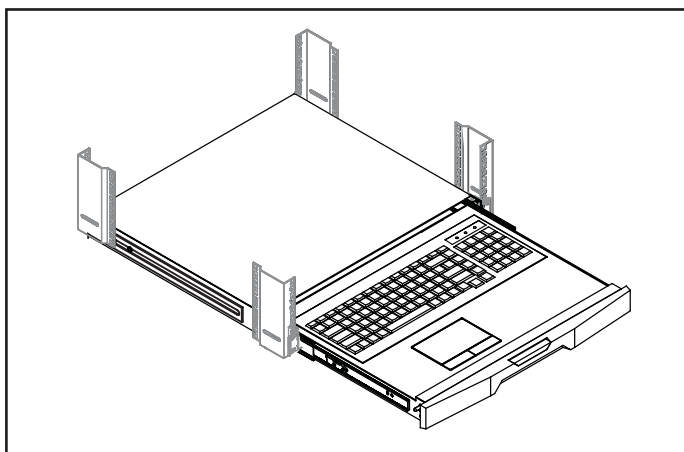

### Step 3

- Fix the keyboard drawer into the rack.
- ⚠ M6 mounting screws & cage nuts are not provided.**

## < 1.4 > Connection to PS/2 or USB Server

RK-2e / b

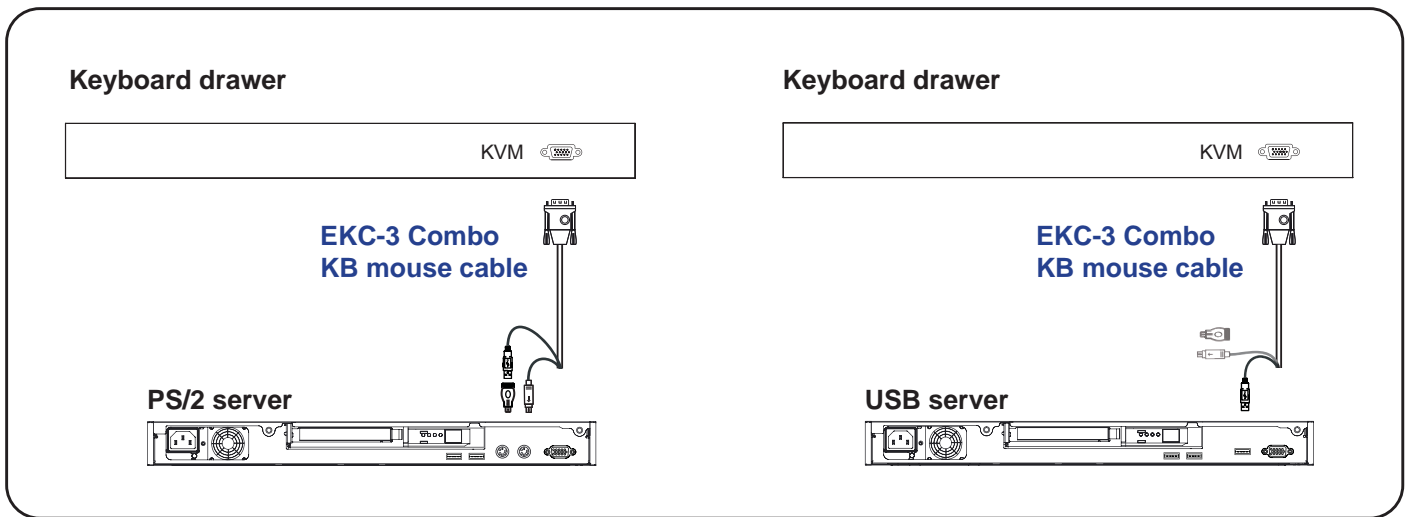

## < 1.4 > Connection to external KVM

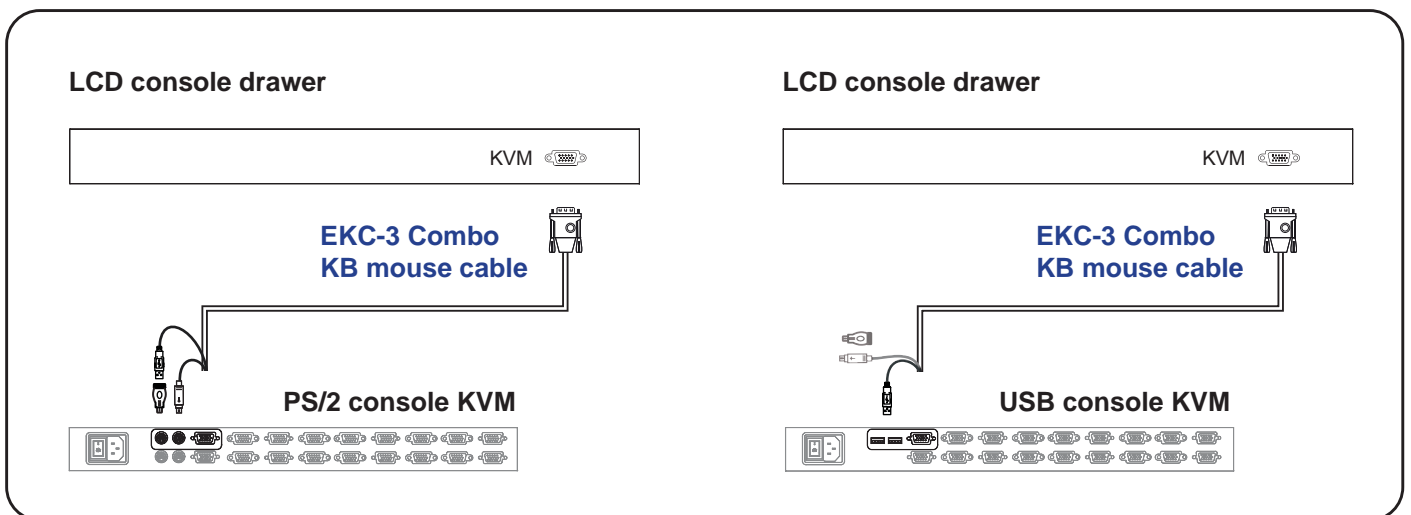

**Caution :** The keyboard drawer is hot-pluggable, but components of connected devices, such as the servers and KVM switch, may not be hot-pluggable. Plugging and unplugging cables while servers and KVM are powered on may cause irreversible damage to the servers, KVM and keyboard drawer. Before attempting to connect anything to the keyboard drawer, we suggest turning off the power to all devices. Apply power to connected devices again only after the keyboard drawer is receiving power. The company is not responsible for damage caused in this way.

## < Part 2 >

### < 2.1 > Standard Keyboard / Mouse Specifications

**Ge** G keyboard integrated with touchpad

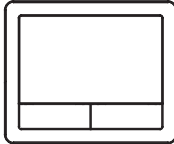
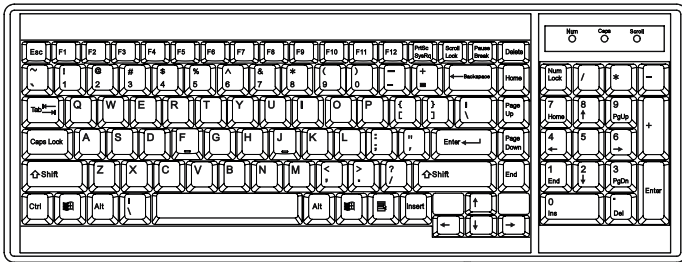

**Gb** G keyboard integrated with trackball

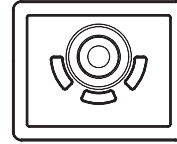
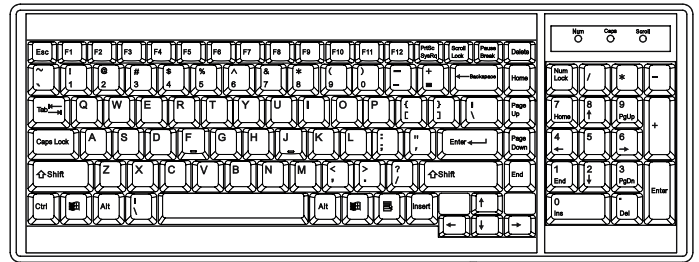

<b>Key force</b>	55 ± 5g
<b>Travelling distance</b>	3 ± 0.3mm
<b>Switch life</b>	> 10 million life cycle time
<b>Software support</b>	MS Windows 7 / 2008 / 2003 / 2000 / XP / ME / 98 / DOC Linux / Mac

#### Supporting layouts

America



United States



United Kingdom



Germany



France



Spain



Norway

EMEA



Italy



Russia



Switzerland



Netherlands



Portugal

Asia



China



Japan



Korea



Arabia



Turkey



**Me** MAC keyboard integrated with touchpad

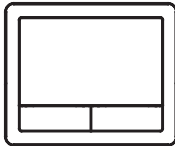
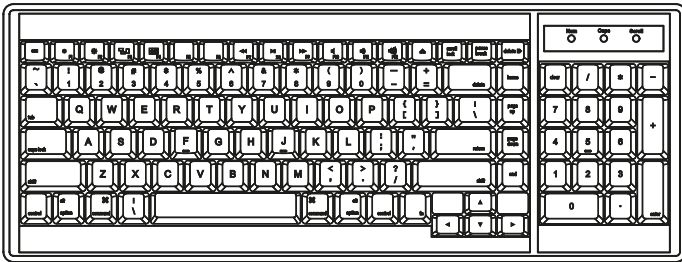

**Mb** MAC keyboard integrated with trackball

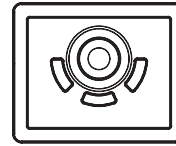
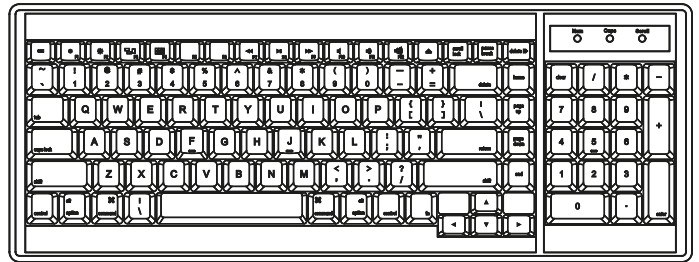

**Supporting layouts**

America  United States

**How to Use "MAC" Keyboard**

**Keyboard Features**

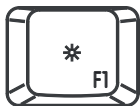

**F1**  
Decrease display brightness

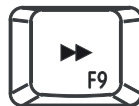

**F9**  
Fast-forward

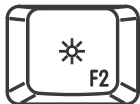

**F2**  
Increase display brightness

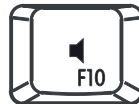

**F10**  
Mute sound



**F3**  
Mission control  
\* Only works with OS X Lion default Keyboard Shortcuts.



**F11**  
Decrease volume



**F4**  
Dashboard



**F12**  
Increase volume

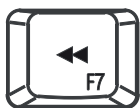

**F7**  
Rewind

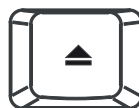

**Eject disc**



**F8**  
Play / Pause



**Command**

## < 2.1 > SUN Keyboard / Mouse Options

**GSe**

GS keyboard integrated with touchpad

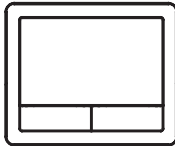
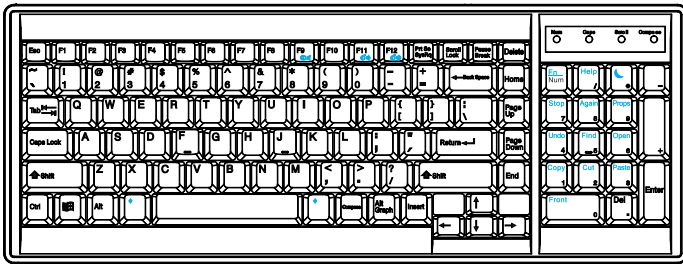

**GSb**

GS keyboard integrated with trackball

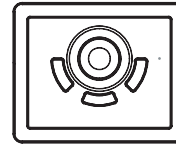
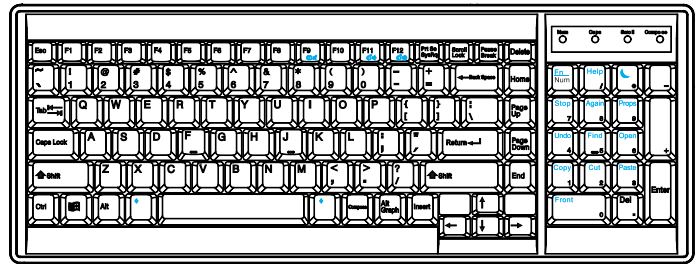

### GS keyboard integrated with touchpad / trackball



- Incorporates SUN keys, including Stop, Cut, Paste, Compose, Copy and Help
- 104 key notepad keyboard with full numerical pad and SUN function
- USB interface
- US layout only

### How to Use "GS" Keyboard

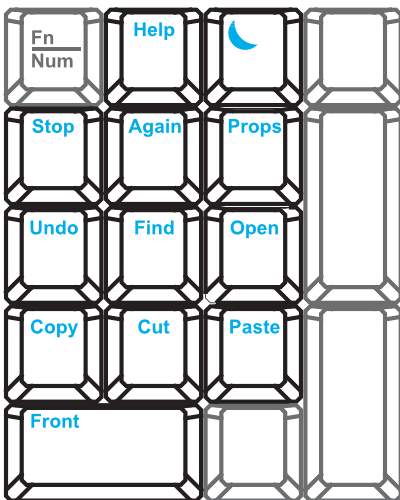

#### Num LED in Off mode

Key pad behaves as a SUN Solar system administration command mode

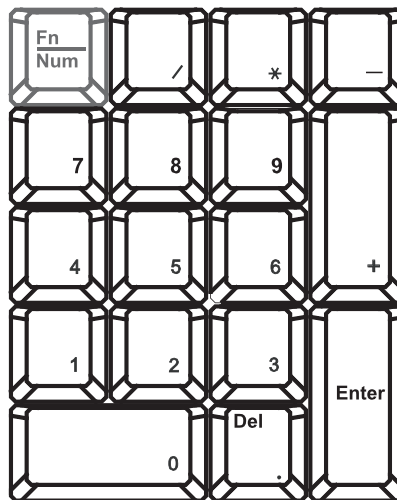

#### Num LED in Green mode

Key pad behaves as a normal key pad mode

### Audio / Display Keys

\* Please ask your supplier for full details

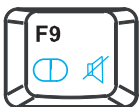

**F9**  
Audio : Mute  
Display : Degauss

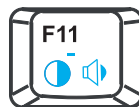

**F11**  
Audio : Decrease volume  
Display : Decrease contrast

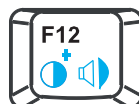

**F12**  
Audio : Increase volume  
Display : Increase contrast

## < 2.2 > Environmental Conditions

RK-2e / b

<b>Operating</b>	Temperature	0 to 55°C degree
	Humidity	20~90%, non-condensing
<b>Storage</b>	Temperature	-5 to 60°C degree
	Humidity	5~90%, non-condensing
	Shock	10G acceleration (11ms duration)
	Vibration	5~500Hz 1G RMS random

The company reserves the right to modify product specifications without prior notice and assumes no responsibility for any error which may appear in this publication.

All brand names, logo and registered trademarks are properties of their respective owners.

Copyright 2015 Austin Hughes Electronics Ltd. All rights reserved.