



# ADDERLink™ XD641 and XD642

User Guide



## Introduction

Welcome .....	2
CATx Link Cable Recommendations .....	3
AdderLink XD641 features .....	4
AdderLink XD642 features .....	5
Technical specifications .....	6
Supplied items .....	7
Optional extras .....	8

## Installation

Locations .....	9
Connections .....	9
Transmitter video link(s) .....	10
Transmitter audio links .....	10
Transmitter USB links .....	11
Transmitter Remote port .....	11
Transmitter power connection .....	12
Linking .....	13
CATx link .....	13
Fiber optic link .....	14
Receiver video display(s) .....	15
EDID management .....	15
Receiver audio devices .....	15
Receiver USB devices .....	16
Receiver Remote port .....	16
Receiver power connection .....	17

## Configuration

Accessing the Dashboard .....	18
Choosing the dual head mode (XD642 models only) .....	18
Resetting a module .....	19
Upgrading firmware .....	19

## Operation

Indicators .....	20
------------------	----

## Further information

Getting assistance .....	21
Appendix I - Remote port pin-out .....	22

## Index

# Introduction



## WELCOME

Thank you for choosing the ADDERLink® XD641 (single head) or XD642 (dual head) extender modules. Using either fiber optic or CATx links, these compact modules allow you to extend KVM connections over long distances from a host computer (see *Transmission distances when using fiber* on the right).

The high-grade screening employed within the metal cased enclosures, particularly when combined with the immunity from interference of the fiber optic links.

AdderLink XD64x extender modules provide support for:

- High quality single- or dual- digital video (up to 4K 4096 x 2160 @60Hz),
- USB keyboard and mouse plus two other USB devices (up to USB 2.0),
- An RS232 serial device at speeds up to 115200 baud,
- Mono microphone,
- Stereo speakers,
- Line-level audio in/out connections.

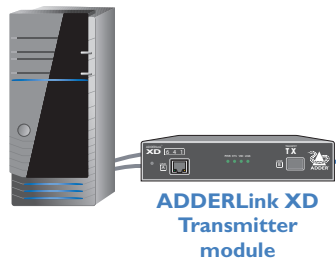

The ADDERLink extender modules are totally transparent in operation, leaving you free to use your computer as though you're still sitting next to it.

Fiber optic link  
(up to 4km)  
OR  
CATx link  
(CAT5e up to 50m)  
(CAT6 up to 100m)

## Transmission distances when using fiber

The choice of fiber used with the ADDERLink XD64x modules has a considerable effect on the distance over which operation can take place. Using multi-mode fiber you can achieve distances up to 400m (1,312 feet); whereas, by using single-mode fiber (and accompanying SFP+ modules), the achievable maximum distance is increased to 4km (2.5 miles):

Distance	Fiber type	Fiber color code	SFP+ module
70m	OM1 (TIA-492AAAA)	Orange	SFP-MM-LC-10G
150m	OM2 (TIA-492AAAB)	Orange	SFP-MM-LC-10G
380m	OM3 (TIA-492AAAC)	Aqua	SFP-MM-LC-10G
400m	OM4 (TIA-492AAAC)	Aqua	SFP-MM-LC-10G
4km	OS1 (TIA-492C000)	Yellow	SFP-SM-LC-10G
	OS2 (TIA-492E000)	Yellow	SFP-SM-LC-10G

Note: Adder supplied SFP+ modules are recommended. If using alternatives, ensure that they are 10G SFP+ parts with LC connectors.

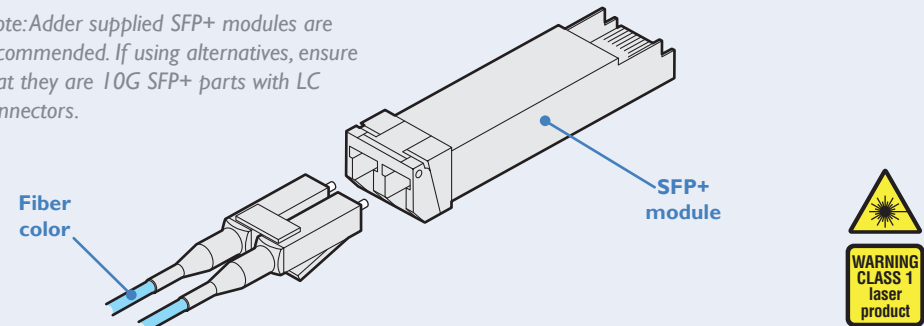

Single or dual (XD642 models) DisplayPort® video displays  
Four USB devices  
One RS232 serial device  
Stereo speakers plus microphone

INSTALLATION

CONFIGURATION

OPERATION

FURTHER INFORMATION

INDEX

## CATx Link Cable Recommendations

Due to the high data bandwidth required between the transmitter and receiver, ADDERLink XD600 series modules are highly dependent upon good quality CATx cable links. Video performance is particularly reliant on high speed communication channels.

The main factors that affect link quality are:

- The length and type of CATx cable used,
- The number, length and type of intermediate patch connections,
- The quality of the cable terminations.

CAT6 is recommended for CATx extensions, with a gauge (thickness) of at least 23AWG. Up to 5Gb/s of data may be transmitted, so the cable must be rated for at least 5GBase-T or 250MHz.

Patch links affect performance. For each additional break/patch within a run, the overall maximum extension is likely to be reduced. The amount will be dependent upon the nature of the patch panel. For best results, patch cables should be of type CAT6 and be less than 2 meters in length.

Use of CAT7 cables is not recommended. There is no associated ANSI/TIA specification for CAT7 resulting in a wide range of cable quality available, particularly with regard to shield grounding.

## ADDERLINK XD641 FEATURES

The transmitter and receiver modules are contained within slimline metal casings that measure just 186 x 152 x 40mm.

### Transmitter module

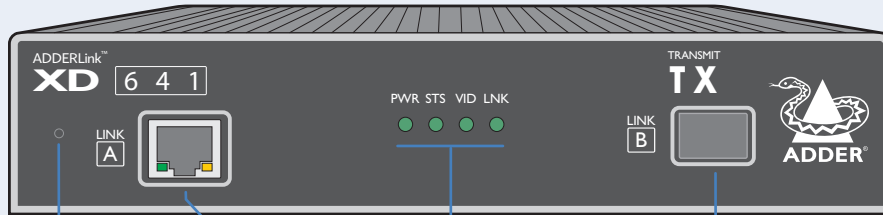

**Recessed reset button**  
See [Resetting a module](#).

**CATx port**  
Provides an alternative link method to fiber. See [CATx link](#).

**Status indicators**  
These provide visual confirmation of various system functions. See [Indicators](#) for further details.

**SFP+ slot**  
Accommodates a fiber optic SFP+ module of your choice. See [Fiber optic link](#) for further details.

**Audio ports**  
Connects to the audio output/input ports of your computer. See [Transmitter audio links](#) for further details.

**USB ports**  
Connect to USB ports on your computer. The outer-most port also supports USB audio streaming. See [Transmitter USB links](#) for further details.

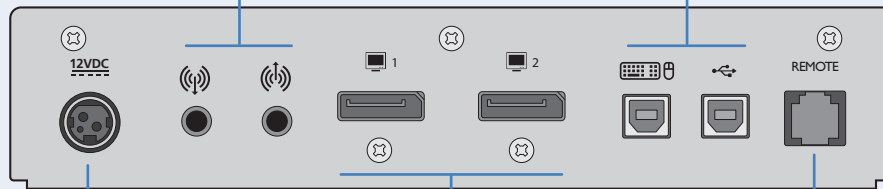

**Power input**  
See [Transmitter power connection](#) for further details.

**Video ports**  
Connect to the DisplayPort connectors of your computer. See [Transmitter video link](#) for further details.

**Remote port**  
Can be used for RS232 serial devices. See [Transmitter remote port](#) for further details.

### Receiver module

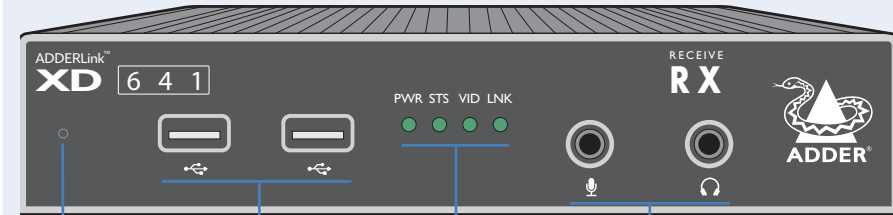

**Recessed reset button**  
See [Resetting a module](#).

**USB ports**  
Connect your USB keyboard, mouse and other HID peripherals. See [Receiver USB devices](#) for further details.

**Status indicators**  
These provide visual confirmation of various system functions. See [Indicators](#) for further details.

**Audio ports**  
Connect your microphone and headphones. See [Receiver audio devices](#) for further details.

**SFP+ slot**  
Accommodates a fiber optic SFP+ module of your choice. See [Fiber optic link](#) for further details.

**Video ports**  
Connect to your DisplayPort-equipped video displays. See [Receiver video display\(s\)](#) for further details.

**USB ports**  
Connect your USB keyboard, mouse and other HID peripherals. See [Receiver USB devices](#) for further details.

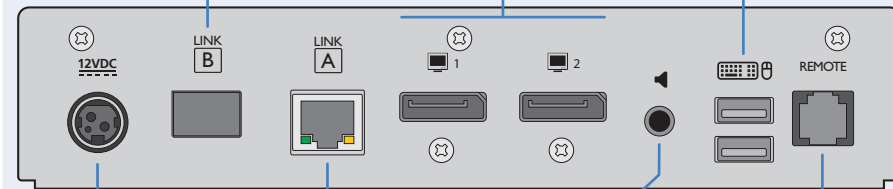

**Power input**  
See [Receiver power connection](#) for further details.

**CATx port**  
Provides an alternative link method to fiber. See [CATx link](#).

**Speaker port**  
Connect your speakers. See [Receiver audio devices](#) for further details.

**Remote port**  
Can be used for RS232 serial devices. See [Receiver remote port](#) for further details.

## ADDERLINK XD642 FEATURES

The transmitter and receiver modules are contained within slimline metal casings that measure just 186 x 152 x 40mm.

### Transmitter module

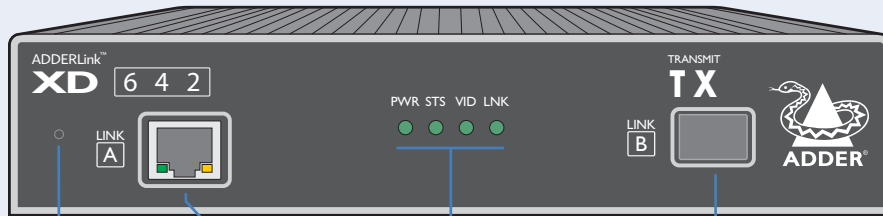

**Recessed reset button**  
See [Resetting a module](#).

**CATx port**  
Provides an alternative link method to fiber. See [CATx link](#).

**Status indicators**  
These provide visual confirmation of various system functions. See [Indicators](#) for further details.

**SFP+ slot**  
Accommodates a fiber optic SFP+ module of your choice. See [Fiber optic link](#) for further details.

**Audio ports**  
Connects to the audio output/input ports of your computer. See [Transmitter audio links](#) for further details.

**USB ports**  
Connect to USB ports on your computer. The outer-most port supports transparent USB. See [Transmitter USB links](#) for further details.

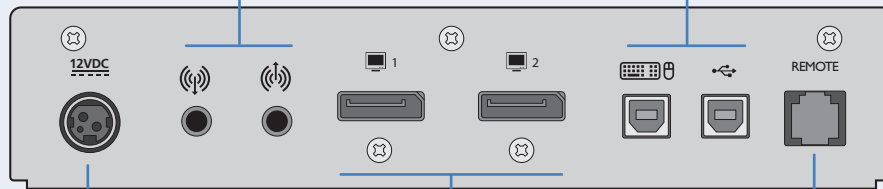

**Power input**  
See [Transmitter power connection](#) for further details.

**Video ports**  
Connect to the DisplayPort connectors of your computer. See [Transmitter video link](#) for further details.

**Remote port**  
Can be used for RS232 serial devices. See [Transmitter remote port](#) for further details.

### Receiver module

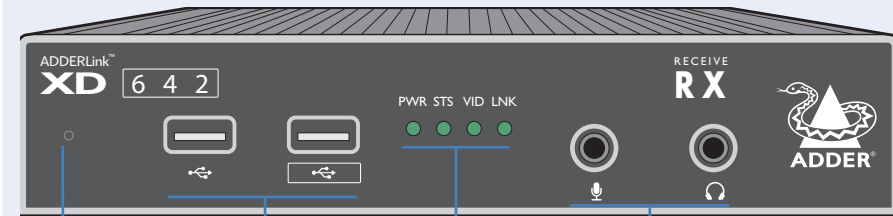

**Recessed reset button**  
See [Resetting a module](#).

**USB ports**  
The left port supports keyboard, mouse and other USB HID peripherals. The right port supports a wider range of devices. See [Receiver USB devices](#) for further details.

**Status indicators**  
These provide visual confirmation of various system functions. See [Indicators](#) for further details.

**Audio ports**  
Connect your microphone and headphones. See [Receiver audio devices](#) for further details.

**SFP+ slot**  
Accommodates a fiber optic SFP+ module of your choice. See [Fiber optic link](#) for further details.

**Video ports**  
Connect to your DisplayPort-equipped video displays. See [Receiver video display\(s\)](#) for further details.

**USB ports**  
Connect your USB keyboard, mouse and other HID peripherals. See [Receiver USB devices](#) for further details.

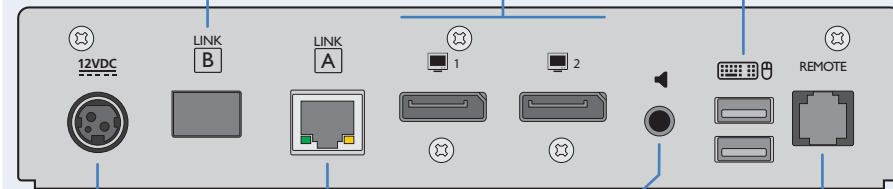

**Power input**  
See [Receiver power connection](#) for further details.

**CATx port**  
Provides an alternative link method to fiber. See [CATx link](#).

**Speaker port**  
Connect your speakers. See [Receiver audio devices](#) for further details.

**Remote port**  
Can be used for RS232 serial devices. See [Receiver remote port](#) for further details.



## TECHNICAL SPECIFICATIONS

### ADDERLink XD641

- Nominal Operating Power (W) 10W
- Peak Power (W) 12W
- External Power 12V DC, 1.5A
- Max operating Altitude (m) 2000m
- Operating Temp range (°C) 0 to +40°C
- Operating Humidity range (%RH) 0-80%
- Storage Temp range (°C) -10 to +50°C
- Storage Humidity range (%RH) 0-80%
- Max Thermal Dissipation (BTU) 41.94
- MTBF (Tx / Rx) 530k / 520k hours
- MTBF (Pair) 260k hours

#### Local unit – Transmitter (Tx)

- 4 x tri-color status indicators
- DisplayPort in and local pass-through out
- 2 x USB2.0 type B
- Line in and out analog audio
- RJ12 serial port
- RJ45 and SFP+ ports

#### Remote unit – Receiver (Rx)

- 4 x tri-color status indicators
- 2 x DisplayPort out (second port is a duplicate)
- 4 x USB2.0 type A
- Mic in, headset and speaker out
- RJ12 serial port
- RJ45 and SFP+ ports

#### Physical design

- Robust metal construction
- TX and RX: 186mm/7.32" (w), 39mm/1.54" (h), 148mm/5.83" (d)
- TX: 1.29kg / 2.84lbs
- RX: 1.24kg / 2.73lbs

#### Power supply

- 100-240VAC, 47-63Hz
- 12VDC 18W output from power supply unit.

### ADDERLink XD642

- Nominal Operating Power (W) 10W
- Peak Power (W) 12W
- External Power 12V DC, 1.5A
- Max operating Altitude (m) 2000m
- Operating Temp range (°C) 0 to +40°C
- Operating Humidity range (%RH) 0-80%
- Storage Temp range (°C) -10 to +50°C
- Storage Humidity range (%RH) 0-80%
- Max Thermal Dissipation (BTU) 41.94
- MTBF (Tx / Rx) 510k / 490k hours
- MTBF (Pair) 250k hours

#### Local unit – Transmitter (Tx)

- 4 x tri-color status indicators
- 2x DisplayPort in
- 2x USB2.0 type B
- Line in and out analog audio
- RJ12 serial port
- RJ45 and SFP+ ports

#### Remote unit – Receiver (Rx)

- 4 x tri-color status indicators
- 2 x DisplayPort out
- 3 x USB2.0 full speed, type A
- 1 x USB2.0 transparent Hi-Speed, type A
- Mic in, headset and speaker out
- RJ12 serial port
- RJ45 and SFP+ ports

#### Physical design

- Robust metal construction
- TX and RX: 186mm/7.32" (w), 39mm/1.54" (h), 148mm/5.83" (d)
- TX: 1.29kg / 2.84lbs
- RX: 1.24kg / 2.73lbs

#### Power Supply

- 100-240 VAC, 47-63Hz
- 12VDC 18W output from power supply unit.

# SUPPLIED ITEMS



## XD64x transmitter kit

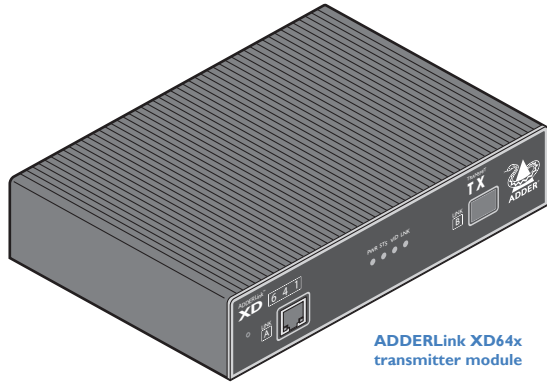

ADDERLink XD64x transmitter module

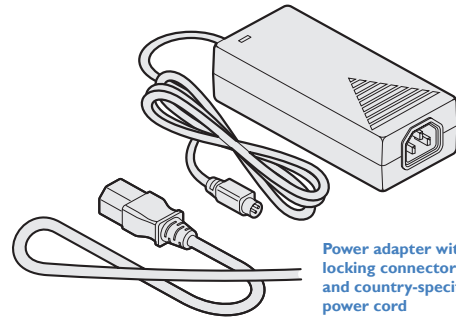

Power adapter with locking connector and country-specific power cord

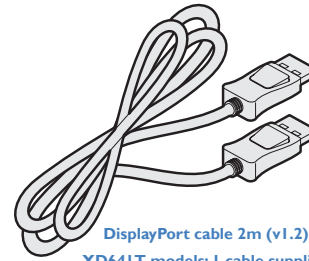

DisplayPort cable 2m (v1.2)  
XD641T models: 1 cable supplied  
XD642T models: 2 cables supplied

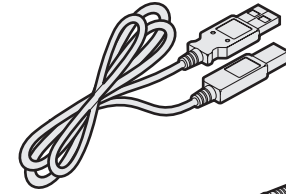

USB cable 2m (type A to B)

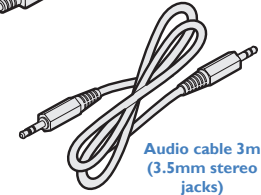

Audio cable 3m (3.5mm stereo jacks)

## XD64x receiver kit

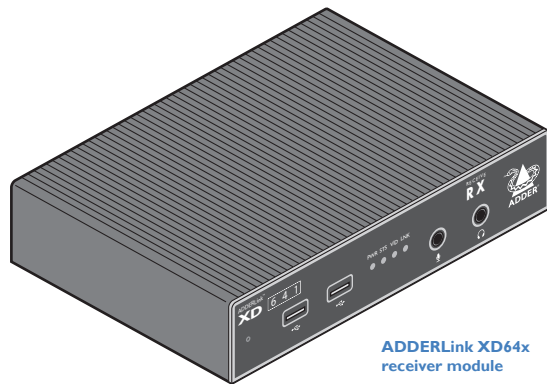

ADDERLink XD64x receiver module

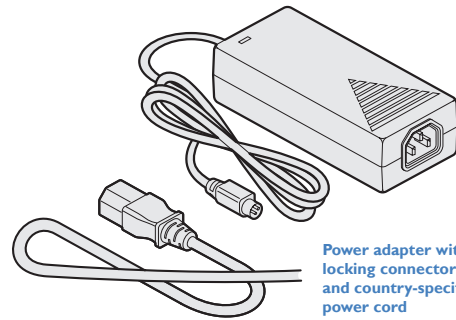

Power adapter with locking connector and country-specific power cord

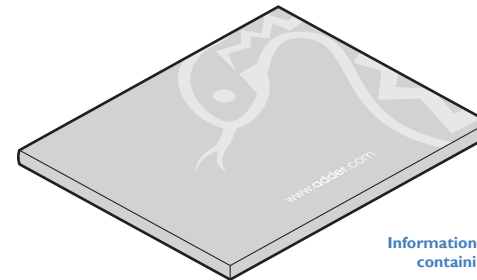

Information wallet containing:  
Quick setup guide  
Eight self-adhesive rubber feet  
Safety document

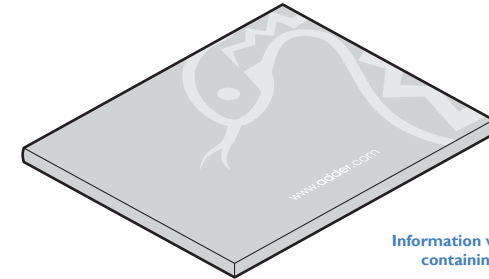

Information wallet containing:  
Quick setup guide  
Eight self-adhesive rubber feet  
Safety document

INSTALLATION

CONFIGURATION

OPERATION

FURTHER INFORMATION

INDEX



# OPTIONAL EXTRAS

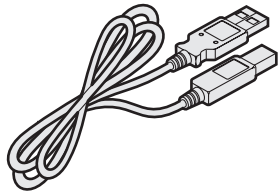

**USB cable 2m (type A to B)**  
Part number:VSC24

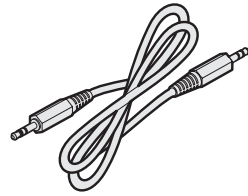

**Audio cable 2m (3.5mm stereo jacks)**  
Part number:VSC22

**Replacement power adapter with locking connector**  
Part number: PSU-IEC-12VDC-1.5A

**Country-specific power cords**  
CAB-IEC-AUS (Australia)  
CAB-IEC-EURO (Central Europe)  
CAB-IEC-UK (United Kingdom)  
CAB-IEC-USA (United States)  
CAB-IEC-JAPAN (Japan)

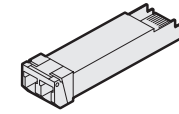
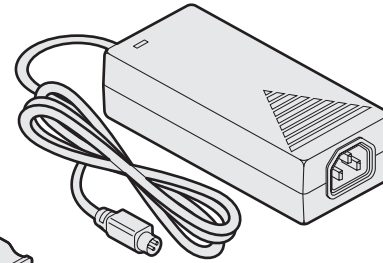

**SFP+ module with LC connectors**  
Multi mode: SFP-MM-LC-10G  
Single mode: SFP-SM-LC-10G

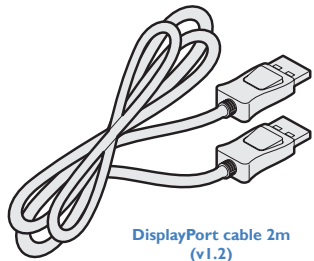

**DisplayPort cable 2m (v1.2)**  
Part number:VSCD18

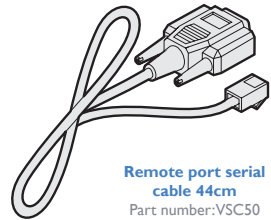

**Remote port serial cable 44cm**  
Part number:VSC50

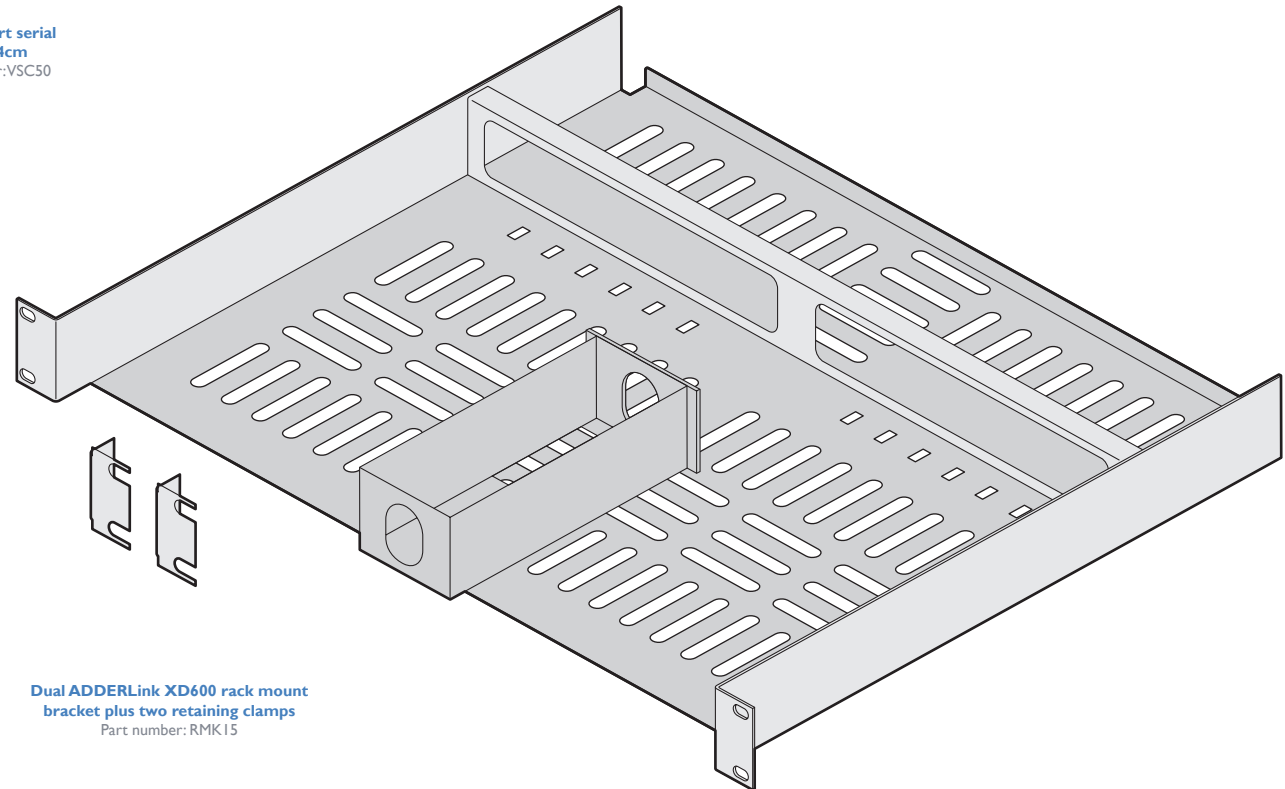
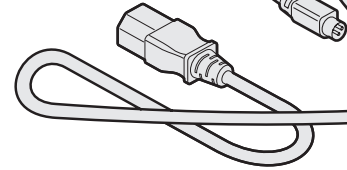

**Dual ADDERLink XD600 rack mount bracket plus two retaining clamps**  
Part number:RMK15

## LOCATIONS

Please consider the following important points when planning the position of the AdderLink XD64x modules:

- Situate the transmitter module close to the system to which it will be connected and near to a source of mains power. Place the receiver module in similar close proximity to the peripherals that it will connect with, plus a source of mains power.
- Consult the precautions listed within the supplied safety leaflet.
- Connections do not need to be carried out in the order given within this guide, however, where possible connect the *power in* as the final step.

Suitable for installation in Information Technology Rooms in accordance with Article 645 of the National Electrical Code and NFPA 75.

Peut être installé dans des salles de matériel de traitement de l'information conformément à l'article 645 du National Electrical Code et à la NFPA 75.

## CONNECTIONS

Installation involves linking the transmitter module to various ports on the host computer, while the receiver module is attached to your video display(s) and peripherals:

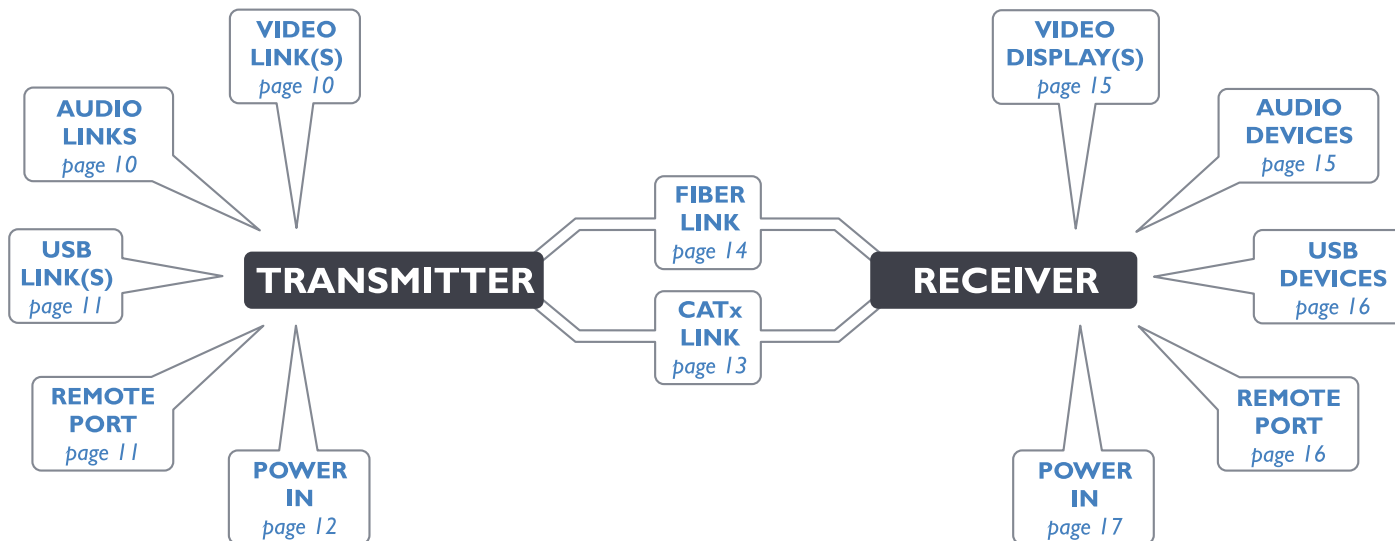

Click a connection to see details

## Transmitter video link(s)

AdderLink XD641 and XD642 modules can transfer various high resolution video modes via their DisplayPort connectors. The XD641 models support a single video display while XD642 models support dual video displays.

*Note: On XD642 models, dual video displays at 4K resolution are not possible using a CATx link - fiber must be used. However, dual WQXGA resolutions are possible using CATx.*

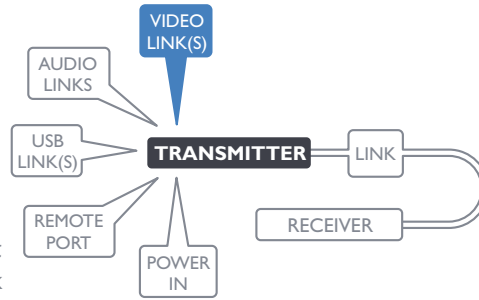

### To connect the video port(s)

- 1 Connect the supplied DisplayPort link cable between the video socket 1 on the transmitter module rear panel and the primary video output socket of the host computer.
  - 2 On XD642 models, optionally connect the (supplied) additional DisplayPort link cable between the video socket 2 on the transmitter module rear panel and the primary video output socket of the host computer.
- On XD641 models, optionally connect a local video display to video socket 2 on the transmitter module rear panel.

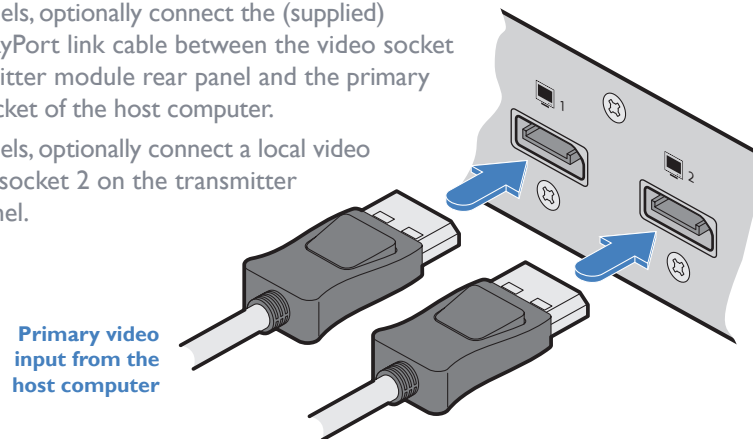

Primary video input from the host computer

**XD641 models:** Output to a local video display (optional)

**XD642 models:** Secondary video input from the host computer

## Transmitter audio links

The AdderLink XD64x modules support analog stereo audio in and out connections. Where necessary, make connections between the audio input and/or output ports of the host computer and the transmitter module.

*Note: Digital audio is also supported separately via the DisplayPort connectors as a transparent link-through.*

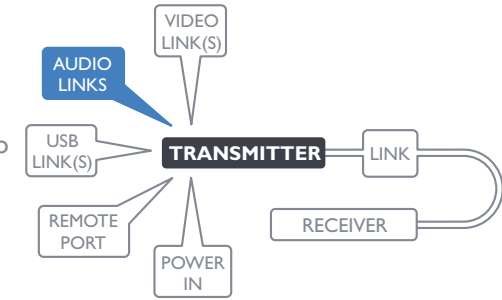

### To connect the audio ports

- 1 For the line in and/or line out ports, connect the supplied audio link cable between the audio port on the transmitter module rear panel and the line in or line out socket of the host computer.

From the audio output on the host computer

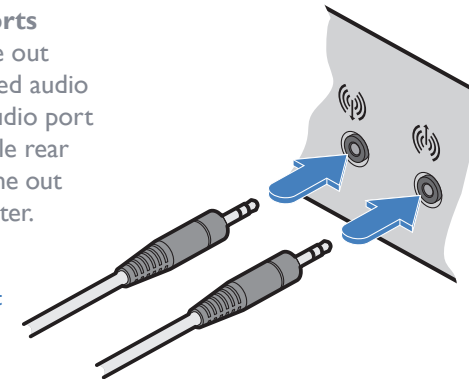

To the audio input on the host computer

## Video resolutions

The XD641 and XD642 extenders support, but are not limited to, the following common video resolutions (all at 60 fps):

1920 x 1080 (HD)	2560 x 2048 (QSXGA)
1920 x 1200 (WUXGA)	2048 x 1080 (2K)
2560 x 1080	2048 x 2160
2560 x 1440 (WQHD)	3840 x 2160 (UHD)
2560 x 1600 (WQXGA)	4096 x 2160 (4K)

## Transmitter USB links

The transmitter module has two USB input ports on its rear panel:

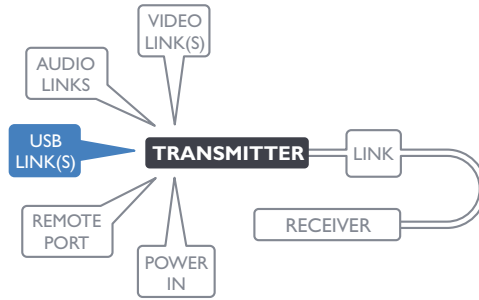
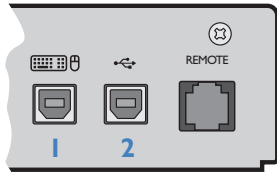

The ports have different functions depending on the model of ADDERLink XD64x that you are using:

	1	2
<b>XD641</b>	USB HID (Human Interface Device) feed to all USB ports on the receiver	USB audio feed to/from the analog audio ports labeled    on the receiver
<b>XD642</b>	USB HID (Human Interface Device) feed to all USB ports on receiver except the one labeled	Transparent USB feed to front panel socket labeled  on the receiver

## To connect the USB port(s)

1 Connect the type B connector of the supplied USB/video cable to the right-hand side USB port (labeled '2' on the diagram above) on the rear panel of the transmitter module.

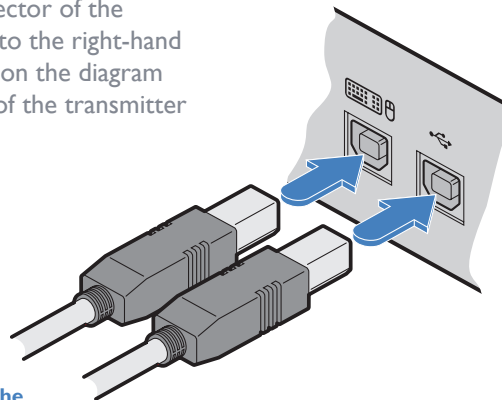

USB links from the host computer

- 2 Connect the type A connector of the cable to a vacant USB port on the host computer.
- 3 Repeat steps 1 and 2 for the second port if USB audio/transparent USB are required (see table above).

## Transmitter Remote port

The Remote port has a dual role, it can either:

- Allow an optional remote control to be connected to the module, or
- Create an RS232 serial connection with the receiver module.

When serial devices are attached to the Remote ports on the transmitter and receiver modules, the units transparently convey the signals between them at rates up to 115200 baud - no serial configuration is required. An optional serial cable (part number: VSC50) is available from Adder.

## To connect the Remote port

- 1 Use the optional serial cable (VSC50) to link the Remote port on the rear panel of the transmitter module with a vacant RS232 serial port on your host computer.

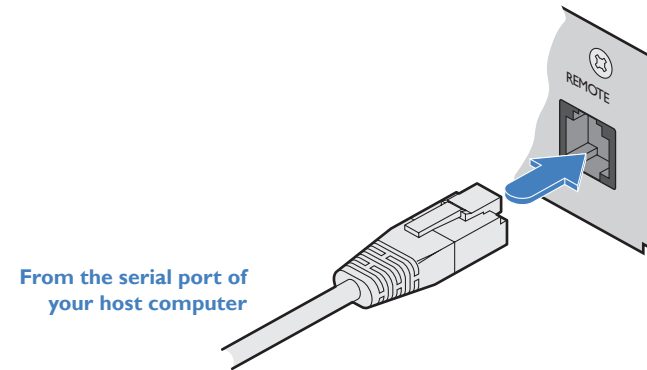
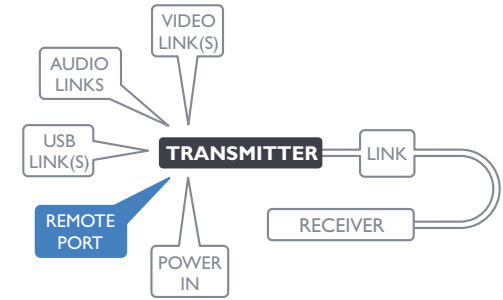

From the serial port of your host computer

Please see [Appendix 1](#) for pin-out details of the Remote port.

## Transmitter power connection

There is no on/off switch on either of the AdderLink XD64x modules, so operation begins as soon as power is applied. The power adapters supplied with the modules use locking-type plugs to help prevent accidental disconnections; please follow the instructions shown on the right whenever disconnecting a power adapter.

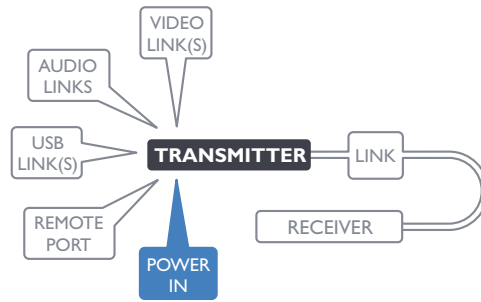

### To connect the power adapter

- 1 Attach the output plug of the supplied power adapter to the power input socket on the right side of the rear panel.

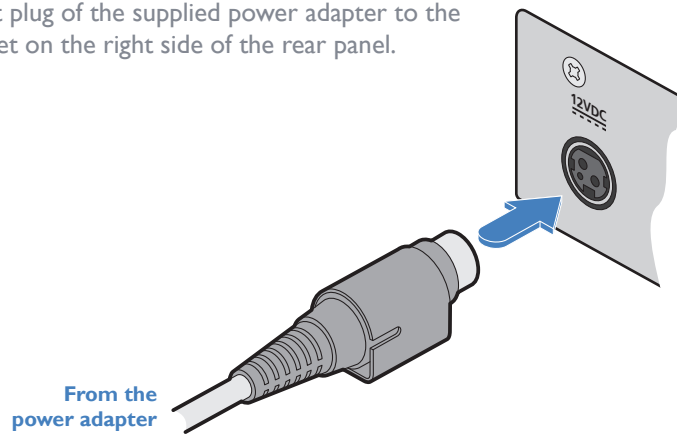

- 2 Connect the IEC connector of the supplied country-specific power cord to the socket of the power adapter.

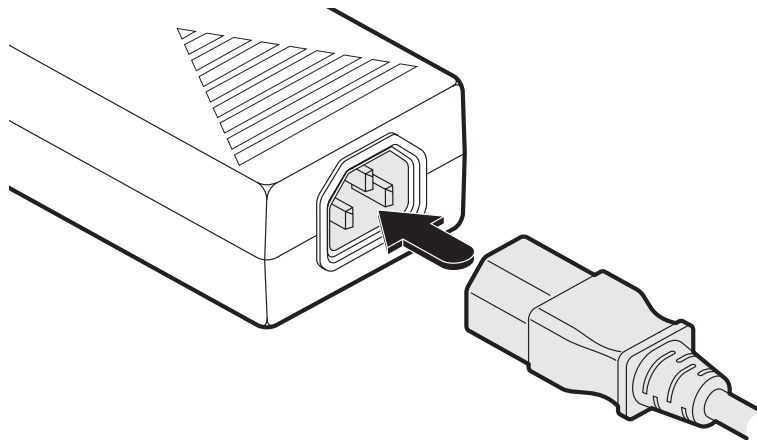

- 3 Connect the power cord to a nearby mains supply socket.

### To disconnect the power adapter

- 1 Isolate the power adapter from the mains supply.
- 2 Grasp the outer body of the power adapter plug where it connects with the module.
- 3 Gently pull the body of the outer plug away from the module. As the body of the plug slides back, it will release from the socket and you can fully withdraw the whole plug.

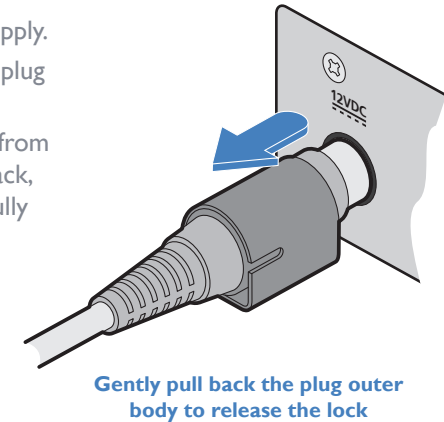

**IMPORTANT:** Please read and adhere to the electrical safety information given within the supplied safety leaflet. In particular, do not use an unearthed power socket or extension cable.

*Note: Both the modules and the power supplies generate heat when in operation and will become warm to the touch. Do not enclose them or place them in locations where air cannot circulate to cool the equipment. Do not operate the equipment in ambient temperatures exceeding 40 degrees Centigrade. Do not place the products in contact with equipment whose surface temperature exceeds 40 degrees Centigrade.*

## Linking

ADDERLink XD641 and XD642 units can be linked using either:

- CATx (see below), or
- Fiber (see next page)

When fiber is used there are no limits to the resolutions that can be transferred, up to the maximum 4K (4096 x 2160); when a CATx link is used, the maximum resolution for dual head installations on XD642 models will be WQXGA (2560 x 1600).

	Fiber	CATx
ADDERLink XD641	Single head at 4K maximum	Single head at 4K maximum
ADDERLink XD642	Dual head at 4K maximum	Single head at 4K maximum Dual head at WQXGA maximum
	Distances up to 4km	Distances up to 100m

## CATx link

The CATx ports on each module (labeled Link A) allow you to create direct links of up to 50m (when using CAT5e) or 100m (when using CAT6). In order to work in CATx mode, the SFP+ fiber modules must be removed from their sockets.

*Note: The CATx ports are not network ports and should not be connected to network switches or computer ports.*

### To make the CATx link

- 1 Connect a CATx (CAT 5e or 6 as required) cable between the Link A ports on the transmitter (front panel) and the receiver (rear panel):

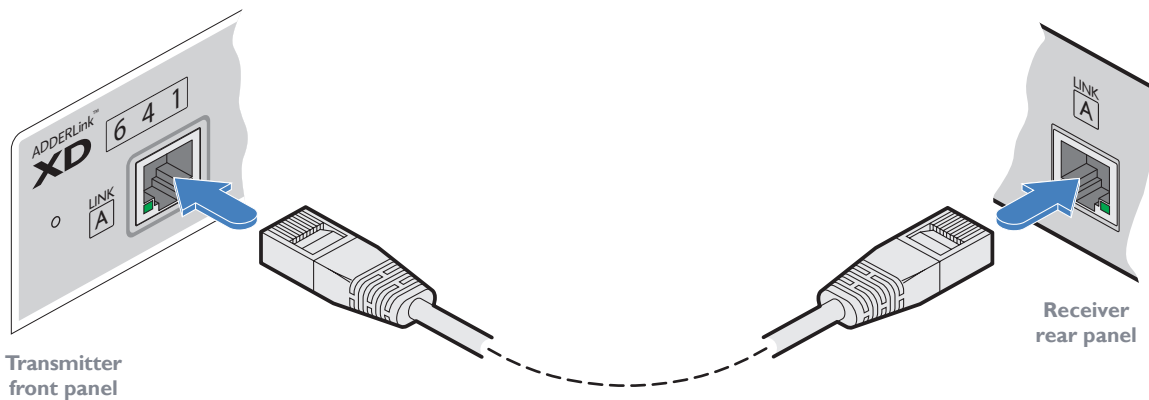

- 2 In operation, ensure that both indicators on the CATx connectors are green. See right.

## CATx status indicators

The status indicators on the CATx port connector of each module provide further status information when a CATx link is in use:

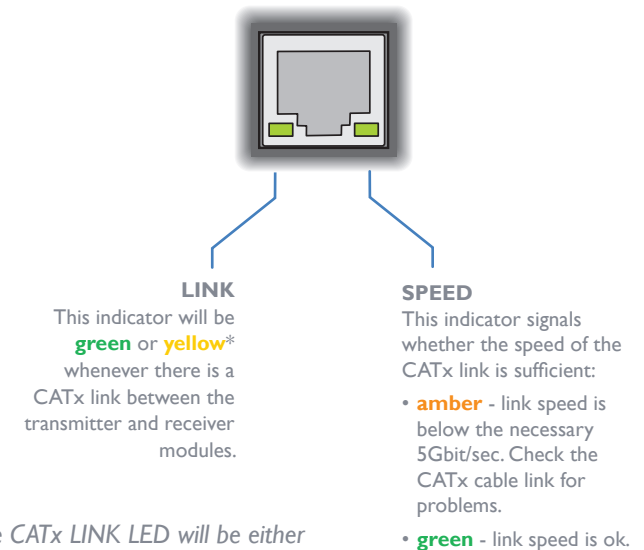

*\*The CATx LINK LED will be either yellow or green, depending upon the connector manufacturer used. There is no difference in functionality.*



## Fiber optic link

Each pair of AdderLink XD64x modules require optional SFP+ fiber optic modules of your choice (single or multi-mode). The fiber optic cable used must match the SFP+ type and also be of a suitable type for the distance being covered. See [Transmission distances](#) for details.

### To make the fiber optic link

**IMPORTANT:** Ensure the power supply is off/disconnected before inserting or removing an SFP+ module.

- 1 Remove an SFP+ module from its protective packing and insert it fully into the empty slot on the AdderLink XD641. The XD641 transmitter slot is located on the front panel; the XD641 receiver slot is situated on the rear panel:

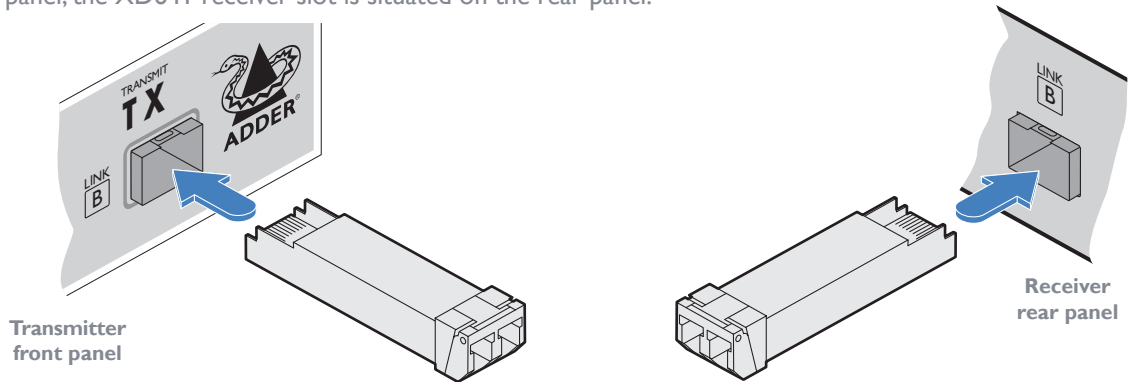

- 2 Repeat for the other SFP+ module on the other XD641.
- 3 For each SFP+ module, remove the black rubber insert that protects the sensors.
- 4 If fitted, remove the dual inserts that protect the fiber optic connectors.
- 5 Insert the fiber optic connectors into the SFP+ module so that they click into place:

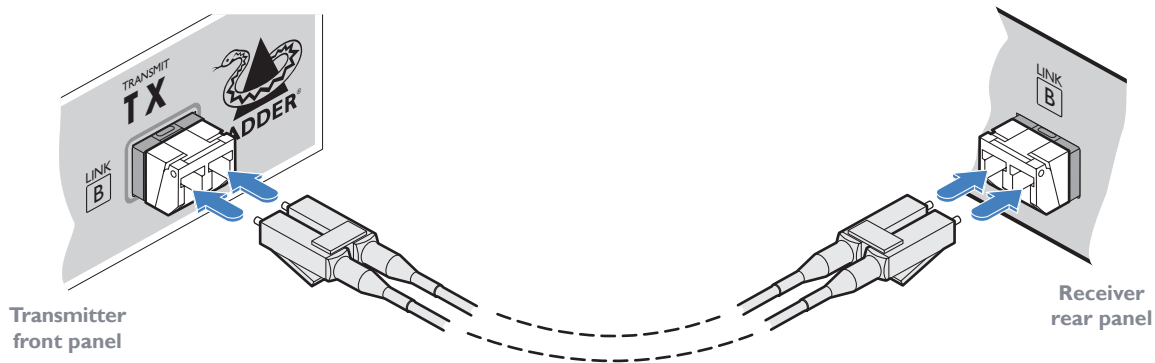

- 6 Repeat steps 4 and 5 at the other end.



*Note: In order to maintain a high level of confidence in the fiber optic link, it is recommended that Adder supplied SFP+s are used: (SFP-MM-LC-10G or SFP-SM-LC-10G).*

### To remove an SFP+ module

- 1 If fitted, remove the dual fiber optic connectors from the SFP+ module (press in the release tab of the fiber optic connectors to disengage them).
- 2 Unclip the small extraction lever and open it out (this action releases a locking tab and also provides a grip point).

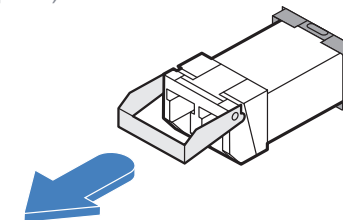

- 3 Gently pull on the extraction lever to withdraw the SFP+ module from the slot.
- 4 If the SFP+ module and/or fiber optic connector will remain unused for any period of time, be sure to fit the protective inserts to keep the optical interfaces clean.

## Receiver video display(s)

Two DisplayPort sockets are provided on the rear panel of each receiver module. On XD641 models, the signal from port 1 is duplicated on port 2. On XD642 models, ports 1 and 2 operate independently to supply the signals introduced to video ports 1 and 2 on the transmitter.

*Note: On XD642 models, dual video displays at 4K resolution are not possible using a CATx link - fiber must be used. However, dual WQXGA resolutions are possible using CATx.*

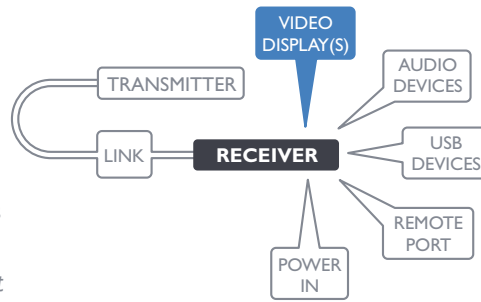

### To connect the video display

- 1 Connect the signal cable from your primary video display to port 1 on the rear panel of the receiver module.
- 2 Repeat for the secondary (or duplicate) video display on port 2.

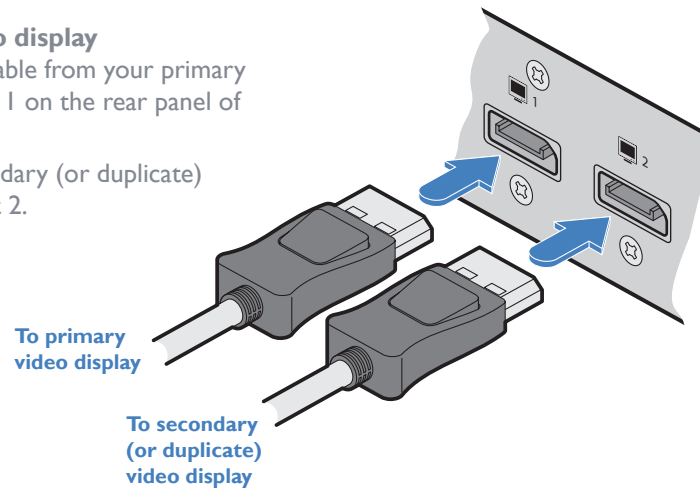

## EDID management

The EDID (Extended Display Identification Data) is read from the connected video display at the receiver module; it is then transferred to, and stored within, the transmitter module and then declared to the host computer. If the video display is removed then the cloned EDID stored at the transmitter module will still be presented to the video source.

### Video resolutions

The XD641 and XD642 extenders support, but are not limited to, the following common video resolutions (all at 60 fps):	1920 x 1080 (HD)	2560 x 2048 (QSXGA)
	1920 x 1200 (WUXGA)	2048 x 1080 (2K)
	2560 x 1080	2048 x 2160
	2560 x 1440 (WQHD)	3840 x 2160 (UHD)
	2560 x 1600 (WQXGA)	4096 x 2160 (4K)

## Receiver audio devices

The receiver module can support multiple analog audio devices, such as stereo headphones, a mono microphone or line-level in/out connections.

USB audio is also supported when the left hand USB socket on the XD641 rear panel is connected to the computer. The audio signals received from the computer will be transferred to the analog audio sockets on the receiver. USB audio will take precedence over the 3.5mm audio jacks when both sources are present.

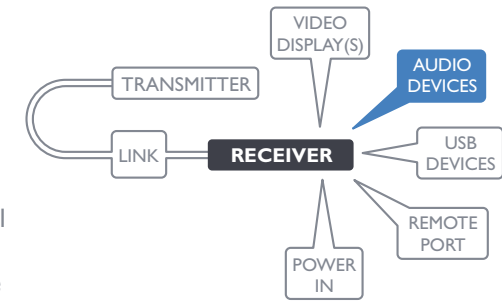

### To connect audio devices

- 1 Connect stereo headphones and/or a mono microphone to the 3.5mm jack audio sockets on the front panel of the receiver module.

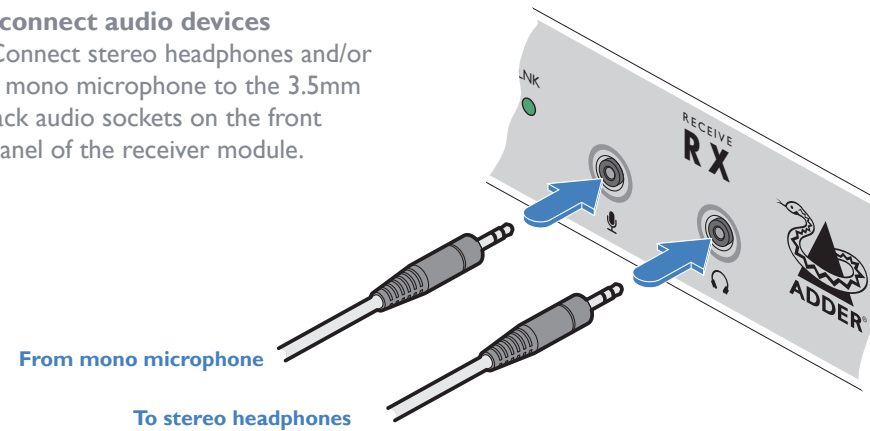

- 2 Optionally use the rear panel 3.5mm jack audio socket to connect line-level audio devices, such as powered speakers.



*Note: Digital audio sent via the DisplayPort connectors are passed straight through from the transmitter to the receiver ports and remain completely separate from the analog audio signals.*

## Receiver USB devices

Each receiver module contains a USB hub that can support multiple v2.0 or v1.1 USB HID (Human Interface Device) peripherals. On XD641 models, all four USB sockets are identical in operation. However, on XD642 models, three of the USB sockets are used for HID peripherals while the fourth, labeled  (on the front panel) is a fully transparent USB port capable of supporting a wider range of devices.

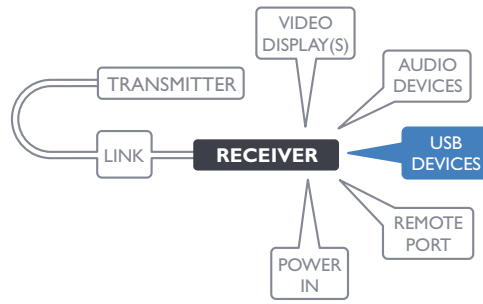

### To connect USB devices

1 Connect your USB keyboard, mouse and any other two USB devices to the four sockets distributed on the front and rear panels of the receiver module.

*Note: [XD642 models only] The front panel socket labeled  is a fully transparent USB port capable of supporting a wider range of devices, such as headsets, web cams and flash drives.*

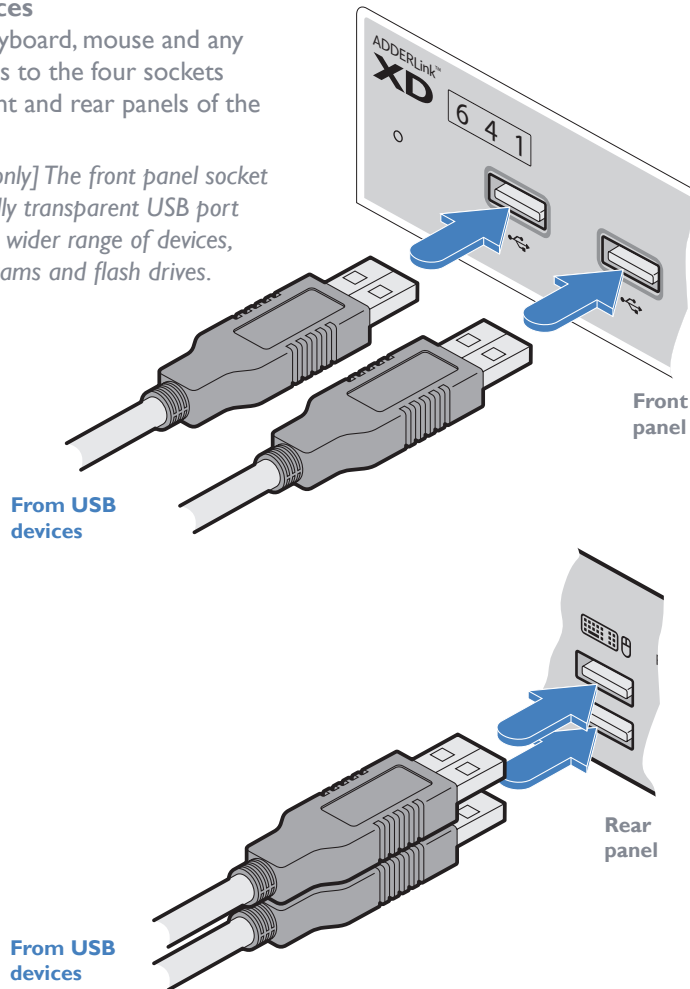

## Receiver Remote port

The Remote port has a dual role, it can either:

- Allow an optional remote control to be connected to the module, or
- Create an RS232 serial connection with the receiver module.

When serial devices are attached to the Remote ports on the transmitter and receiver modules, the units transparently convey the signals between them at rates up to 115200 baud - no serial configuration is required. An optional serial cable (part number: VSC50) is available from Adder.

### To connect the Remote port

1 Use the optional serial cable (VSC50) to link the Remote port on the rear panel of the transmitter module with a vacant RS232 serial port on your host computer.

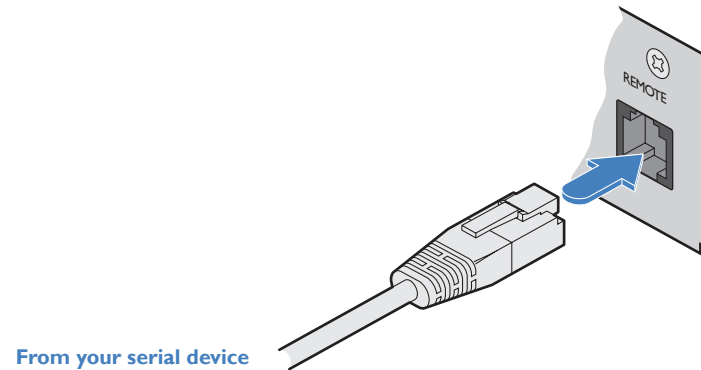
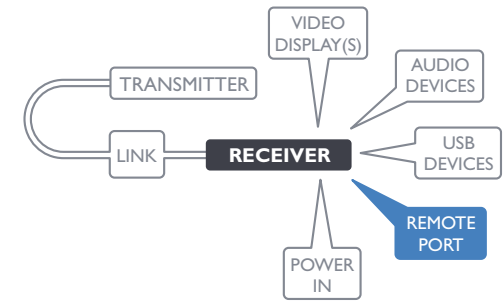

Please see [Appendix I](#) for pin-out details of the Remote port.

## Receiver power connection

There is no on/off switch on either of the AdderLink XD64x modules, so operation begins as soon as power is applied. The power adapters supplied with the modules use locking-type plugs to help prevent accidental disconnections; please follow the instructions shown on the right whenever disconnecting a power adapter.

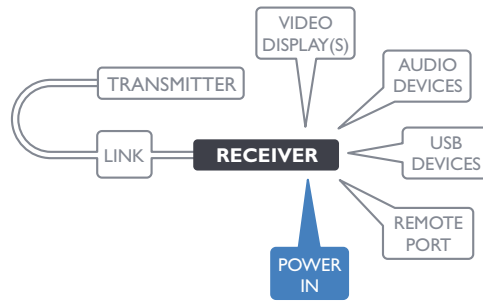

### To connect the power adapter

- 1 Attach the output plug of the supplied power adapter to the power input socket on the right side of the rear panel.

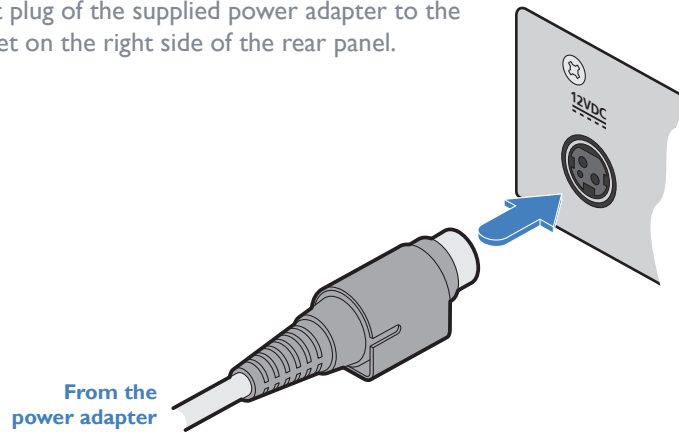

- 2 Connect the IEC connector of the supplied country-specific power cord to the socket of the power adapter.

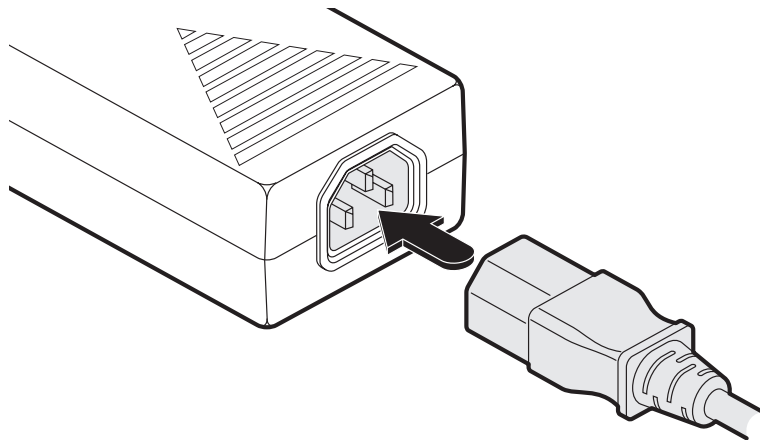

- 3 Connect the power cord to a nearby mains supply socket.

### To disconnect the power adapter

- 1 Isolate the power adapter from the mains supply.
- 2 Grasp the outer body of the power adapter plug where it connects with the module.
- 3 Gently pull the body of the outer plug away from the module. As the body of the plug slides back, it will release from the socket and you can fully withdraw the whole plug.

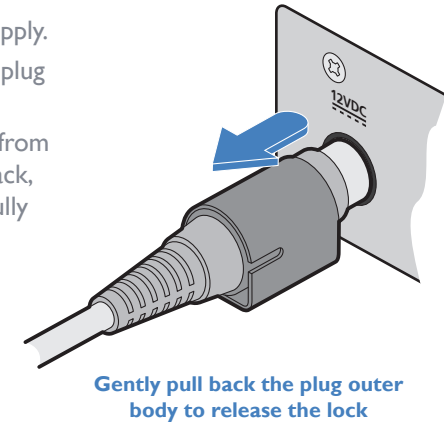

**IMPORTANT:** Please read and adhere to the electrical safety information given within the supplied safety leaflet. In particular, do not use an unearthed power socket or extension cable.

*Note: Both the modules and the power supplies generate heat when in operation and will become warm to the touch. Do not enclose them or place them in locations where air cannot circulate to cool the equipment. Do not operate the equipment in ambient temperatures exceeding 40 degrees Centigrade. Do not place the products in contact with equipment whose surface temperature exceeds 40 degrees Centigrade.*

## ACCESSING THE DASHBOARD

AdderLink XD64x modules generally configure themselves automatically, collecting EDID information from the attached monitor(s) and passing the details to the host computer. Unless an issue is encountered, the modules will begin working together correctly as soon as they are connected. The front panel indicators provide the primary source of status information, however, there is also a Dashboard popup which provides certain other details on the primary console display.

### To access the dashboard

1 Using your console keyboard attached to the receiver module, press (and release) the **Ctrl** key **three times** in quick succession (either of the keyboard's Ctrl keys can be used).

In response, the three keyboard indicators will all flash, once per second.

2 Press the numeric key **1** located above the main section of the keyboard (not the numeric keypad).

The Dashboard will be displayed, similar to this:

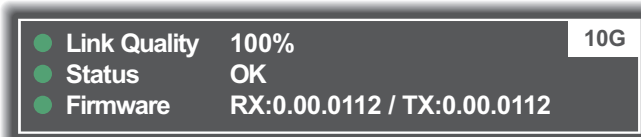

The example above shows a configuration that is working correctly.

If the communication link was working correctly, but the video signal was lost, it might report as follows:

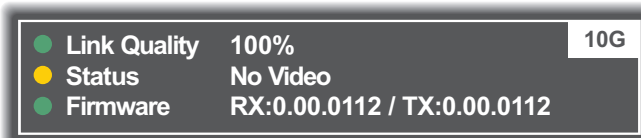

If the communication link was missing then the dashboard would report the issue similar to this:

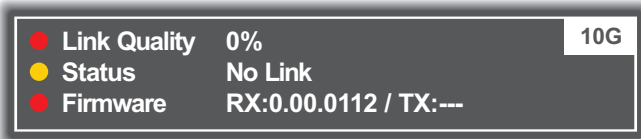

### To exit the dashboard

• Press (and release) the **Ctrl** key **three times** in quick succession and then press the numeric key **1** located above the main section of the keyboard (not the numeric keypad).

## CHOOSING THE DUAL HEAD MODE (XD642 models only)

When the CATx link is used to connect the transmitter and receiver modules, the available bandwidth is reduced. On XD642 models, if dual high resolution video displays are used, you can determine how the available bandwidth is shared between them. Two modes are available:

- **Balanced mode** - Shares the available video bandwidth equally between the two video displays, regardless of the EDIDs being reported by them, e.g. 1920x1200 each on video displays that would ordinarily request a native mode of 2560x1600.
- **Priority mode** - The primary video port will take priority, allowing it to display resolutions up to 4K, as reported by its EDID. The remaining bandwidth will be assigned to the second video head.

### To choose the dual head mode

1 Using your console keyboard attached to the receiver module, press (and release) the **Ctrl** key **three times** in quick succession (either of the keyboard's Ctrl keys can be used).

In response, the three keyboard indicators will all flash, once per second.

2 Press the numeric key located above the main section of the keyboard (not the numeric keypad) which represents the required mode:

- **6** for Balanced mode,
- **7** for Priority mode.

The current mode will be displayed on the Dashboard next to the link speed, eg BAL 5G, PRI 5G.

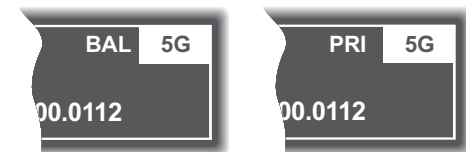

*Note: If you do not press any key within five seconds, or press any key other than the digits 1, 6 or 7 (or once you have successfully chosen an action), the keyboard will revert to normal operation. To use another hotkey function, repeat the whole procedure described above.*

The color of the Dashboard's **Link Quality** indicator matches the front panel **LNK** indicator:

- **Red** 0-25% quality
- **Amber** 25-50% quality
- **Yellow** 50-75% quality
- **Green** 75-100% quality

## RESETTING A MODULE

On the left side of the front panel of each module, you will find a small reset hole which is used to invoke special functions.

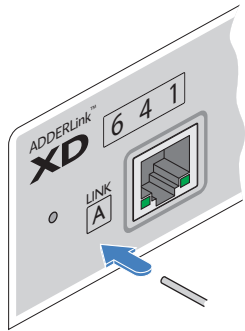

### To reset a module

- 1 Use a thin implement, such as a straightened paperclip to press and release the button concealed behind the small hole. The PWR indicator will show **red**.

After a few seconds, the indicator will change from **red** to **green** to show that the reset procedure is complete.

## UPGRADING FIRMWARE

Firmware upgrades are periodically made available for products via the Adder website ([www.adder.com](http://www.adder.com)). Use this procedure to upgrade the firmware in both ADDERLink XD64x extenders. *Note: Upgrades require roughly 6 minutes to complete.*

### To upgrade the firmware

- 1 Download the appropriate firmware upgrade file from the *Downloads* section of the ADDERLink XD64x product page within the Adder website. Copy the upgrade file to an empty (but FAT32-formatted) USB memory stick.
- 2 Ensure that the transmitter and receiver are linked and powered on. Also check that there are no USB drives inserted in the receiver module's ports.
- 3 On the receiver, press and hold a thin implement, such as a straightened paperclip, in the reset hole until the receiver's STS indicator flashes red/blue. The receiver is now in upgrade mode.
- 4 Wait for the LNK indicator to turn green, signifying that the link has been established. Video from the transmitter should be displayed and the STS indicator will continue to flash red/blue.
- 5 Insert the memory stick containing the upgrade file into the front panel left USB port.

The upgrade should begin and both units will flash their STS indicators red/green to show the upgrade process is in progress. Following a successful upgrade, both units will automatically reboot and run the new firmware. The STS indicator will show green for a copper connection and blue for fiber.

Display the Dashboard (see page 18) to view the upgrade progress. The Status field will display a message if an error occurs. In an error situation, it may be necessary to reboot the modules to use the existing firmware version.

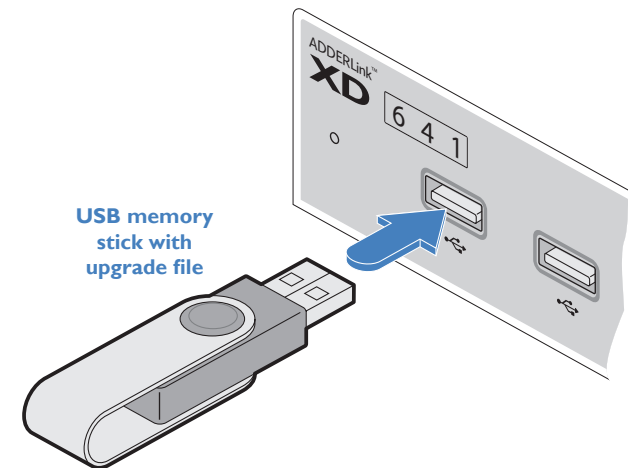
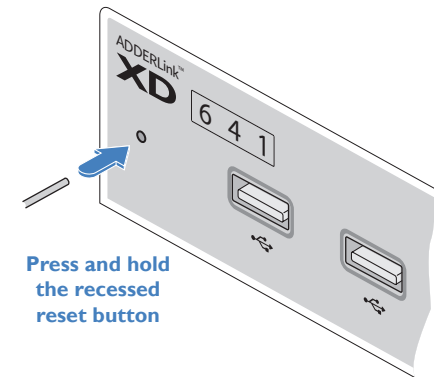



The AdderLink XD64x modules are designed to be transparent in operation; all peripherals should respond exactly as they would when situated next to your host computer.

## INDICATORS

The transmitter and receiver modules contain various indicators to provide you with status information. Both modules have four red indicators on their front panels.

### Status indicators

The multicolor status indicators on the front panels of each module mostly behave in the same manner at the same time:

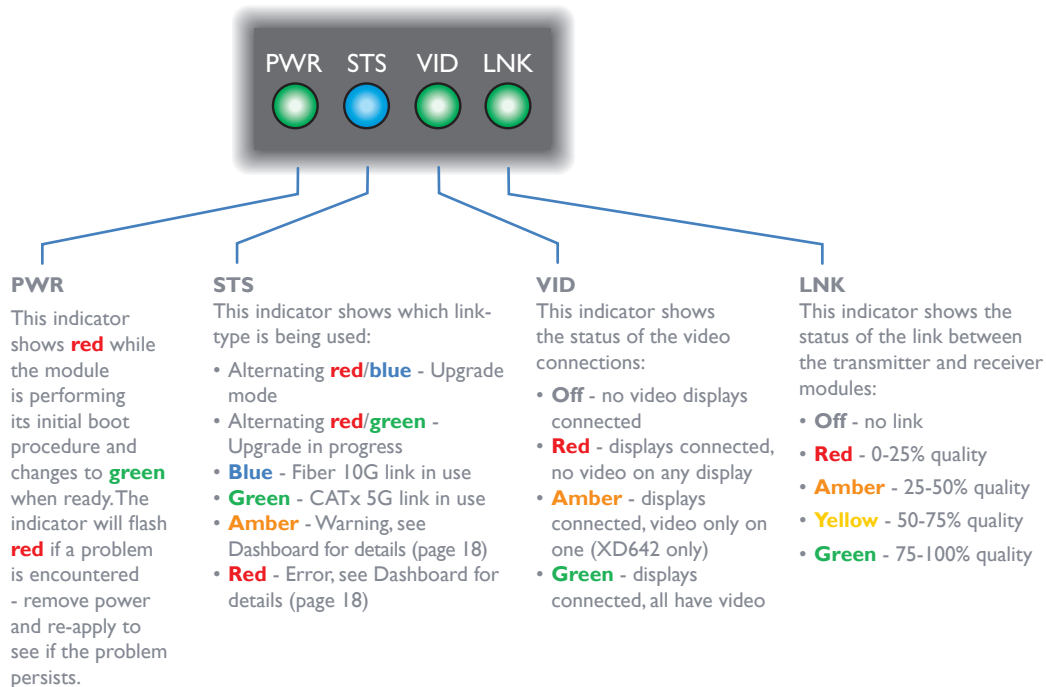

### CATx status indicators

The status indicators on the CATx port connector of each module provide further status information when a CATx link is in use:

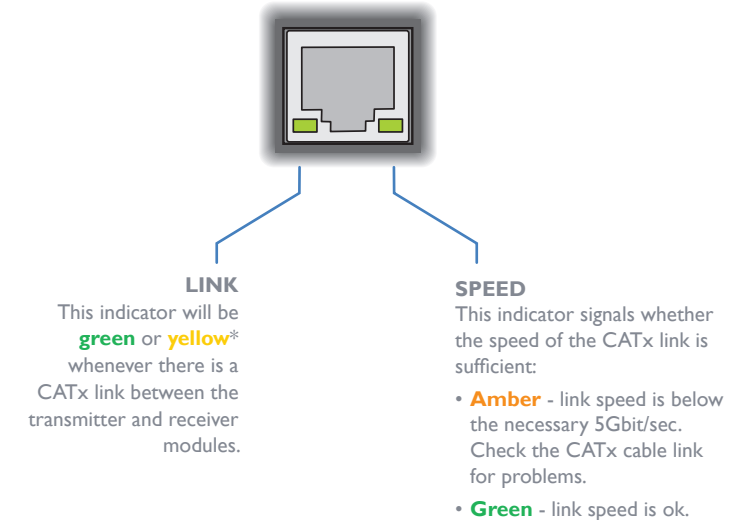

\* The CATx LINK LED will be either yellow or green, depending upon the connector manufacturer used. There is no difference in functionality.

# Further information



This chapter contains a variety of information, including the following:

- Getting assistance - see right
- [Appendix I](#) - Remote (Options) port pin-out

## GETTING ASSISTANCE

If you are still experiencing problems after checking the information contained within this guide, then please refer to the Support section of our website:

[www.adder.com](http://www.adder.com)

INSTALLATION

CONFIGURATION

OPERATION

FURTHER  
INFORMATION

INDEX

## APPENDIX I - REMOTE PORT PIN-OUT

The **REMOTE** port uses a 6p6c socket. The pin-out is listed below.

*Note: Although the pins labeled 'Not used' is inactive, it is still connected internally and so no links should be made at all to this pin.*

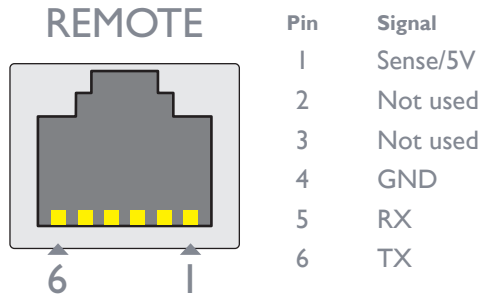

*Note: The TX detects presence of an incoming power signal to determine whether 5V should be supplied at the RX.*

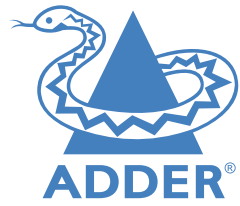

[www.adder.com](http://www.adder.com)

Documentation by:



[www.ctxd.com](http://www.ctxd.com)

© 2022 Adder Technology Limited  
All trademarks are acknowledged.  
Part No. MAN-000008 • Release 1.9

- A**
  - Audio devices
    - Receiver 15
  - Audio links
    - transmitter 10
- B**
  - Balanced mode 18
- C**
  - CATx
    - link 13
    - status indicators 13
  - Connections
    - overview 9
- D**
  - Dashboard 18
  - Dual head mode 18
- F**
  - Fiber
    - distances 2
  - Fiber optic
    - link 14
  - Firmware
    - upgrade 19
- H**
  - HID 11
- L**
  - Linking
    - overview 13
- O**
  - Optional extras 8
  - OSD
    - Dashboard 18
- P**
  - Power connection
    - Receiver 17
    - transmitter 12
  - Priority mode 18
- R**
  - Remote port
    - pin-out 22
    - Receiver 16
    - transmitter 11
  - Reset 19
- S**
  - SFP+ modules 2,14
  - Status indicators 20
  - Supplied items 7
- U**
  - Upgrade
    - firmware 19
  - USB devices
    - Receiver 16
  - USB links
    - transmitter 11
- V**
  - Video display(s)
    - Receiver 15
  - Video links
    - transmitter 10