



Introduction

Welcome	2
AdderLink dual 2U 12T unit features	3
Supplied items	4
Optional extras.....	5

Installation

Mounting	6
Connections	7
VNC network link.....	8
Video link	9
Audio links	10
USB link	10
AUX port.....	11
Power in	11
High speed links.....	12

Configuration

System and Teaming ports: Initial configuration.....	14
Manual factory reset.....	14
AdderLink Infinity browser-based configuration utility	15
A rough guide to configuring TX and RX units	16
TX (transmitter) unit configuration	16
RX (receiver) unit configuration.....	17
Performing an upgrade.....	19
Options switches.....	19

Operation

Front panel indicators	20
Using the VNC viewer.....	21

Further information

Getting assistance	22
Appendix A - Transmitter (TX) unit configuration pages.....	23
Appendix B - The VNC port: Initial configuration.....	30
Appendix C - Tips for success when networking ALIF units.....	38
Appendix D - Troubleshooting	40
Appendix E - Glossary	42
Appendix F - Configuration menus (via VNC)	45
Appendix G - VNC viewer connection options	57
Appendix H - VNC viewer window options.....	60
Appendix I - Java viewer options	61
Appendix J - The KVMADMIN utility	62
Appendix K - Known working video modes	63
Appendix L - Hotkey sequences.....	64
Appendix M - Cable pinouts, video modes and general specifications ..	65
Appendix N - Fibre modules and cables.....	66
Appendix O - Additional features.....	67
Warranty.....	68
Safety information	68
Radio frequency energy	69

Index

Introduction



WELCOME

Thank you for choosing the AdderLink Infinity dual 2112T transmitter, otherwise known as ALIF 2112T. ALIF 2112T represents a major advance in the capabilities of digital extenders and switches. By encoding high quality DVI video, digital audio and USB connections into Internet Protocol (IP) messages, ALIF dual offers very flexible signal switching and distribution capabilities.

Adder's extensive knowledge of interfacing techniques and high speed networking has allowed us to develop new ways to break the chains of local DVI, USB and audio connections. With ALIF dual, distance is finally no barrier to high specification, high performance computing. Furthermore, since all signals are now IP, the most elaborate and yet simple-to-use switching and multicast techniques make possible a great variety of uses.

In concert with a suitable ALIF receiver unit, the ALIF 2112T transmitter supports either two single link DVI video streams or one dual link (very high resolution) DVI video stream. This is in addition to a microphone, speakers and multiple USB peripherals. The distance between them is limited only by the size of your network.

ALIF 2112T provides a choice of link connections. Each unit supports both copper-based Gigabit Ethernet cabling as well as Fibre Channel over Ethernet (FCoE). These can be used in parallel to provide up to 2 Gigabit connection speeds with the added benefit of link redundancy that can maintain operation in the event of a failed connection.

Additionally, the ALIF 2112T has an in-built VNC server which allows it to stream low-bandwidth versions of its high-resolution output (via a dedicated Ethernet port on the front panel) so that it may be accessed remotely, via a VNC viewer, through any standard network.

Mixing ALIF and ALIF dual units

ALIF 2112T transmitters are complimentary to the standard AdderLink Infinity (1000 series) models which do not support dual DVI channels or fibre optic linking. It is possible to mix ALIF, ALIF dual and ALIF 2112T units on a network. However, whenever the two types are cross connected, the extra abilities of the ALIF dual/ALIF 2112T units will be temporarily disabled.

ALIF and A.I.M.

Where multiple ALIF units are used on a network, we have developed the AdderLink Infinity Management (A.I.M.) server to allow comprehensive and secure central control of all transmitters, receivers and users.



When using an A.I.M. server to configure ALIF units, it is vital that all ALIF units that you wish to locate and control are set to their factory default settings. Otherwise they will not be located by the A.I.M. server. If necessary, perform a [factory reset](#) on each ALIF unit.

One-to-one configuration

The simplest configuration links one RX unit to a single TX unit, either by a direct link or over much greater distances via a high speed network. In both cases, Gigabit cable linking and/or fibre can be used. When both are deployed, connection speeds of up to 2 Gigabits are possible.



One-to-many configuration

Using multicast techniques, an unlimited number of receivers* can receive video and audio data streams from a single TX unit.

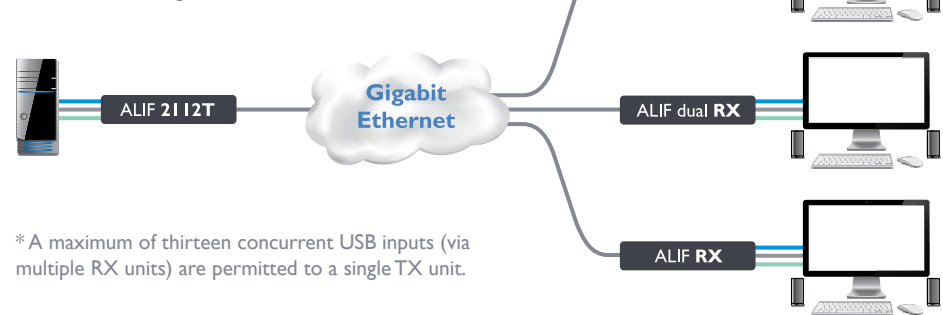

* A maximum of thirteen concurrent USB inputs (via multiple RX units) are permitted to a single TX unit.

Low bandwidth VNC connection

Up to sixteen remote users can log in via standard networks to view the output from the ALIF 2112T.

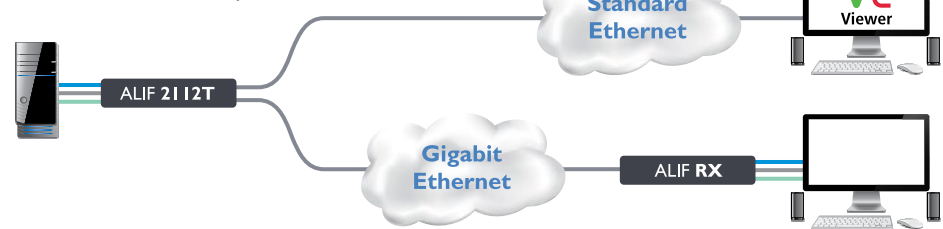

INSTALLATION

CONFIGURATION

OPERATION

FURTHER INFORMATION

INDEX

Please also see [Appendix C - Tips for success when networking ALIF units](#)

ADDERLINK DUAL 2112T UNIT FEATURES

The ALIF 2112T units are housed within durable, metallic enclosures with most connectors situated at the rear panel - the Ethernet ports are situated on the front panels. The smart front faces also feature the operation indicators.

Front

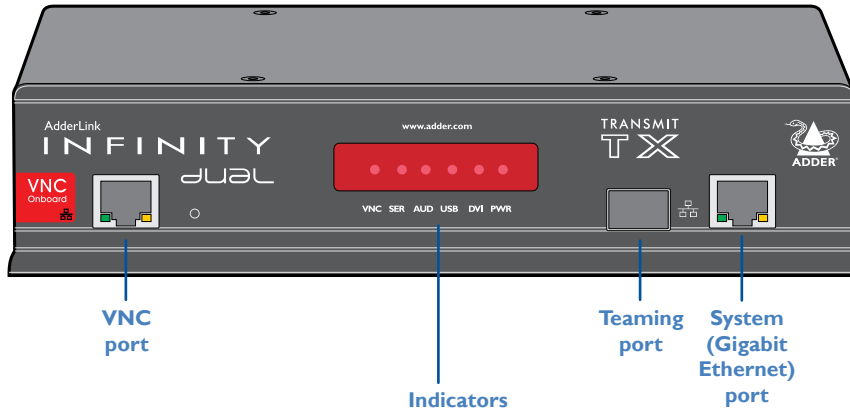

VNC port

Indicators

Teaming port

System (Gigabit Ethernet) port

These six indicators clearly show the key aspects of operation:

- **VNC** On when a VNC viewer is connected.
- **SER** On when the AUX (serial) port is enabled and active.
- **AUD** On when audio is enabled and active.
- **USB** On when USB is enabled and active.
- **DVI** On when either or both DVI Video channels are enabled.
- **PWR** Power indicator.

Rear

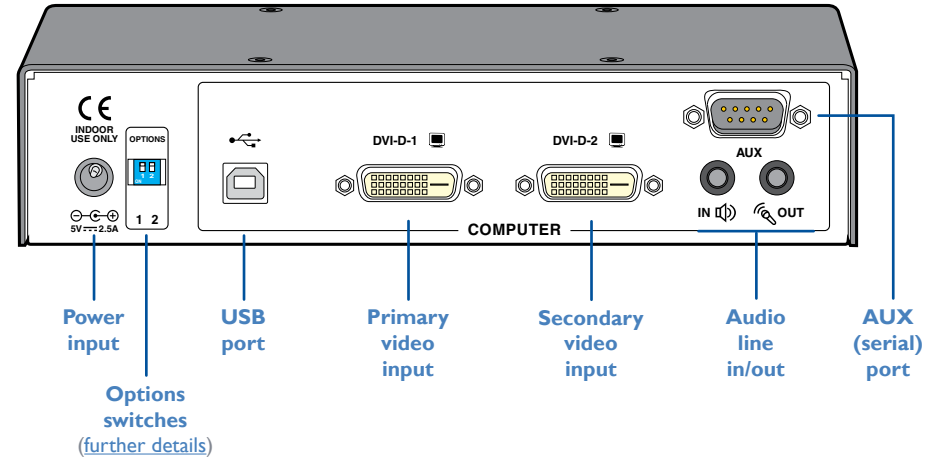

Power input

Options switches (further details)

USB port

Primary video input

Secondary video input

Audio line in/out

AUX (serial) port

SUPPLIED ITEMS

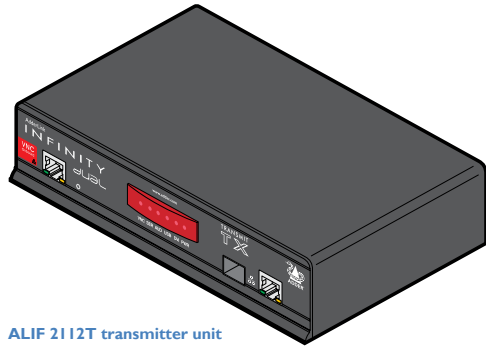

ALIF 2112T transmitter unit

Power adapter (20W) and country-specific power cord

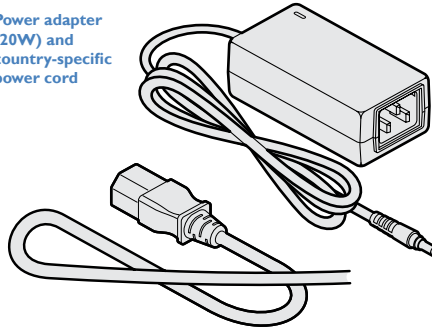

Single link DVI-D to DVI-D video cable

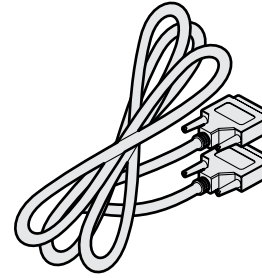

Combined DVI-D and USB cable (1.8m)

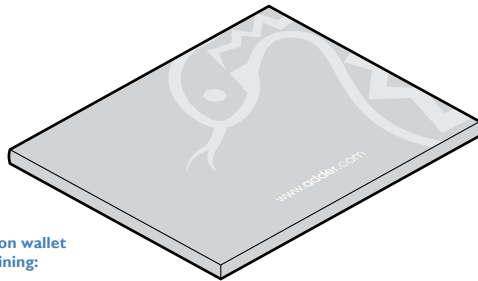
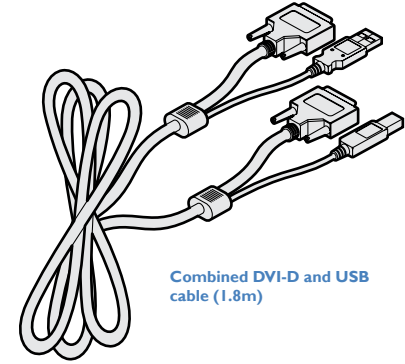

Information wallet containing:

- Four self-adhesive rubber feet
- Quick start guide
- Safety document

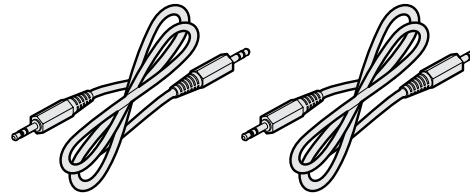

2 x Audio cable 2m (3.5mm stereo jacks)

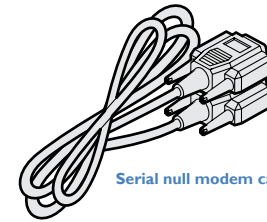

Serial null modem cable 2m

OPTIONAL EXTRAS

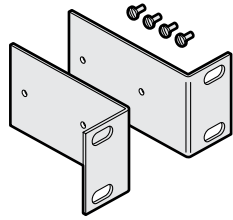

Two 19" rack-mount brackets and four screws

Part numbers:
One unit per 1U rack slot: RMK4S
Two units per 1U rack slot: RMK4D

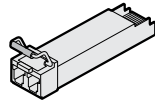

Single mode fibre SFP module
Part number: SFP-SM-LC

Please refer to the table in [Appendix M](#) for information about fibre modules and cables.

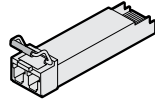

Multi mode fibre SFP module
Part number: SFP-MM-LC

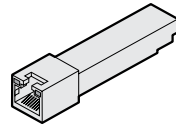

Active copper SFP module
Part number: SFP-CATX-RJ45

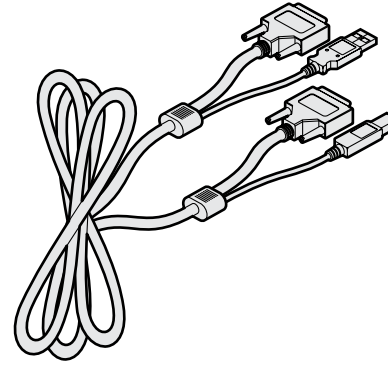

Combined dual link DVI-D and USB (USB type A to B) cable
Part numbers: VSCD3 (1.8m length)
VSCD4 (5m length)

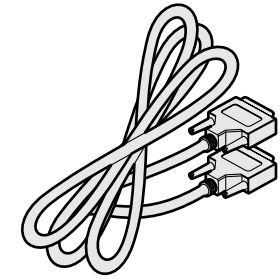

Single link DVI-D to DVI-D video cable
Part number: VSCD1

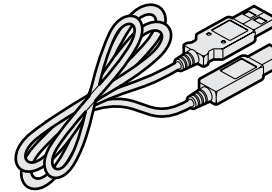

USB cable 2m (type A to B)
Part number: VSC24

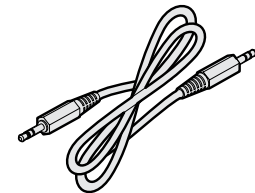

Audio cable 2m (3.5mm stereo jacks)
Part number: VSC22

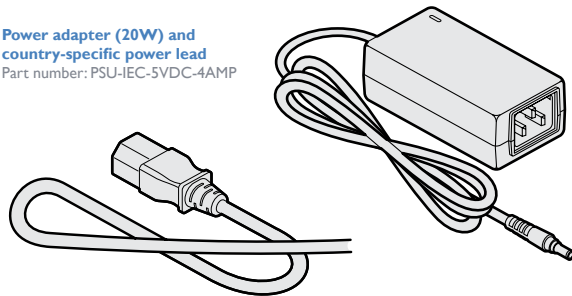

Power adapter (20W) and country-specific power lead
Part number: PSU-IEC-5VDC-4AMP

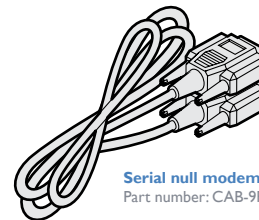

Serial null modem cable 2m
Part number: CAB-9F/9F-NULL-MODEM

MOUNTING

There are two main mounting methods for transmitter and receiver units:

- The supplied four self-adhesive rubber feet
- Optional rack brackets

[Connections](#)

Note: The ALIF 2112T and its power supply generate heat when in operation and will become warm to the touch. Do not enclose them or place them in locations where air cannot circulate to cool the equipment. Do not operate the equipment in ambient temperatures exceeding 40°C. Do not place the products in contact with equipment whose surface temperature exceeds 40°C.

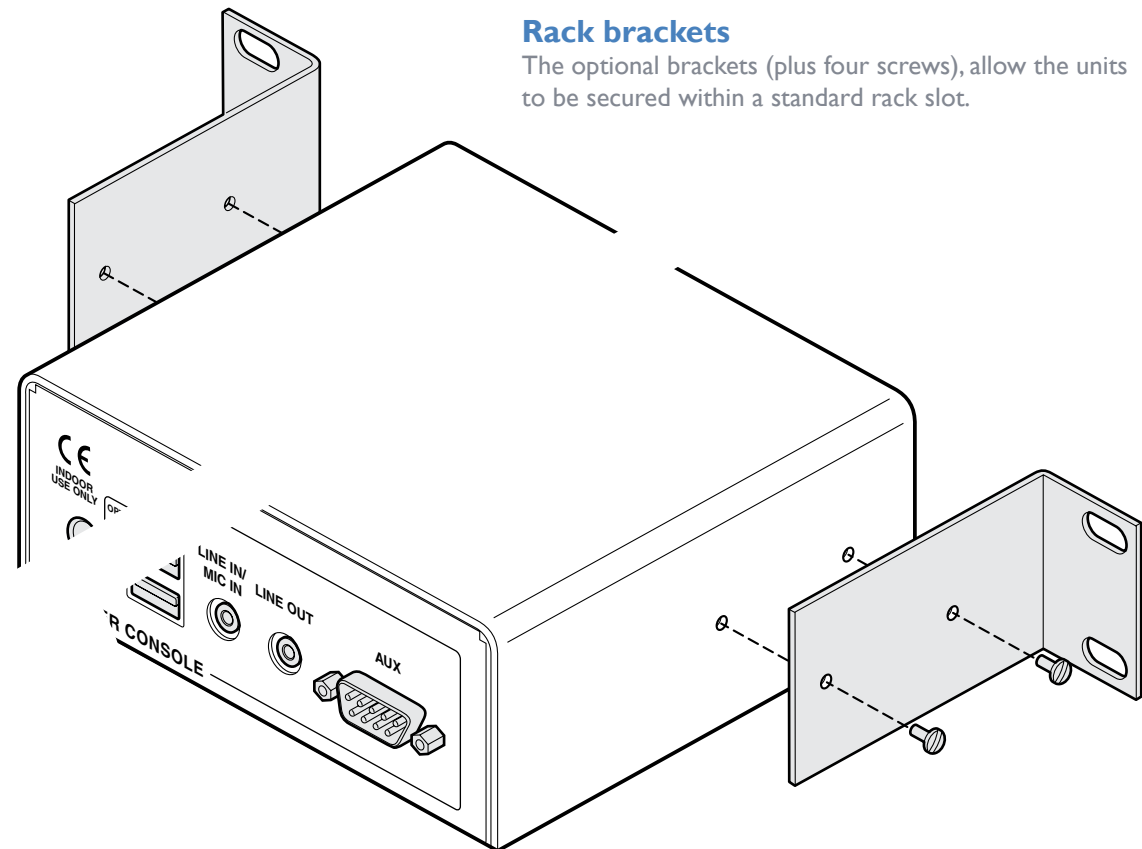

Rack brackets

The optional brackets (plus four screws), allow the units to be secured within a standard rack slot.

CONNECTIONS

Installation involves linking the ALIF 21 I2T unit to various ports on the host computer, while an ALIF RX unit is attached to your peripherals:

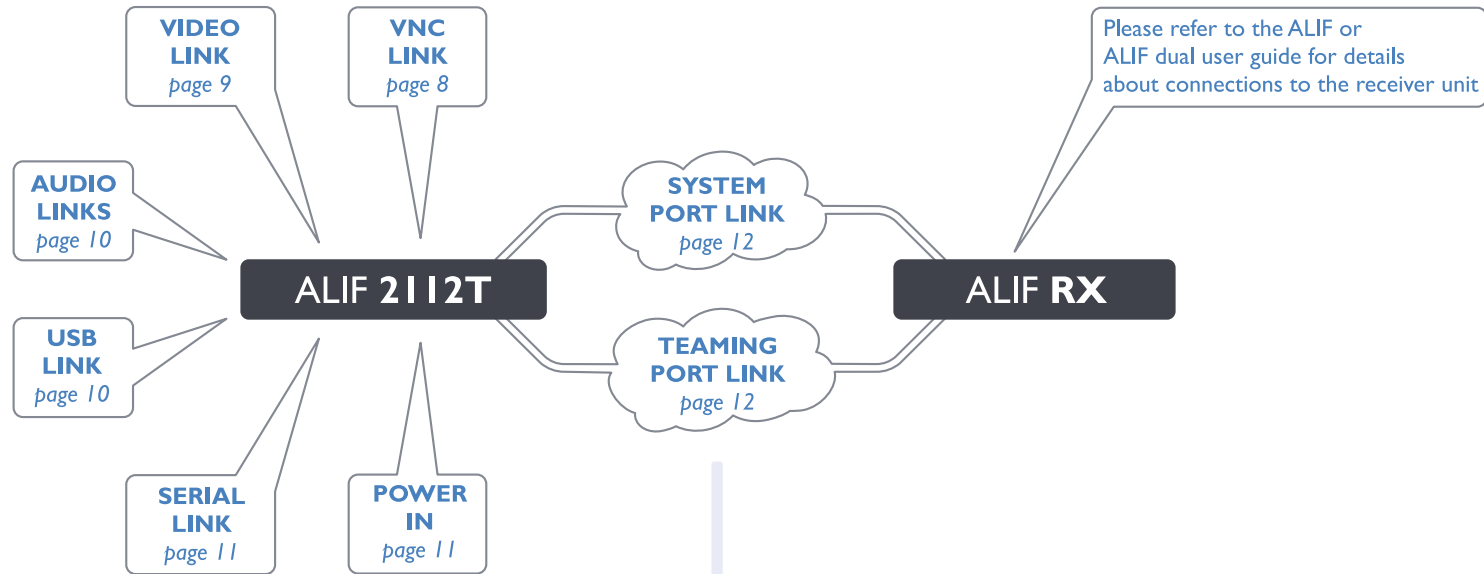

Click a connection to see details

IMPORTANT: When using an AdderLink Infinity Management box to configure ALIF units, it is vital that all ALIF units that you wish to locate and control are set to their factory default settings. Otherwise they will not be located by the A.I.M. server. If necessary, perform a [factory reset](#) on each ALIF unit.

Please also see [Appendix C - Tips for success when networking ALIF units](#)

VNC network link

The ALIF 2112T contains a VNC server that allows you to transmit a low-bandwidth version of the video output across standard networks to authorized remote viewers.

The VNC link can either be made over the same network as the main ALIF output or via a separate one. In either case, a separate VNC network port is located on the left side of the ALIF 2112T front panel for the purpose.

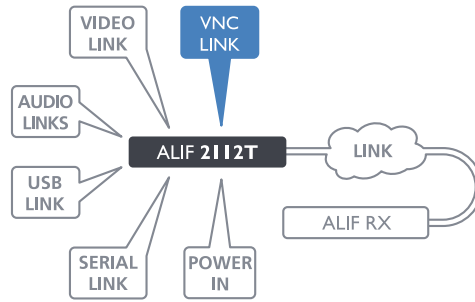

To make a VNC link

1 Connect a CAT 5, 5e, 6, or 7 cable to the socket on the front panel of the ALIF unit.

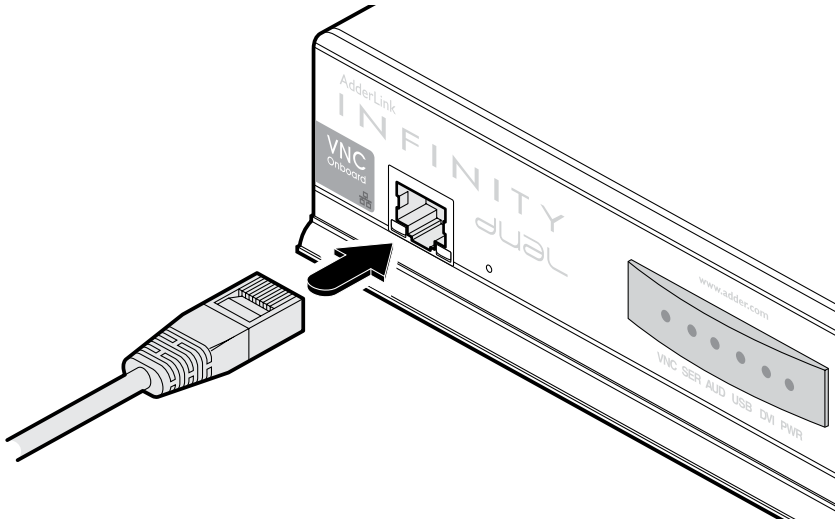

2 Connect the other end of the cable to an Ethernet switch.

Video link

ALIF dual units can simultaneously support up to two Single Link high resolution video displays at pixel clocks up to 165MHz; or can alternatively support a single Dual Link very high Resolution video display at pixel clocks up to 330MHz (equating to an example display mode of 2560 x 1600 at 60 Hz refresh).

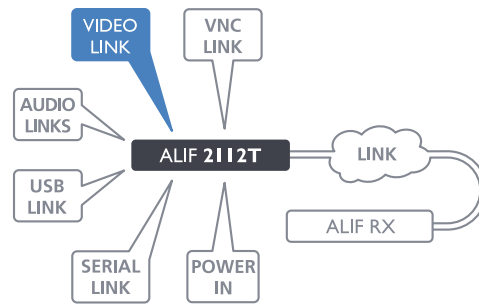

To make a video link

- 1 Wherever possible, ensure that power is disconnected from the ALIF and the host computer.
- 2 Connect either one or two digital video link cables to the DVI-D socket(s) on the TX unit rear panel:

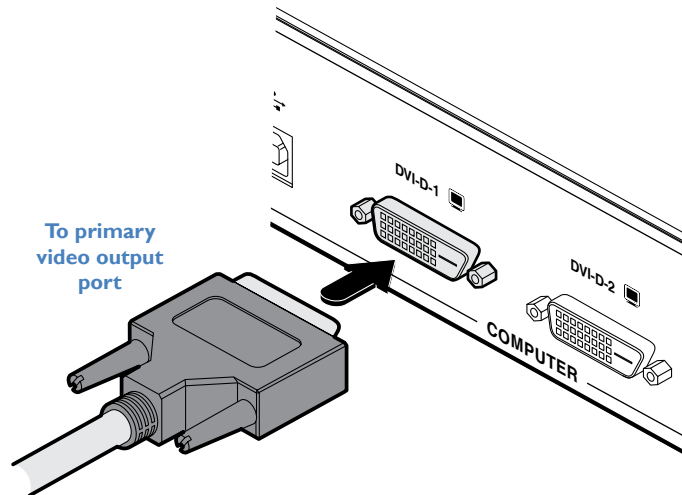

Note: When using one very high resolution DVI-D dual link display, use a DVI-D Dual Link cable (such as the supplied Adder part: VSCD3) to connect the primary video port of the computer system to the DVI-D-I connector of the ALIF dual. A dual link cable must also be used at the RX unit.

Note: When using two single link DVI-D displays, connect an additional video input from the secondary video port of the computer system using the supplied secondary DVI-D link cable.

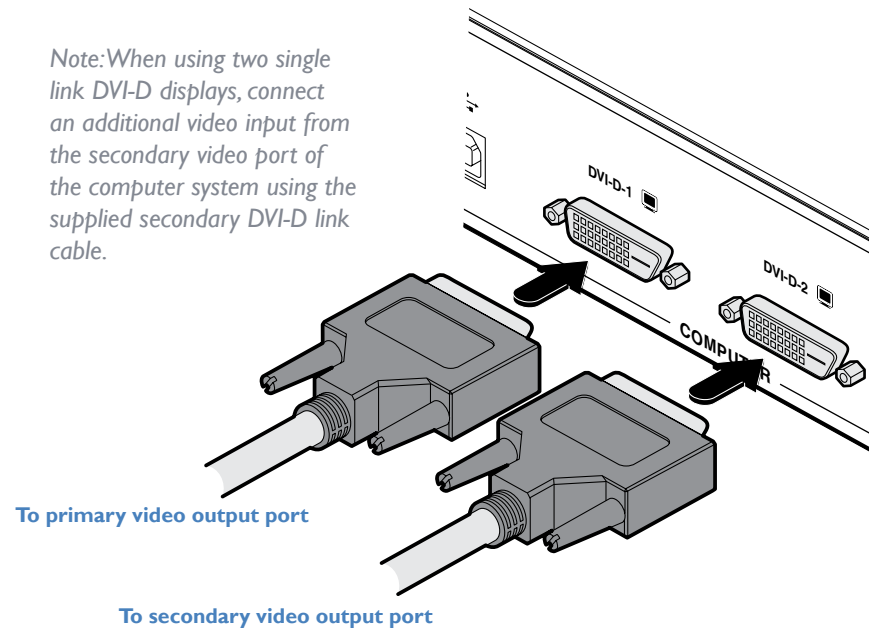

- 3 Connect the plug at the other end of the cable(s) to the corresponding DVI-D video output socket(s) of the host computer.

Audio links

ALIF dual units support two way stereo digital sound so that you can use a remote microphone as well as speakers.

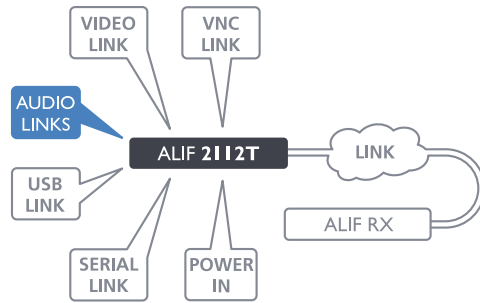

To make audio links

- 1 Connect an audio link cable between the **IN** socket on the TX unit rear panel and the speaker output socket of the host computer.

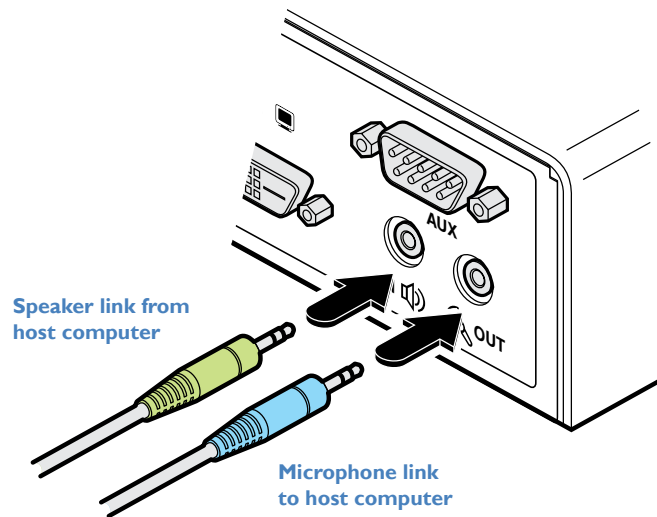

- 2 [Where a microphone is to be used]: Connect a second audio link cable between the **OUT** socket on the TX unit rear panel and the Line In socket of the host computer.

USB link

ALIF dual units act as USB 2.0 hubs and so can provide four sockets at the RX unit with only a single connection at the TX unit.

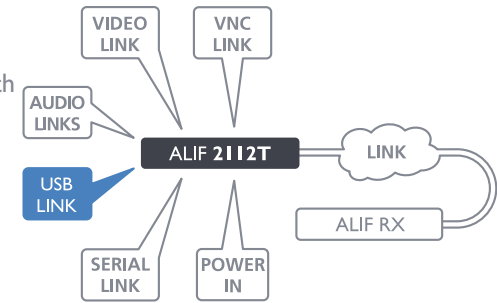

To make a USB link

- 1 Connect the type B connector of the supplied USB cable to the USB port on the TX unit rear panel.

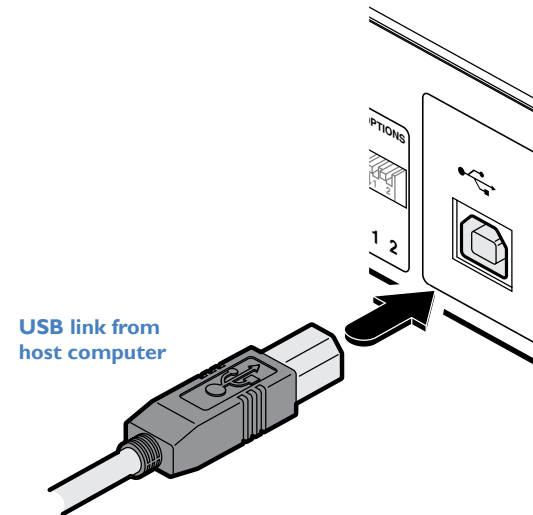

- 2 Connect the type A connector of the cable to a vacant USB socket on the host computer.

AUX port

The AUX port is an RS232 serial port that allows extension of RS232 signals up to a baud rate of 115200. The port has software flow control, but no hardware flow control.

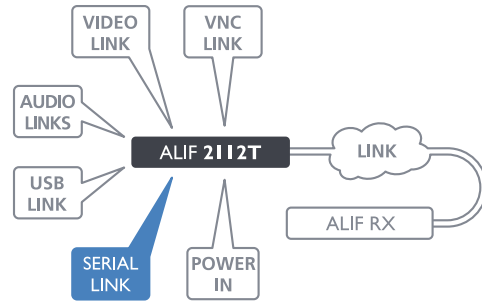

To connect the AUX port

- 1 Ensure that power is removed from the ALIF unit.
- 2 Connect a suitable serial 'null-modem' cable (see [Appendix M](#) for pin-out) between a vacant serial port on your computer and the AUX port on the right hand side of the ALIF dual rear panel.

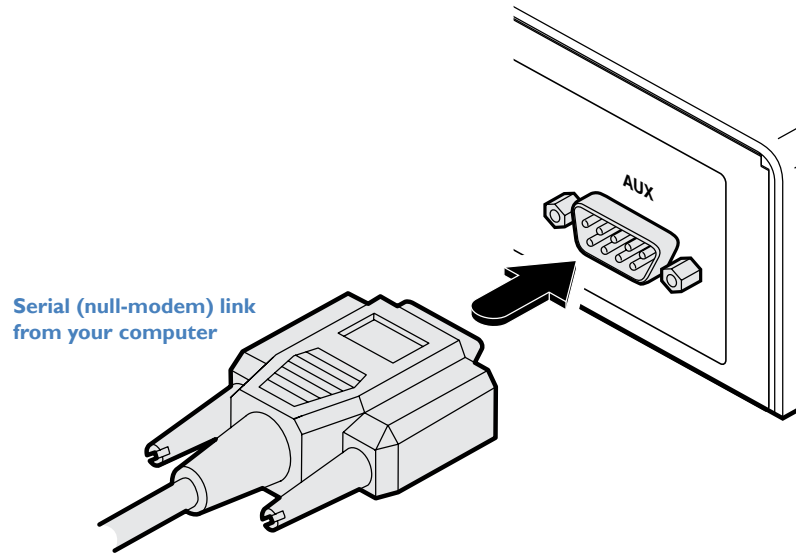

Power in

Each ALIF dual unit is supplied with a power adapter and country-specific power cord. When all other connections have been made, connect and switch on the power adapter unit.

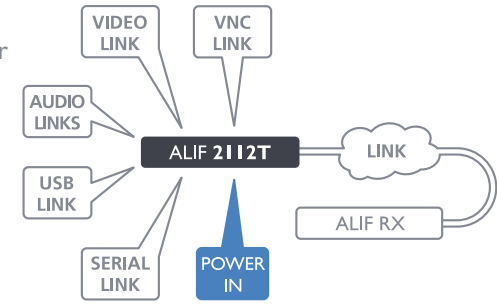

To apply power in

- 1 Attach the output lead from the power adapter to the 5V socket on the rear panel of the unit.

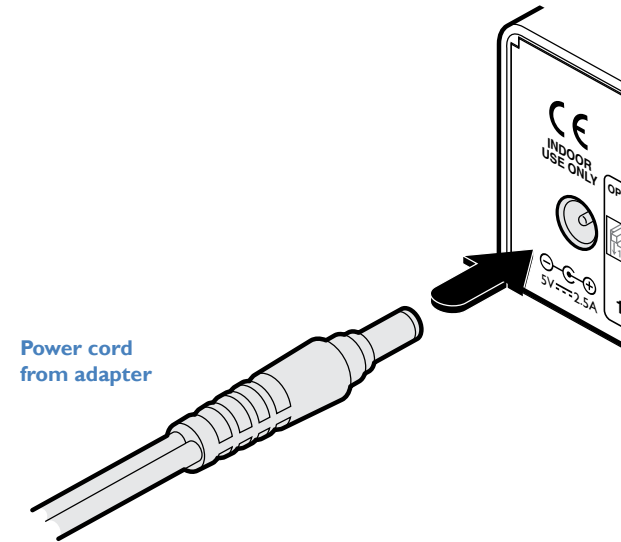

Note: Ensure that Options switches 1 and 2 are both in the 'OFF' (up) position to enable normal operation of the unit. See [Options switches](#) for details.

- 2 Connect the IEC connector of the supplied country-specific power cord to the socket of the power adapter.
- 3 Connect the power cord to a nearby main supply socket.

Note: Both the unit and its power supply generate heat when in operation and will become warm to the touch. Do not enclose them or place them in locations where air cannot circulate to cool the equipment. Do not operate the equipment in ambient temperatures exceeding 40°C. Do not place the products in contact with equipment whose surface temperature exceeds 40°C.

High speed links

ALIF dual (inc 2112T) units can be either connected directly to each other or via a high speed network. The connections can be copper-based Gigabit Ethernet as well as Fibre Channel over Ethernet (FCoE). These can be used in parallel to provide up to 2 Gigabit connections speeds.

A single System port (Gigabit Ethernet) is provided as standard on the right side of the front panel. Additionally, the Teaming port, located just to the left, allows you to insert either an optional Fibre Channel SFP module or Active Copper SFP module. The chosen module can then allow either a fibre optic or additional Gigabit Ethernet link to be used in parallel with the fixed System (Gigabit Ethernet) port.

To link ALIF dual units using the Teaming port

- 1 Insert the appropriate optional SFP module (SFP-MM-LC, SFP-SM-LC or SFP-CATX-RJ45) into the aperture on the ALIF dual front panel:

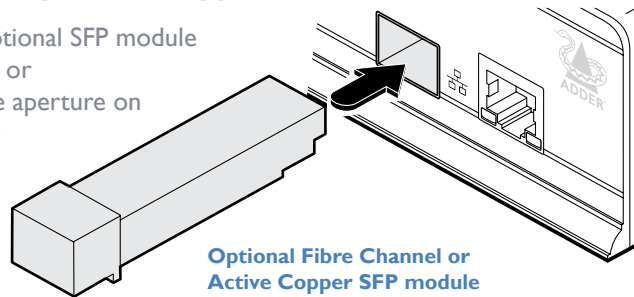

- 2 Make your connection(s) between the chosen SFP module and either the other ALIF dual unit or a suitable network switch:

Connect the transmit and receive fibre optic links to the sockets on the Fibre Channel SFP module. Then close the latch over the link connectors to lock them into place.

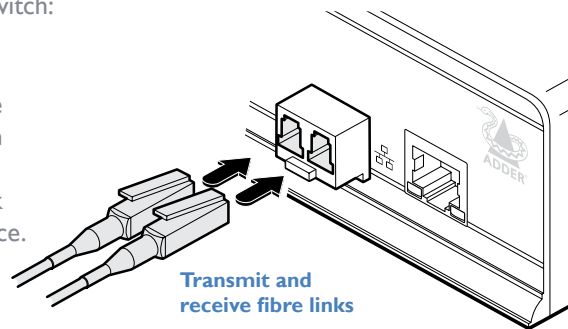

or

Connect a CAT 5, 5e, 6, or 7 cable to the socket on the Active Copper SFP module.

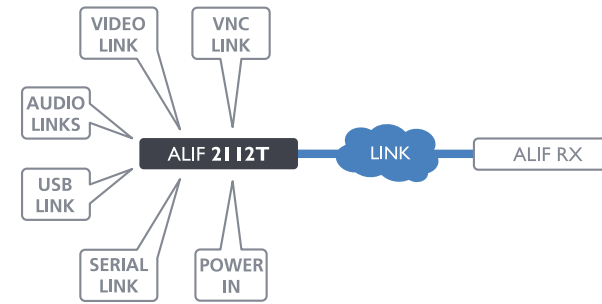
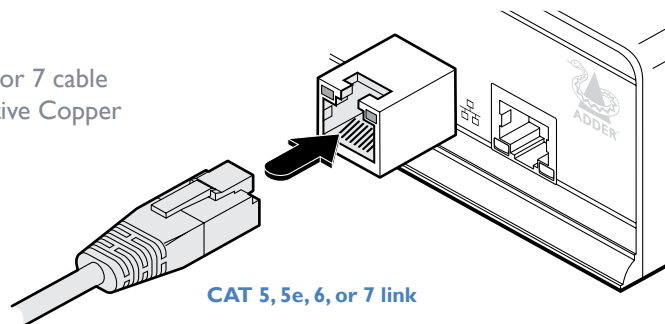

Please see [Appendix C](#) for important tips about networking ALIF units.

To link ALIF dual units using the System port

- 1 Connect a CAT 5, 5e, 6, or 7 cable to the System port socket on the front panel of the ALIF dual unit.

CAT 5, 5e, 6, or 7 link either directly from the other ALIF unit or from a Gigabit Ethernet switch

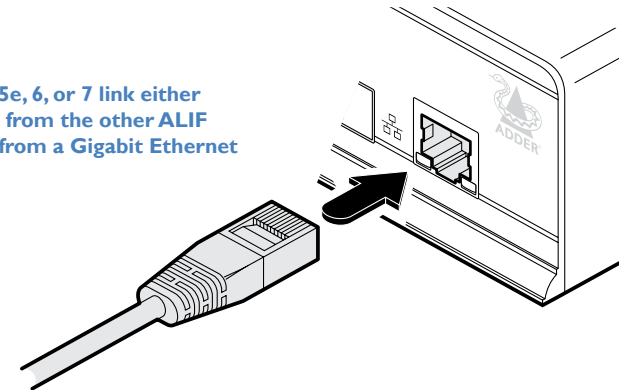

- 2 Connect the other end of the cable either to the other ALIF dual unit or to a Gigabit Ethernet switch, as appropriate.
- 3 [For connections via a network] repeat steps 1 and 2 for the other ALIF dual unit.

Cable and fibre details

- For direct links over Ethernet cable, the length of cable should not exceed 100 metres (328 feet). Network cables used for connections may be category 5, 5e, 6 or 7 twisted-pair cable. ALIF 2112T units have an autosensing capability on their network interfaces, so for direct point-to-point connections, no 'crossover' Ethernet cable is required.
- For direct links via fibre, varying distances can be achieved depending on the module and cable types used. Please refer to the table in [Appendix N](#) for detailed information. The fibre links must have crossovers.

Configuration

The ALIF 2112T unit consists of two distinct sections (as detailed below) which each have their own separate configuration procedures within this chapter.

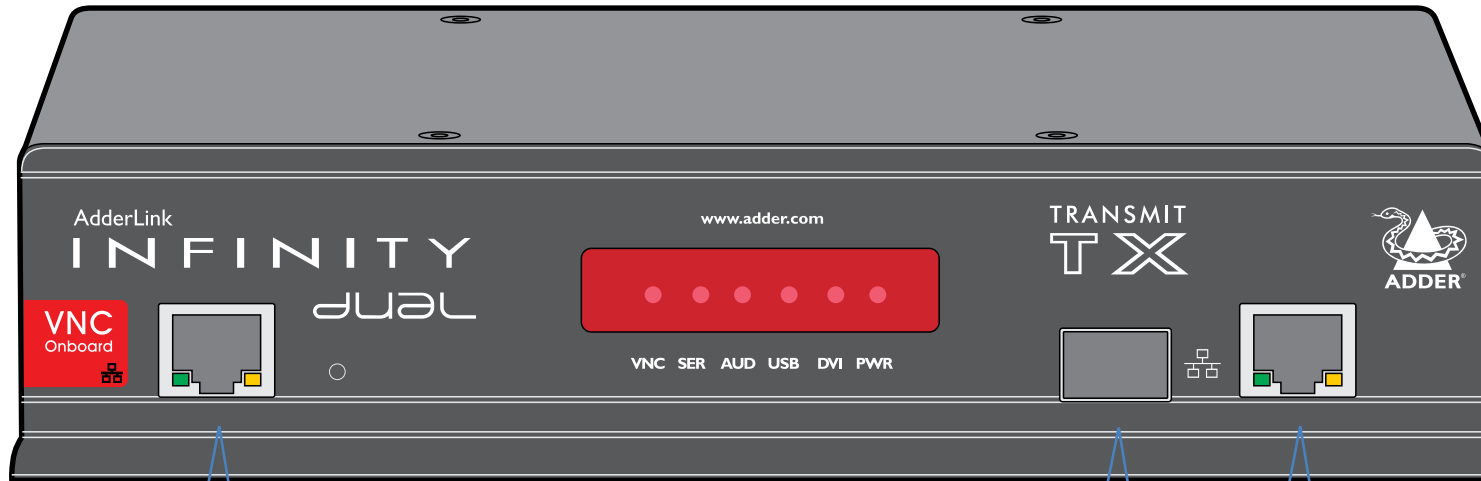

The VNC port

Uses the standard Ethernet port on the left side of the front panel and provides lower-bandwidth image video feeds for use across standard networks and the wider Internet.

Please see [Appendix B - The VNC port: Initial configuration for details.](#)

The System and Teaming ports

These use either the Gigabit Ethernet or (optional) Fibre Channel over Ethernet (FCoE) module, on the right side of the front panel and provide high resolution DVI-D image, audio and peripheral feeds.

Please see [page 14](#) for details.

SYSTEM AND TEAMING PORTS: INITIAL CONFIGURATION

ALIF 2112T units are designed to be as flexible as possible and this principle extends also to their configuration.

Direct linking

Where ALIF transmitters and receivers (all models) are directly linked to each other, very little configuration action is required, provided that they have their factory default settings in place. If the standard settings have been changed in a previous installation, you merely need to perform a factory reset on each unit.

Networked linking

Where ALIF transmitters and receivers (all models) are connected via networked links, you can either configure them individually, or configure them collectively using an A.I.M. server:

- **Configuring networked ALIF units individually** - You need to specify the network addresses of the ALIF units so that they can locate each other. This is done by running the [AdderLink Infinity browser-based configuration utility](#) on a computer system linked to the same network as the ALIF units.
- **Configuring ALIF units collectively** - The AdderLink Infinity Management (A.I.M.) server allows you to configure, control and coordinate any number of ALIF transmitters and receivers from a single application.

IMPORTANT: When using A.I.M. to configure ALIF dual units, it is vital that all units that you wish to locate and control are set to their factory default settings. Otherwise they will not be located by the A.I.M. server. If necessary, perform a factory reset on each ALIF dual unit.

Please also see [Appendix C - Tips for success when networking ALIF units](#)

Manual factory reset

A factory reset returns an ALIF transmitter or receiver unit to its default configuration. You can perform factory resets using the [AdderLink Infinity browser-based configuration utility](#) or by using this direct manual method.

To perform a manual factory reset

- 1 Remove power from the ALIF unit.
- 2 Use a narrow implement (e.g. a straightened-out paper clip) to press-and-hold the recessed reset button on the front panel. With the reset button still pressed, re-apply power to the unit and then release the reset button.

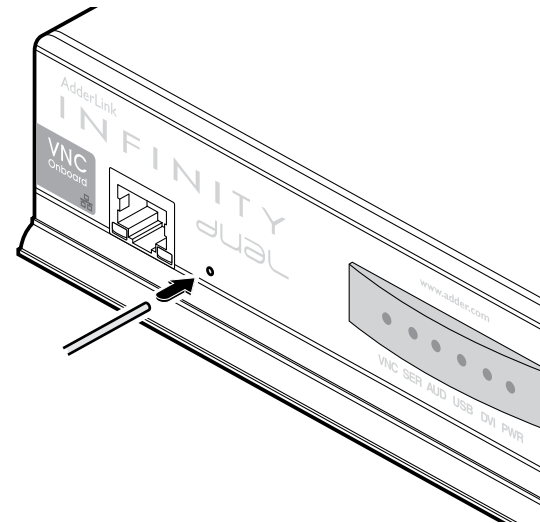

Use a straightened-out paper clip to press the reset button while powering on the unit

After roughly eight seconds, when the factory reset has completed, five of the front panel indicators will flash for a period of three seconds to indicate a successful reset operation.

AdderLink Infinity browser-based configuration utility

The browser-based configuration utility within all TX and RX units requires a network connection between the Gigabit Ethernet port of the ALIF 2112T unit and a computer on the same network. The configuration utility allows you to perform all of the following functions:

- View/edit the IP network address and netmask,
- Configure separate IP network addresses for video, audio and USB,
- Configure multicast settings (on RX units),
- Configure video bandwidth settings (on TX units),
- View the current video output (on TX units),
- Perform a firmware upgrade,
- Perform a factory reset,
- Enable/disable and configure the VNC network port settings.

To connect a computer system for browser-based configuration

- 1 Connect a suitable network cable to the Gigabit Ethernet port on the right side of the ALIF 2112T front panel.

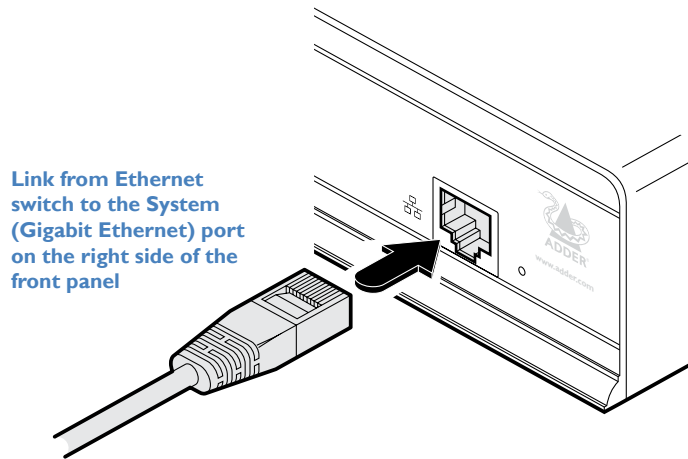

Note: It is also possible to gain access to the browser-based utility via the Teaming port.

- 2 Connect the other end of the link cable to your network.
- 3 Similarly, link your computer to the same network.
- 4 If not already switched on, power up your computer and the ALIF 2112T unit. You are now ready to use the browser-based configuration utility.

To access the browser-based configuration utility

- 1 Temporarily connect the ALIF 2112T unit and your computer, as discussed left.
- 2 Run a web browser on your computer and enter the IP address of the ALIF dual port that you are using.

The default settings are as follows:

	ALIF 2112T	RX units
System port	169.254.1.33	169.254.1.32
Teaming port	169.254.1.43	169.254.1.42

Note: Where the port addresses of a unit have been changed and are not known, providing it is appropriate to do so, perform a [manual factory reset](#) to restore the default addresses.

The opening page of the ALIF configuration utility should be displayed:

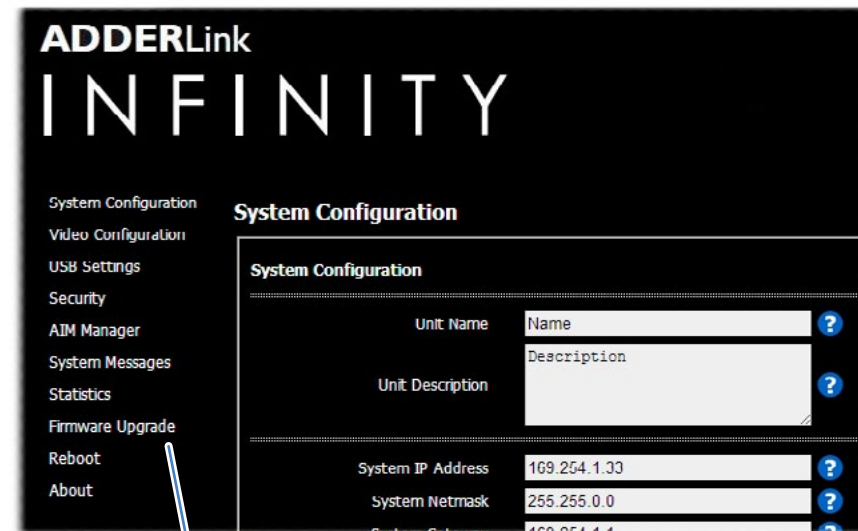

Use the menu options to choose the required configuration page

You can find further information about the configuration pages within the following appendix later in this guide:

- [Appendix A - Transmitter \(TX\) unit configuration pages](#)

A rough guide to configuring TX and RX units

TX (transmitter) unit configuration

In an ALIF dual system, the majority of configuration settings are dictated by the [RX units](#). Therefore, the local TX unit setup (using its browser-based configuration utility) is usually concerned only with three main factors: Its IP address details, the data streams to enable/disable and video signal optimization. Other TX unit pages, such as [USB Settings](#), [System Messages](#), [Firmware Upgrades](#) and [Reboot](#) are generally not used or altered during the majority of installations and are discussed elsewhere in this guide. See [Appendix A](#) for explanations of all TX configuration page options.

Setting the TX address and output signal details

- 1 Display the TX unit [System Configuration](#) page.
- 2 Ensure that the IP address and netmask for the System port and the Teaming port (if used) are correct. The default settings of 169.254.1.33 and 169.254.1.43 for the two ports respectively are their zero config addresses - these are usually changed to some other address suitable for your installation. Indeed, the zero config address for the System port MUST be changed before the Teaming port can be used for network connections.
- 3 Check that the data streams (Enable Video, Enable Audio and Enable USB - plus Enable Serial, if used) are enabled as appropriate. There are similar options within the RX unit configuration and it is important that the settings in both units are the same. If an option is ticked in one unit but unticked in the other, then that data stream will remain disabled. If you make a change, remember to click the **Update Now** button.

Optimizing the TX video signal

Note: Where the ALIF dual system is linked via two Gigabit links with sufficient available bandwidth, there should be no need to alter the default settings on this page.

- 1 Display the TX unit [System Configuration](#) page and then change to the Video Configuration page.
- 2 Make changes to the controls as necessary for each video port. There is no single combination of adjustments that will suit all installations, but generally:
 - If color quality is important, then leave *Colour Depth* at 24 bits and adjust other controls,
 - If moving video images are being shown frequently, then leave *Frame Skipping* at a low percentage and instead reduce the *Peak Bandwidth Limiter* and *Colour Depth*.
 - Where screens are quite static, try increasing the *Background Refresh* interval and/or increasing the *Frame skipping percentage* setting.

Make changes one at a time, in small steps, and view typical video images so that you can attribute positive or negative results to the appropriate control.

See [Video Configuration](#) for individual explanations of the controls.
- 3 Click **Update Now** to apply each setting change.

RX (receiver) unit configuration

In an ALIF dual system, it is the RX unit (receiver) that determines where and how data signals are sent (and received) by the [TX unit](#). Although numerous topologies (one-to-one, one-to-many, many-to-one, etc.) are made possible by the ALIF system, they are all dependent on two underlying modes of operation: either *Unicast* or *Multicast* transmission. Where multicast transmission is not invoked for video and/or audio data, operation will be automatically served by unicast network transmission technologies.

The RX unit setup (using the System Configuration page of its browser-based configuration utility) is concerned with four main factors: its own IP address(es), the data streams to enable/disable, the IP address(es) of the TX unit and multicast transmission details. Other pages, such as USB Settings, System Messages, Firmware Upgrades and Reboot are generally not used or altered during the majority of installations. For further details about RX unit configuration pages, please see the AdderLink Infinity dual guide.

Configuring the RX unit

- 1 Display the RX unit System Configuration page.
- 2 In the System Configuration section, ensure that the IP address and Netmask settings for the System and Teaming ports for this RX unit are correct. The default settings of 169.254.1.32 and 169.254.1.42 for the two ports respectively are their zero config addresses - these are usually changed to some other address suitable for your installation. Indeed, the zero config address for the System port **MUST** be changed before the Teaming port can be used. Enter the new values and click the **Update Now** button. The System IP Address that is set here will be sent to the TX unit as the destination for transmitted data (when operating in unicast mode). The Gateway entry is only necessary when the TX unit is located on a separate network to the RX unit.
- 3 Check that the data streams (Enable Video, Enable Audio and Enable USB - plus Enable Serial, if used) are enabled (ticked) or disabled (unticked) as appropriate. There are similar options within the TX unit configuration; if one of these options is ticked in one unit but unticked in the other, then that data stream will remain disabled. If you make a change, click the **Update Now** button.
- 4 If necessary, alter the Audio Input Type to match your audio input. The *line* option is for a stereo line input, *mic* and *mic boost* are for mono microphones, the latter benefiting from a +20dB gain boost.

continued

ADDERLink INFINITY RECEIVER (dual) System Configuration

System Configuration

- System Configuration
- USB Settings
- Security
- AIM Manager
- System Messages
- Statistics
- Firmware Upgrade
- Reboot
- About

System Configuration

System Configuration

Unit Name	ALIF2000R	?
Unit Description	AdderLink Infinity 2000R	?
System IP Address	169.254.1.32	?
System Netmask	255.255.0.0	?
System Gateway	169.254.1.1	?
Enable Management Port	<input checked="" type="checkbox"/>	?
Management Port IP Address	192.168.1.42	?
Management Port Netmask	255.255.0.0	?
Management Port Gateway	192.168.1.1	?
Enable Teaming Port	<input checked="" type="checkbox"/>	?
Teaming Port IP Address	169.254.1.42	?
Teaming Port Netmask	255.255.0.0	?
Teaming Port Gateway	169.254.1.1	?
Enable DVI-D-1	<input checked="" type="checkbox"/>	?
Enable DVI-D-2	<input checked="" type="checkbox"/>	?
Enable Audio	<input checked="" type="checkbox"/>	?
Enable USB	<input checked="" type="checkbox"/>	?
Enable Serial	<input checked="" type="checkbox"/>	?
Enable OSD Alerts	<input checked="" type="checkbox"/>	?
Keyboard Country Code	gb - UK	?
Audio Input Type	<input type="radio"/> mic <input checked="" type="radio"/> mic boost	?
Enable Video Compatibility Check for DVI-D-1	<input type="checkbox"/>	?
Enable Video Compatibility Check for DVI-D-2	<input type="checkbox"/>	?
	Identify Unit (short)	?
	Identify Unit (long)	?
	Update Now	

5 In the Target Transmitter Unit Settings section, you need to enter the System port and Teaming port IP addresses for the TX unit that will be supplying the video, audio, USB and serial data streams. This section allows you to determine which peripherals should use the second link. Most often all streams are supplied by the same TX unit, so common System and Teaming port addresses can be applied to all streams. However, it is possible to receive them from different locations, in which case, click the blue arrow to reveal the separate video, audio, USB and serial addresses. For all five peripherals, the System port of the targeted TX unit is always used to carry the respective data streams; your choices involve which of those five should also use the secondary Teaming port link to spread the load(s). For each peripheral, the first IP address is that of the targeted TX unit's System port. IP Address 2 corresponds to the Teaming port and is used only when the checkbox above is ticked. The default settings for all entries are the standard IP addresses that are factory set within every TX unit (169.254.1.33 and 169.254.1.43). Change these to the appropriate addresses on your transmitter(s) and click the **Update Now** button to save and activate them.

Target Transmitter Unit Settings	
IP Address for DVI-D-1	169.254.1.33
Use Teaming Port for DVI-D-1	<input checked="" type="checkbox"/>
IP Address 2 for DVI-D-1	169.254.1.43
Video No. for DVI-D-1	DVI-D-1
IP Address for DVI-D-2	169.254.1.33
Use Teaming Port for DVI-D-2	<input checked="" type="checkbox"/>
IP Address 2 for DVI-D-2	169.254.1.43
Video No. for DVI-D-2	DVI-D-2
Audio IP Address	169.254.1.33
Use Teaming Port for Audio	<input checked="" type="checkbox"/>
Audio IP Address 2	169.254.1.43
USB IP Address	169.254.1.33
Use Teaming Port for USB	<input checked="" type="checkbox"/>
USB IP Address 2	169.254.1.43
Serial IP Address	169.254.1.33
Use Teaming Port for Serial	<input checked="" type="checkbox"/>
Serial IP Address 2	169.254.1.43
Update Now	

6 For installations that will include more than one RX unit, for either video or audio or both, then you need to configure the *Multicast Settings* section.

Multicast Settings	
Enable Multicast DVI-D-1	<input checked="" type="checkbox"/>
Multicast DVI-D-1 Address	
Multicast DVI-D-1 Address 2	
Enable Multicast DVI-D-2	<input checked="" type="checkbox"/>
Multicast DVI-D-2 Address	
Multicast DVI-D-2 Address 2	
Enable Multicast Audio	<input checked="" type="checkbox"/>
Multicast Audio Address	
Multicast Audio Address 2	

The two Video and the single Audio Multicast sub-sections are configured in exactly the same way:

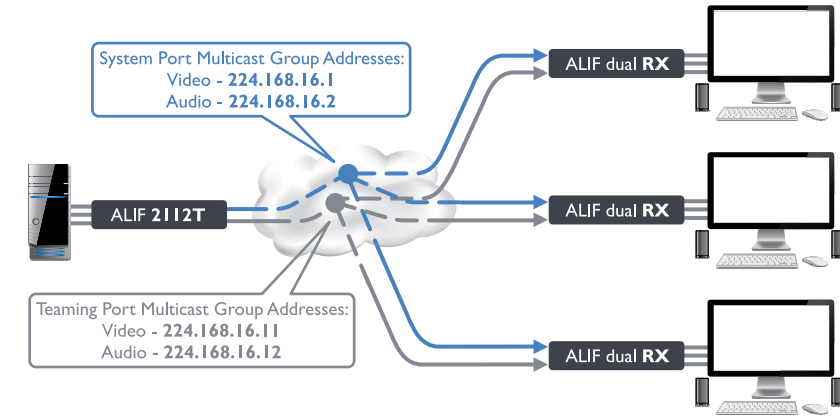

- First, tick the Enable Multicast Video / Enable Multicast Audio check box.
- Next, enter appropriate Multicast Addresses for the System port Video/ Audio data stream(s). The set of IP addresses between 224.0.0.0 and 239.255.255.255 are specifically reserved for multicast operations. Within a private enterprise network, you merely need to choose a location that is currently unused. However, if your link will pass through public networks, then attention must be given to finding an address within these limits that is not already reserved for special use. The IANA (Internet Assigned Numbers Authority) website: iana.org provides a list of publicly reserved addresses.
- Next, enter appropriate Multicast Address 2 entries for the Teaming port Video/Audio data stream(s).
The video and audio multicast addresses must be different, as must the System and Teaming ports. The addresses that you enter will be used by the RX unit to 'listen-in' on the video and audio data streams output by the TX unit. The same IP addresses need to be set on every RX unit that will similarly receive the video and audio data streams.

7 Click the **Update Now** button to save.

Repeat the IP addressing and multicast configuration steps for all RX units that will be part of the one-to-many installation.

For most installations, the successful implementation of these configuration steps will result in a correctly working system.

PERFORMING AN UPGRADE

ALIF 2112T units are flash upgradeable using the method outlined here. However, for larger installations we recommend that you use the AdderLink Infinity Manager (A.I.M.) to upgrade multiple ALIF dual units. When using the method below, the ALIF dual unit will be upgraded in sequence.

WARNING: During the upgrade process, ensure that power is not interrupted as this may leave the unit in an inoperable state.

If the upgrade process is interrupted and fails, it may be necessary to switch to the backup firmware image in order to regain operation. See right for details.

To upgrade a single unit via network link

- 1 Download the latest upgrade file from the Adder Technology website.
Note: There are separate upgrade files for TX and RX units.
- 2 Temporarily connect the ALIF 2112T unit and a computer via a network (see [AdderLink Infinity browser-based configuration utility](#) section for details).
- 3 Run a web browser on your computer and enter the IP address of the ALIF 2112T unit to be upgraded.
- 4 Click the Firmware Upgrade link. Within the Firmware Upgrade page, click the Choose File button. In the subsequent file dialog, locate the downloaded upgrade file - check that the file is correct for the unit being upgraded.
- 5 Click the Upgrade Now button. A progress bar will be displayed (however, if your screen is connected to the unit being upgraded then video may be interrupted) and the indicators on the front panel will flash while the upgrade is in progress.
- 6 The indicators should stop flashing in less than one minute, after which the unit will automatically reboot itself. The upgrade process is complete.

Finding the latest upgrade files

Firmware files for the ALIF dual units are available from the *Technical Support > Updates* section of the Adder Technology website (www.adder.com).

Note: It is possible to downgrade a version 3.0 AdderLink Infinity 2112T unit to an earlier firmware version that lacks the Teaming facility. After installing the older firmware, perform a factory reset on each AdderLink Infinity 2112T in order to clear the Teaming port configuration file.

OPTIONS SWITCHES

A pair of Options switches are located on the rear panel of every ALIF 2112T unit.

Switch 1 - firmware image select

Each ALIF 2112T unit retains a backup firmware image which can be used in situations where the primary firmware becomes corrupted (most often through failed upgrade operations). Using the backup firmware will allow you to regain operation of the unit.

Option switch 1	OFF	Normal operation using the main firmware
	ON	Operate using the backup firmware image

Option switch 2 is reserved and must remain in the OFF (up) position for normal operation.

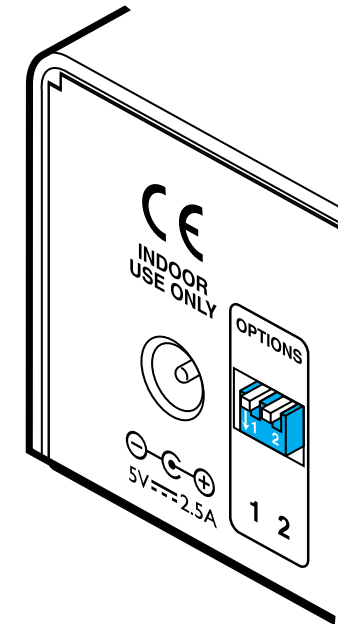

In operation, many ALIF dual installations require no intervention once configured. The TX and RX units take care of all connection control behind the scenes so that you can continue to work unhindered.

FRONT PANEL INDICATORS

The six front panel indicators on each unit provide a useful guide to operation:

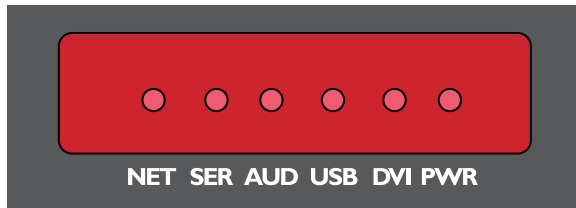

Indicators

These six indicators clearly show the key aspects of operation:

- **NET** On when valid network link is present. Flashes when the unit is in error.
- **SER** On when the AUX (serial) port is enabled and active.
- **AUD** On when audio is enabled and active.
- **USB** On when USB is enabled and active.
- **DVI** On when the DVI Video channel is enabled.
- **PWR** Power indicator.

USING THE VNC VIEWER

1 On a network connected computer, locate and select the VNC viewer icon ⇨



A connection details dialog will be displayed:

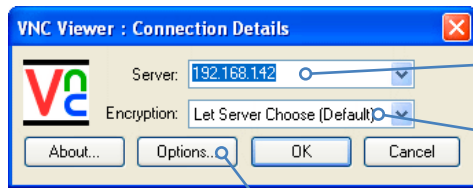

Enter the ALIF 21 I2T address here and click OK

If required, select the encryption mode

Options button

Provides a range of viewer and connection settings - [MORE \[+\]](#)

2 In the 'Server:' entry, type the network address that has been configured for the VNC port of the ALIF 21 I2T unit.

3 Click the OK button. The viewer window may open straight away or the system may require user authentication, in which case an authentication dialog will be displayed:

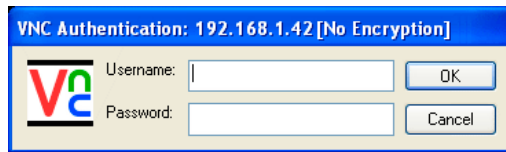

4 Enter your Username and Password and click the OK button. The viewer window should now open ⇨

Viewer options
(VNC viewer only) Click the VNC icon to view the viewer window options.

Ctrl Alt Del
Sends the Ctrl Alt Del sequence to the current host computer.

Controls
Displays a menu of options concerning keyboard, video and mouse operation.

Power
Click to access the power on/off options for the current host computer.

Dialog area
Indicates your username and the host system that you are currently viewing. This area can also display other messages.

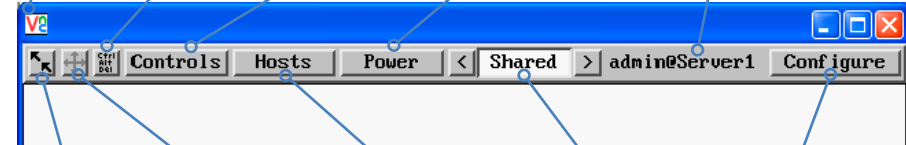

Re-sync mouse
Ensures that the mouse pointer which you move and the mouse pointer on the host system are correctly synchronized.

Auto calibrate
This button will calibrate the mouse, but only when relative mouse mode is selected.

Hosts
Click to display a list of computers. Choose an entry to connect to that host computer.

Access mode
Allows you to choose between Shared and Private access modes.

Configure
This option is only available to the admin user and provides access to the main configuration menus.

When using the viewer window

What is the best screen resolution to use?

The best resolution for your computer is one that is larger than the screen of the host computer that you are viewing. This will allow you to see everything without scrolling around. Alternatively, the VNC viewer can be set to scale the image to fit your screen, but remember that some pixel dithering effect will be seen when scaling is used.

How do I navigate around a larger screen?

If the screen that you are viewing has a larger resolution than your viewing window you will need to scroll around to see all items. The viewer window allows you to 'bump scroll' (only in full screen mode). This means that when your mouse cursor bumps against the edge of the screen, the screen image will scroll across automatically.

How do I escape from full screen mode?

Press the F8 button. This button is changeable but is most often set to F8.

How do I make the most of a slow connection?

The VNC viewer is slightly better suited to slower connections than the browser viewer because it offers more options. Click the [Options](#) button of the VNC viewer when entering the ALIF 21 I2T address during log on.

Rate limit mouse events

When selected, this mode greatly reduces the mouse movement data that are sent to the host computer. When you move the local mouse, the remote cursor will catch up roughly once per second.

This chapter contains a variety of information, including the following:

- Getting assistance - see right
- [Appendix A - Transmitter \(TX\) unit configuration pages](#)
- [Appendix B - The VNC port: Initial configuration](#)
- [Appendix C - Tips for success when networking ALIF units](#)
- [Appendix D - Troubleshooting](#)
- [Appendix E - Glossary](#)
- [Appendix F - Configuration menus \(via VNC\)](#)
- [Appendix G - VNC viewer connection options](#)
- [Appendix H - VNC viewer window options](#)
- [Appendix I - Java viewer options](#)
- [Appendix J - The KVMADMIN utility](#)
- [Appendix K - Known working video modes](#)
- [Appendix L - Hotkey sequences](#)
- [Appendix M - Cable pinouts, video modes and general specifications](#)
- [Appendix N - Fibre modules and cables](#)
- [Appendix O - Additional features](#)
- [Safety information](#)
- [Warranty](#)
- [Radio frequency energy statements](#)

GETTING ASSISTANCE

If you are still experiencing problems after checking the information contained within this guide, then we provide a number of other solutions:

- **Online solutions and updates** – www.adder.com/support
Check the Support section of the adder.com website for the latest solutions and firmware updates.
- **Adder Forum** – forum.adder.com
Use our forum to access FAQs and discussions.
- **Technical support** – www.adder.com/contact-support-form
For technical support, use the contact form in the Support section of the adder.com website - your regional office will then get in contact with you.

APPENDIX A - Transmitter (TX) unit configuration pages

This section covers the browser-based configuration utility for the AdderLink Infinity TX (transmitter) unit. The TX utility has ten pages, titled as follows:

- [System Configuration](#)
- [Video Configuration](#)
- [USB Settings](#)
- [Security](#)
- [AIM Manager](#)
- [System Messages](#)
- [Statistics](#)
- [Firmware Upgrade](#)
- [Reboot](#)
- [About](#)

ADDERLink
TRANSMIT (dual)
System Configuration

- System Configuration
- Video Configuration
- USB Settings
- Security
- AIM Manager
- System Messages
- Statistics
- Firmware Upgrade
- Reboot
- About

System Configuration

System Configuration

Unit Name	Name <input type="text"/>	?
Unit Description	Description <input type="text"/>	?

System IP Address	<input type="text" value="169.254.1.33"/>	?
System Netmask	<input type="text" value="255.255.0.0"/>	?
System Gateway	<input type="text" value="169.254.1.1"/>	?

Enable VNC Port	<input checked="" type="checkbox"/>	?
VNC Port IP Address	<input type="text" value="192.168.1.42"/>	?
VNC Port Netmask	<input type="text" value="255.255.0.0"/>	?
VNC Port Gateway	<input type="text" value="192.168.1.1"/>	?

Enable Teaming Port	<input checked="" type="checkbox"/>	?
Teaming Port IP Address	<input type="text" value="169.254.1.43"/>	?
Teaming Port Netmask	<input type="text" value="255.255.0.0"/>	?
Teaming Port Gateway	<input type="text" value="169.254.1.1"/>	?

Enable DVI D-1	<input checked="" type="checkbox"/>	?
Enable DVI-D-2	<input checked="" type="checkbox"/>	?
Enable Audio	<input checked="" type="checkbox"/>	?
Enable USB	<input checked="" type="checkbox"/>	?
Enable Serial	<input checked="" type="checkbox"/>	?
Serial Baud Rate	<input type="text" value="115200"/>	?
Serial Data Bits	<input type="text" value="8"/>	?
Serial Stop Bits	<input type="text" value="1"/>	?
Serial Parity	<input type="text" value="None"/>	?

?
 ?

Thumbnails

Image last updated : Wed Sep 25 2013 10:26:35 GMT+0100 (GMT Daylight Time) (Browser Time)

DVI-D-1

2560x1440@60Hz * 24bpp DVI

Unit Name

Name details that you can alter to distinguish this unit from all others. The name entered here will be read by A.I.M. units (if used) for administration purposes.

Unit Description

Allows you to optionally add a description of the unit, such as its location. Useful when many ALIF units are being used.

System port

This section determines the IP address, netmask and gateway details for the main Gigabit Ethernet port located on the right side of the front panel. The default IP address is 169.254.1.33 which is the zero config IP address that allows the unit to work immediately in point-to-point mode. You are recommended to change this to an appropriate address in the private IP range 192.168.xxx.xxx

The default netmask is 255.255.0.0. If you change the IP address to the private range, you are recommended to change this to 255.255.255.0. The default gateway address is 169.254.1.1

VNC port

Determines whether the port on the left side of the front panel is enabled and which IP address details it should use. The default IP address is 192.168.1.42.

Teaming port

Determines whether the SFP socket on the right side of the front panel is enabled and which IP address details it should use. The default IP address is 169.254.1.43 which is the zero config IP address that allows the unit to work immediately in point-to-point mode. You are recommended to change this to an appropriate address in the private IP range 192.168.xxx.xxx. The default netmask is 255.255.0.0. If you change the IP address to the private range, you are recommended to change this to 255.255.255.0

The default gateway address is 169.254.1.1. *Note: Before the Teaming port can be used for connection via a network, you need to ensure that the System port has been configured away from its zero config IP address.*

Enable options

These checkboxes allow you to determine which peripheral options will be used: Video, audio, USB and serial.

Serial port options

These allow you to match the serial configuration being used by the attached PC host.

Identify unit

When clicked, these buttons cause the front panel indicators to flash to assist with identifying the ALIF unit within a rack.

- The Identify Unit (short) button flashes the indicators for five seconds.
- The Identify Unit (long) button flashes the indicators for one hour but can be overridden by clicking the Identify Unit (short) button.

Thumbnail

The Thumbnail shows snap shots of the video feeds that are connected and reports the video resolutions/color depths that have been detected. Click the Refresh Thumbnail button to update.

To get here

- 1 [Connect your computer to the Management port](#) on the left side of the front panel.
- 2 Run a web browser and enter the IP address of the Management port:
http://192.168.1.42
If the address is unknown, perform a [manual factory reset](#).
- 3 If necessary, click the **System Configuration** link.

INSTALLATION

CONFIGURATION

OPERATION

FURTHER INFORMATION

INDEX

24

ADDERLink
TRANSMIT (dual)
Video Configuration

- System Configuration
- Video Configuration**
- USB Settings
- Security
- AIM Manager
- System Messages
- Statistics
- Firmware Upgrade
- Reboot
- About

Video Configuration

Bandwidth Control for Video 1 and Video 2

Peak bandwidth limiter percentage: 95
 1 95 ?

DVI-D-1 Control

Background Refresh: every 32 frames ?

Colour Depth: 24 bit ?

Enable Magic Eye: ?

Use Default DDC: ?

Choose Default DDC: GENERIC 4:3 ?

Enable Hot Plug Detect on change of display: ?

Period of Hot Plug Detect signal: Default - 25ms ?

Frame skipping percentage: 0
 0 99 ?

DVI-D-2 Control

Background Refresh: every 32 frames ?

Colour Depth: 24 bit ?

Enable Magic Eye: ?

Use Default DDC: ?

Choose Default DDC: GENERIC 4:3 ?

Enable Hot Plug Detect on change of display: ?

Period of Hot Plug Detect signal: Default - 25ms ?

Frame skipping percentage: 0
 0 99 ?

[Update Now](#)

Peak bandwidth limiter percentage

The TX unit will employ a 'best effort' strategy in sending video and other data over the IP network. This means it will use as much of the available network bandwidth as necessary to achieve optimal data quality, although typically the TX unit will use considerably less than the maximum available. In order to prevent the TX unit from 'hogging' too much of the network capacity, you can reduce this setting to place a tighter limit on the maximum bandwidth permissible to the TX unit. Range: 0 to 95%.

Note: All of the following controls are available separately for each video port:

Background Refresh

The TX unit sends portions of the video image only when they change. In order to give the best user experience, the TX unit also sends the whole video image, at a lower frame rate, in the background. The Background Refresh parameter controls the rate at which this background image is sent. The default value is 'every 32 frames', meaning that a full frame is sent in the background every 32 frames. Reducing this to 'every 64 frames' or more will reduce the amount of bandwidth that the TX unit consumes. On a high-traffic network this parameter should be reduced in this way to improve overall system performance. Options: every 32 frames, every 64 frames, every 128 frames, every 256 frames or disabled.

Colour Depth

This parameter determines the number of bits required to define the color of every pixel. The maximum (and default) value is '24 bit'. By reducing the value you can significantly reduce bandwidth consumption, at the cost of video color reproduction. Options: 24 bit, 16 bit or 8 bit.

Enable Magic Eye

This feature, enabled as standard, aims to reduce the effect of dithering - a technique used by some graphics cards to improve the perceived quality and color depth of images by diffusing or altering the color of pixels between video frames. The Magic Eye feature increases the frame rate and eliminates unnecessary network traffic by ignoring the color dithering where it occurs. If the video source is not noisy or dithered then you can switch off Magic Eye to enable full color accuracy.

Use Default DDC and Choose Default DDC

When the *Use Default DDC* option is unticked, AdderLink Infinity will use the EDID that is reported by the monitor connected to the receiver unit. However, if you tick the *Use Default DDC* option, you can then select from a range of preset video resolutions from the *Choose Default DDC* drop down box. Once selected, the TX will report itself capable of only supporting this one video resolution. Please note that all of the listed video resolutions are single link DVI with a maximum pixel clock of 165MHz and a 60Hz refresh rate.

Enable Hot Plug Detect...

When this option is ticked, every time the monitor is changed at the receiver unit, a hot plug detect message will be sent to the graphics card of the PC attached to the TX unit.

Period of Hot Plug Detect signal

This is the length of time that a hot-plug detect signal is applied. The default of 25mS is sufficient for the majority of graphics cards, however, a small minority may need to be given a longer a period.

Frame skipping percentage

Frame Skipping involves 'missing out' video frames between those captured by the TX unit. For video sources that update only infrequently or for those that update very frequently but where high fidelity is not required, frame skipping is a good strategy for reducing the overall bandwidth consumed by the system. Range: 0 to 100%.

To get here

- 1 [Connect your computer to the Management port](#) on the left side of the front panel.
- 2 Run a web browser and enter the IP address of the Management port: **http://192.168.1.42**
If the address is unknown, perform a [manual factory reset](#).
- 3 If necessary, click the **Video Configuration** link.

TX USB Settings

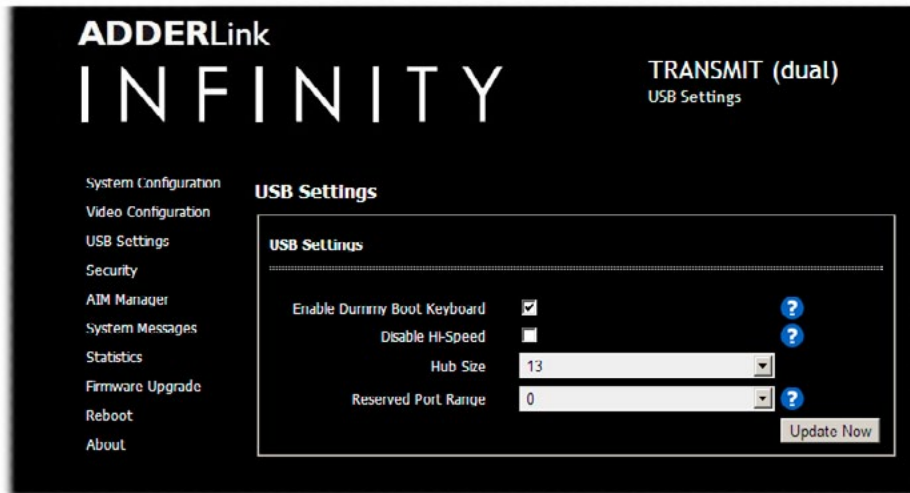

Enable Dummy Boot Keyboard

When ticked, the TX unit reports a virtual dummy boot keyboard to the attached PC to ensure that a keyboard is always reported when the PC boots up. The dummy boot keyboard uses one of the 13 USB endpoints, therefore if all 13 endpoints are required elsewhere for USB devices (or a KVM switch only supports two HID devices) then it can be disabled by deselecting this option. See also *Reserved Port Range* below.

Disable Hi-Speed

This option allows you to force the system to run at the low/full USB speed of 12Mb/s, thus forcing USB 2.0 Hi-Speed devices to adapt to the lower rate.

Hub Size

Using this option you can select whether the transmitter should report itself as a 13 or a 7 port USB hub. Some USB hosts are only able to support 7 port USB hubs. If this option is set to 7, then only 7 USB devices are supported by the PC.

Reserved Port Range

For some devices, e.g. touch screens, you may wish to ensure that they are always reported to the same USB port number so that the USB driver will always find the device. This option allows you reserve up to 8 ports for certain devices. At the RX unit, the devices are assigned to the reserved ports. If a port reservation is to be applied, then the dummy boot keyboard should be disabled. The default value for this option is '0', i.e. *disabled*. See *Port Reservation* on the RX unit for further details.

TX Security

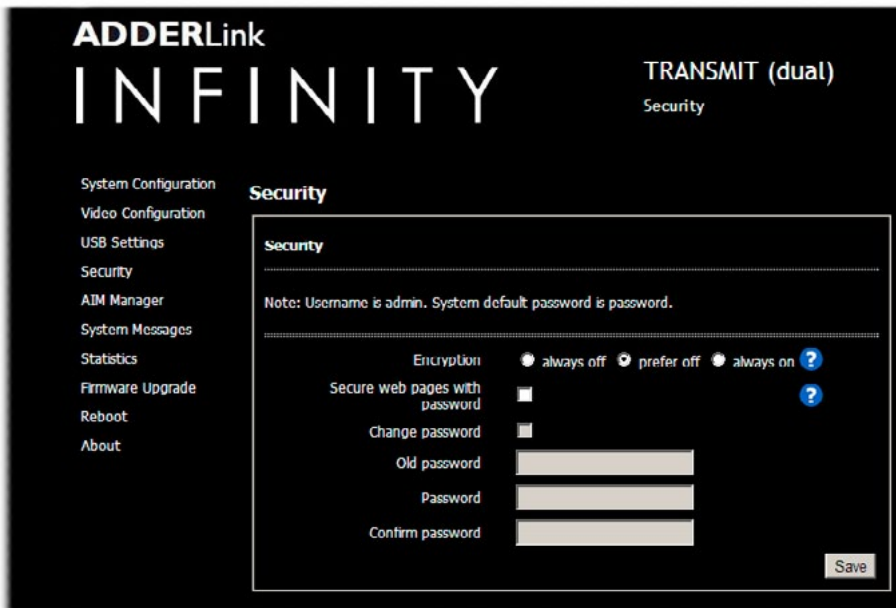

Encryption

This setting allows you to apply encryption to the USB and control data passed across the link. Note that video data is never encrypted.

Secure Web pages with password

When ticked, this option enables https security so that the configuration pages are only accessible to the admin user with a password.

Change/confirm password

These options allow you to change the admin password for the system.

To get here

- 1 [Connect your computer to the Management port](#) on the left side of the front panel.
- 2 Run a web browser and enter the IP address of the Management port: **http://192.168.1.42**
If the address is unknown, perform a [manual factory reset](#).
- 3 Click either the **USB Settings** or **Security** links, as appropriate.

TX AIM Manager

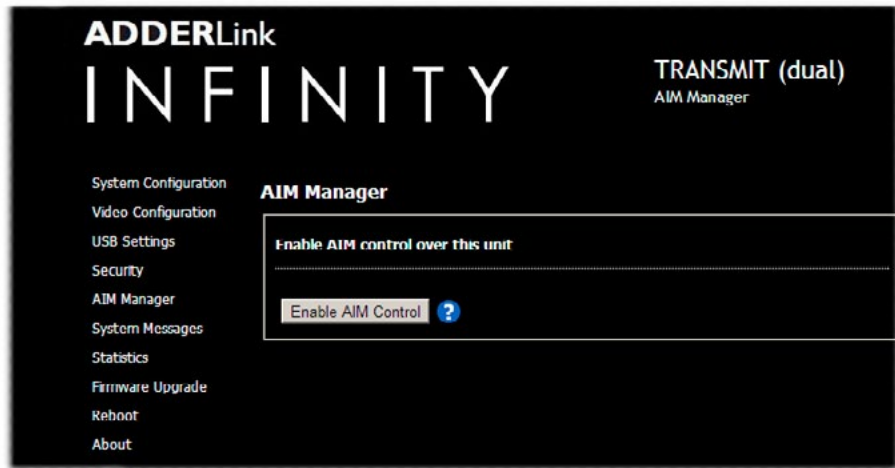

TX System Messages

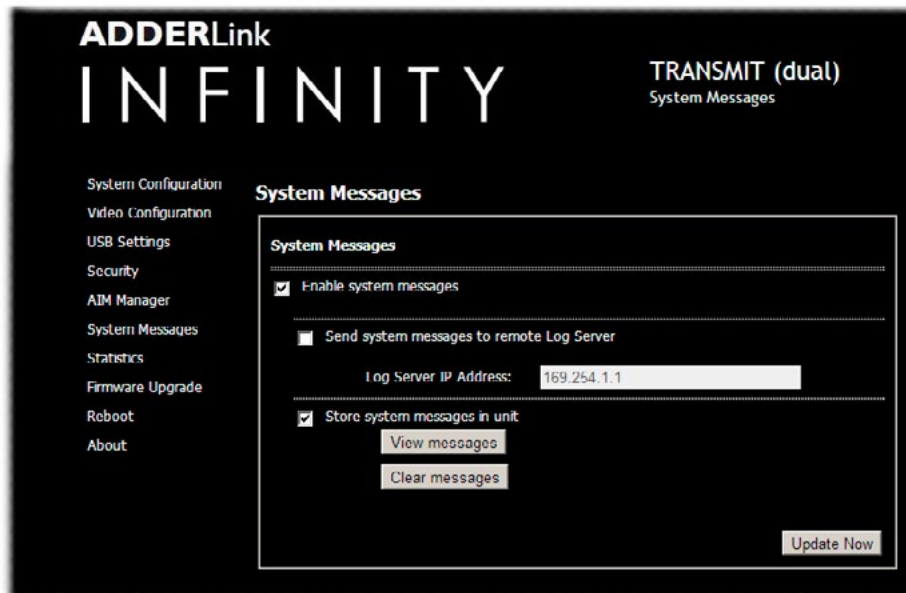

Enable AIM Control

Click this button to allow an A.I.M. (Adder Infinity Manager) box to take control of this TX. When the button is clicked, the TX unit will be rebooted to allow the A.I.M. box to discover and control it.

Enable system messages

Tick to allow the creation of status and error messages by the unit.

Send system messages to remote Log Server

Choose this option to send the system messages to a remote server via the network. Provide the IP address of a suitable server here also.

Store system messages in unit

When ticked, this option will store system messages within the memory of the unit. Click the *View messages* button to view the list or the *Clear messages* button to delete the list.

Update Now

Click to save and implement any changes that you make.

To get here

- 1 [Connect your computer to the Management port](#) on the left side of the front panel.
- 2 Run a web browser and enter the IP address of the Management port: <http://192.168.1.42>
If the address is unknown, perform a [manual factory reset](#).
- 3 Click either the **AIM Manager** or **System Messages** links, as appropriate.

TX Statistics

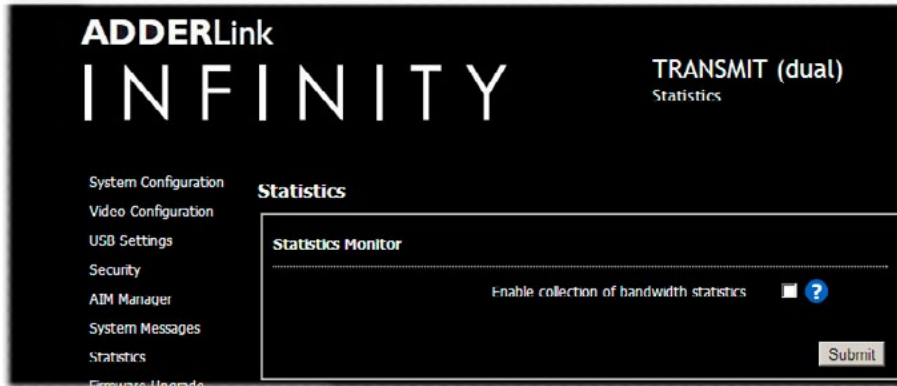

Enable collection of bandwidth statistics

The ALIF dual unit can record data transfer statistics from the System port and plot them on a graph for troubleshooting and optimization purposes. When you enable this option, you will first be presented with a pop up from which you can choose which aspects you would like to graph: Data throughput, various packet rates and/or frame rates.

Submit

Click this button after ticking the above checkbox to plot the chosen statistics on a pop up graph.

Note: Only the System port is measured. When the Teaming port is also used, the bandwidth will be shared equally so the figures shown for the System port will apply also to the Teaming port. For instance, if the graph shows 500Mbit bandwidth, then the total bandwidth will be 1 Gigabit.

TX Firmware Upgrade

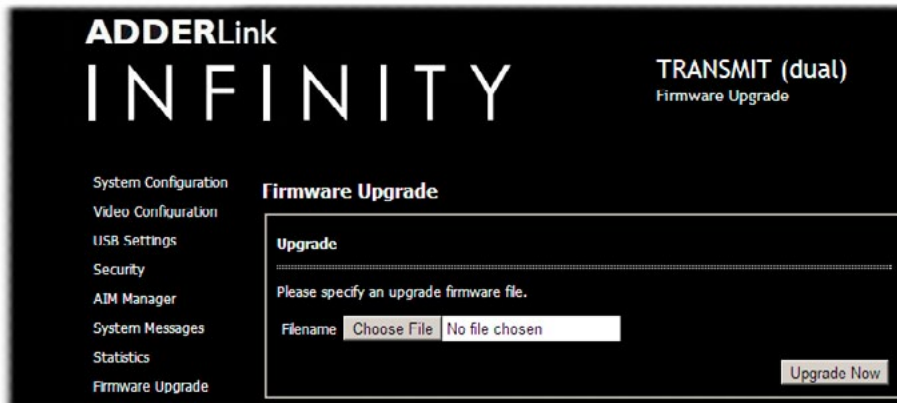

Upgrade

Use this page to upgrade the main or backup firmware image on the unit. Please see the section [Performing an upgrade](#) for details.

TX Reboot



Reboot

Use this page to perform a reboot or a factory reset. Please see the section [Manual factory reset](#) for details.

To get here

- 1 [Connect your computer to the Management port](#) on the left side of the front panel.
- 2 Run a web browser and enter the IP address of the Management port: <http://192.168.1.42>
If the address is unknown, perform a [manual factory reset](#).
- 3 Click either the **Statistics**, **Firmware Upgrade** or **Reboot** links, as appropriate.

ADDERLink

TRANSMIT (dual)

About

- System Configuration
- Video Configuration
- USB Settings
- Security
- AIM Manager
- System Messages
- Statistics
- Firmware Upgrade
- Reboot
- About

About

System Information

MAC Addresses

Unit MAC 0 address 00:0F:58:01:C2:D0

Unit MAC 1 address 00:0F:58:01:C2:D1

Unit MAC 2 address 00:0F:58:5B:C7:D1

Main System

Build number 3.0.24219

Backup System

Build number 2.9.21660

Boot System

Build number 2.9.21660

Option Switches

Option Switch 1 was up at boot time

Option Switch 2 was up at boot time

Board Revision

Board Revision is 5

System Type

System Type is TX2v

Getting Help

Contact support@adder.com or visit <http://www.adder.com> for help

About

This page displays key information about the TX unit that may be requested by Adder Technical Support.

To get here

- 1 [Connect your computer to the Management port](#) on the left side of the front panel.
- 2 Run a web browser and enter the IP address of the Management port: **http://192.168.1.42**
If the address is unknown, perform a [manual factory reset](#).
- 3 If necessary, click the **About** link.

APPENDIX B - The VNC port: Initial configuration

This section deals with the initial configuration of the VNC port of the ALIF 2112T unit. For details about the main System and Teaming ports, please [see here](#).

The default IP address of the VNC port is **192.168.1.42**; it is possible to change this either through the VNC viewer or via the [TX System Configuration](#) page.

Initial connection to the VNC port

Configuration of the VNC port section of the ALIF 2112T is carried out via a network, using a VNC Viewer program running on a computer or mobile device. VNC Viewers are available for most computers, tablets and smartphones.

- If you already have a VNC viewer, please follow the Initial configuration instructions given on the next page.
- If you do not already have a VNC viewer, there are three options:
 - You can download a Windows VNC Viewer from the ALIF 2112T itself.
 - You can download the latest VNC Viewers for most operating systems via the RealVNC website, or for tablets and smartphones from the appropriate app store.
 - Without downloading anything, you can run a Java version of the VNC Viewer inside your web browser.

To download a Windows VNC Viewer from the ALIF 2112T unit

Note: The version of VNC supplied within the ALIF 2112T supports virtual media.

- 1 Connect the ALIF 2112T to an IP network where a suitable computer is available on the same subnet (please see the Installation chapter for connection details).
- 2 On that computer, open an internet browser and enter the default local IP address used by the ALIF 2112T:

http://192.168.1.42

The ALIF 2112T welcome screen should be displayed:



- 3 Click the link 'Download the Windows VNC Viewer from unit'.
- 4 Once the file is downloaded, run it and follow the on screen instructions to open a VNC connection to the ALIF 2112T. (The VNC Viewer is a single executable file which does not require an 'installation' step. Simply put the file in a suitable place (such as the Desktop) and run it from there.)

Note on viewers

The windows VNC viewer supplied by the unit is 4.4.3se4. On the RealVNC website you will find later viewers V5. The V5 viewers support a newer 256 bit encryption technique. However, Virtual media functionality is not supported in V5 viewer.

To download a VNC Viewer

To download a (free) VNC Viewer for a desktop or notebook computer, visit the download page of the RealVNC website:

<http://www.realvnc.com/download/viewer>

To download a VNC Viewer app for a tablet or smartphone, visit the Apple or Android app store, or look at the RealVNC website (www.realvnc.com) for further information.

To use the Java VNC Viewer

- 1 Connect the ALIF 2112T to an IP network where a suitable computer is available on the same subnet (please see the Installation chapter for connection details).
- 2 On that computer, open an internet browser and enter the default IP address used by the ALIF 2112T:

http://192.168.1.42

The ALIF 2112T welcome screen should be displayed (as shown left).

- 3 Click the link Connect using built-in Java VNC Viewer. The Java viewer will load and run inside the browser. For more details see [Appendix I - Java viewer options](#).

Initial configuration

To perform the initial configuration, you need to connect the ALIF 2112T to an IP network and use a computer located on the same network to connect to it.

To perform the initial configuration

1 Connect the ALIF 2112T to an IP network (using the **VNC port**) where a suitable computer is available on the same subnet (please see the section [VNC network link](#) for connection details).

2 Use a computer connected to the same subnet of the network. On that computer, locate and select the VNC viewer icon ⇨



A connection details dialog will be displayed:

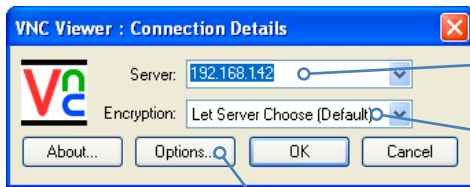

Enter the ALIF 2112T address here and click OK

If required, select the encryption mode

Options button

Provides a range of viewer and connection settings - [MORE \[+\]](#)

3 In the 'Server:' entry, type the address: **192.168.1.42**

4 Click the OK button. The viewer window may open straight away (if so continue at step 6) or the system may require user authentication in which case an authentication dialog will be displayed:

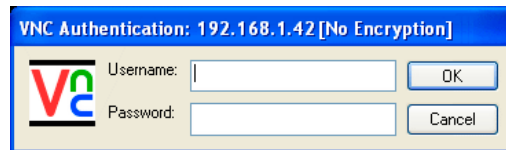

5 Enter **admin** as the Username, leave the password entry blank and click the OK button. The viewer window should now open:



Click the Configure button

6 Click the Configure button to display the Configuration menu:

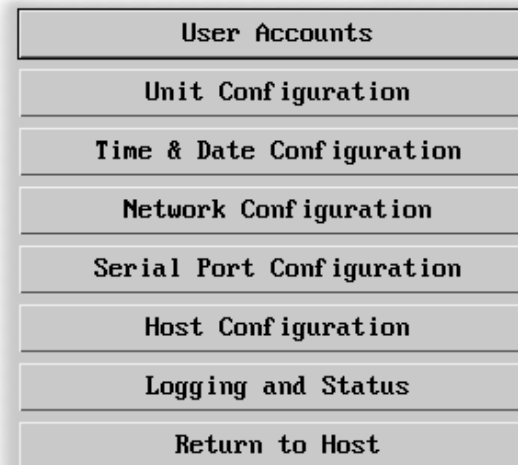

Use the various options (particularly the 'Unit Configuration' and 'Network Configuration' options) to arrange the ALIF 2112T to suit your requirements.

See [Appendix F - Configuration menus](#).

Note: To ensure that the Configuration menu is correctly displayed within the VNC viewer, the ALIF 2112T must be connected to the video output of its host computer.

Controls

When clicked, this button reveals a menu of options concerned with keyboard, video and mouse operation.

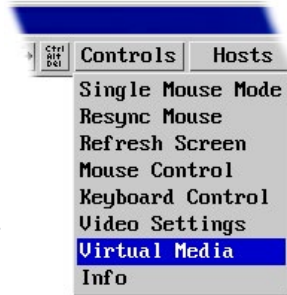

Single Mouse Mode

This mode is for fast network connections where the cursor response is sufficient to provide instant visual feedback on the remote screen. When enabled, the cursor is 'captured' within the viewer window until you use the 'escape' hot keys.

To quit from single mouse mode, press F8 and then P. Alternatively, enable and use the mouse button escape sequences - see [Advanced unit configuration](#) for details.

The single mouse mode does not require calibration.

Resync Mouse

This option has the same effect as the button on the menu bar and re-synchronizes the local and remote mouse pointers.

Refresh Screen

This option refreshes the whole screen image to remove any artefacts from moved screen items. This is useful when using very low refresh rates on slow speed communication links.

Mouse Control

This option displays a mouse control dialog and is useful when the remote cursor is failing to respond correctly to your mouse movements, even after using the Resync mouse option.

The mouse control dialog allows you to control the remote mouse cursor using a selection of buttons that you click with your local mouse.

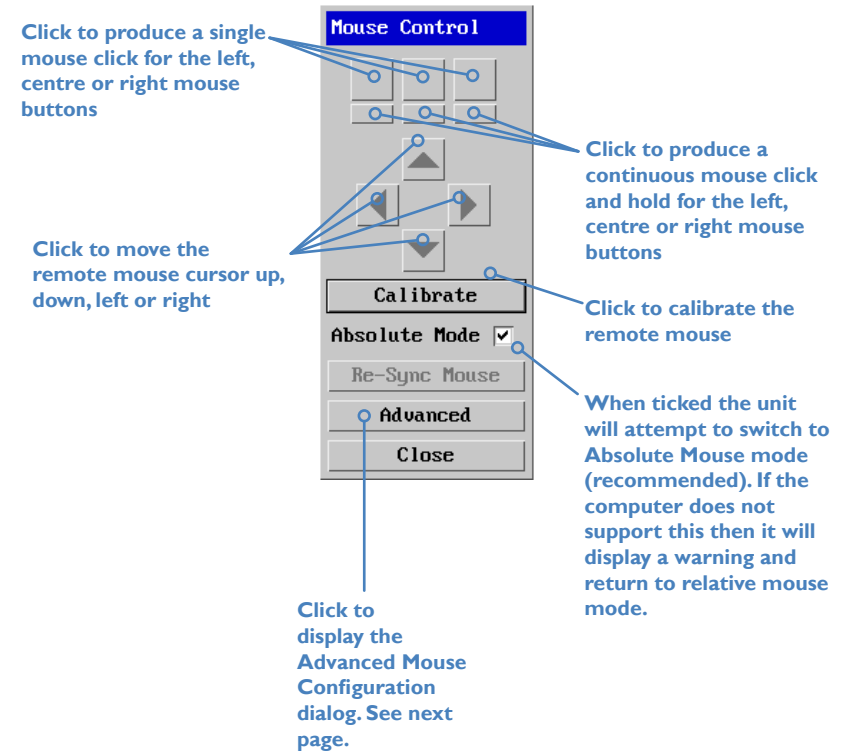

Advanced mouse configuration

This dialog allows the mouse acceleration to be configured according to the operating system in use and also permits manual fine tuning for situations where problems are encountered with the Calibrate function.

For best results, choose the appropriate *Change motion*: entry to match the host in use.

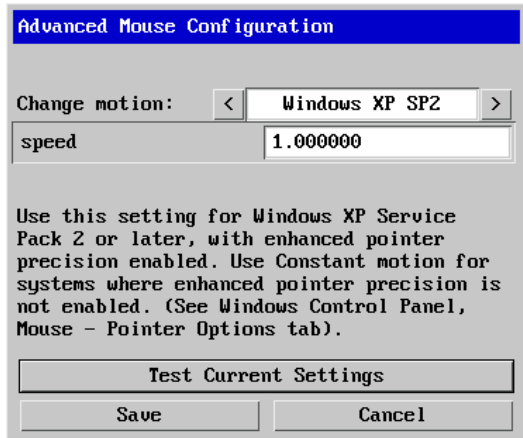

The available Change Motion schemes are: *Constant*, *XFree86*, *Windows Pre-XP*, *Windows XP*, *Windows XP SP2*, *OS/2*, *Solaris*, *Solaris 9* and *Mac OSX*. Most of these offer the Speed setting as the only option, however, the *Windows Pre-XP* and *XFree86* options contain many other parameters.

When the *Absolute Mode* option is ticked in the main [Mouse Control](#) menu, this dialog allows you to adjust the *Absolute Offset* scale:

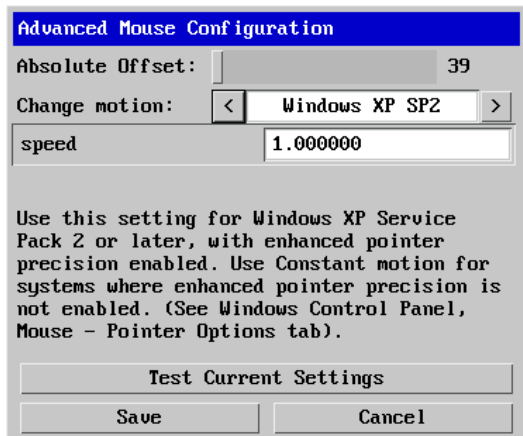

Info

When selected, this option displays an information dialog showing the current logged on users, the current host, its video mode and its mouse motion details.

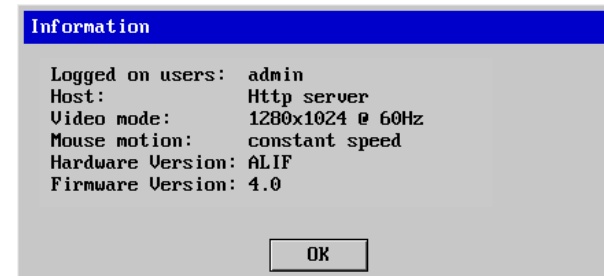

Power switching

When configured (and where you have access rights) this option allows you to control the mains power input to the currently selected host computer.

Note: This option is generally used to power cycle remote systems that have failed to respond. Before switching a system off, ensure that all attempts have first been made to power it down through normal means.

An optional power switch is required to be connected to the AUX port of the ALIF 2112T unit in order to control the mains power input into the associated computer. See also [Power switching configuration](#).

To switch a system on or off

- 1 Use the Hosts button to select the required computer.
- 2 Click the Power button and then select the Switch on or Switch off option, as appropriate.

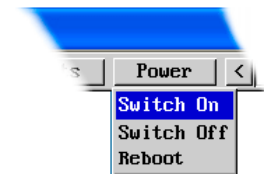

Keyboard Control

This option displays a keyboard control dialog and is useful for sending keyboard combinations (to the host) that are needed regularly or that are trapped by the ALIF 2112T.

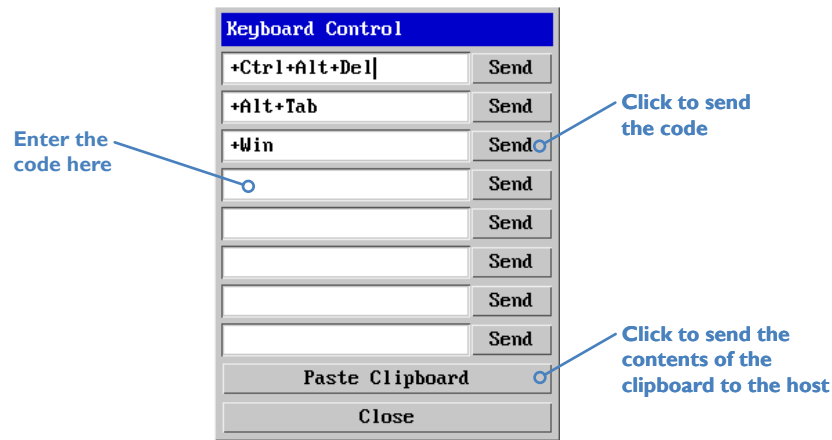

When entering codes:

- + means press down the key that follows
- means release the key that follows
- +- means press down and release the key that follows
- * means wait 250ms (note: if a number immediately follows the asterisk, then the delay will equal the number, in milliseconds)

It is automatically assumed that all keys specified will be released at the end, so there is need to specify -Ctrl or -Alt if these keys are to be released together.

Examples:

'Ctrl + Alt I2' would be expressed as: +Ctrl+ Alt+ I-I+2

+N means press the 'N' key

+Scroll means press the Scroll lock key

+Space means press the space key

Note: If using the Paste Clipboard feature, within the VNC viewer properties, ensure that in the Inputs section, the Share clipboard with server option is enabled. See [Appendix G](#) for details.

Video settings

This option provides a range of options related to the video configuration.

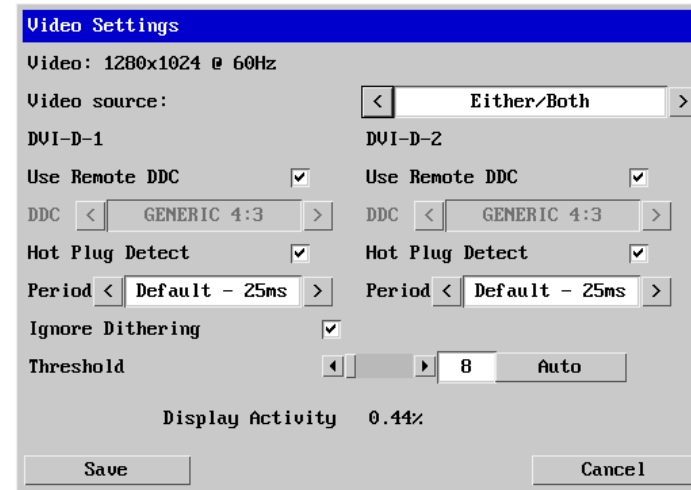

Video source

Selects which video input to use. It is possible to display both single head screens (if connected) or select one over the other. If you are viewing Dual-Link video resolutions, only one head will be available.

Use Remote DDC

Uses the DDC of the monitors connected to the ALIF Receiver. If this option is un-ticked you can select a DDC to use that is reported by the ALIF 2112T.

Hot Plug Detect

When ticked, allows you to choose one of four hot plug detect periods when, after a display is connected, the DDC information is sought.

Ignore Dithering

Dithering is a technique used by some graphics cards to improve perceived image quality by continuously slightly varying the color of each pixel. This gives the illusion of more shades of color than the display can really reproduce, and smooths the appearance of gradually shaded areas in images. Unfortunately, dithering is an issue for KVM extenders because it makes the image appear to be changing all the time even when it is static. This means that a great deal of unnecessary network data is sent to the VNC viewer, reducing the video frame rate and making mouse response appear slow.

The 'Ignore Dithering' option works by ignoring small variations in the video from frame to frame. This increases performance and reduces network traffic when the host computer is an Apple Mac or another computer that has dithered video output. It also improves performance if the video source is noisy (e.g. from a camera or a VGA-to-DVI converter). 'Ignore Dithering' is disabled by default to give full color accuracy and the best possible frame rate from non-dithered video sources.

Threshold

Adjusts the level of dithering noise that is ignored. The 'Auto' button attempts to choose a suitable value automatically, but the level can also be adjusted manually using the slider or arrow buttons. The best value is of course a compromise between capturing all the 'real' screen changes whilst ignoring the (almost invisible) dithering noise. A good way to choose the value is to watch the Display Activity indicator for a static screen. If the Threshold is too low, the Display Activity will be a high percentage while nothing is really changing. If the Threshold is too high, the Display Activity will be very low (or zero) but some real changes in the screen may be missed.

Virtual Media

The Adder Virtual Media feature allows you to remotely make files available to a host computer that is linked to the ALIF 21 I2T. Disk drives, single files or collections of files and folders up to 2GB in size can be mounted via the VNC link, and appear as a read-only disk on the host. This can prove to be an invaluable tool when upgrading host computers from remote positions.

Note: The file transfer is in one direction only, from viewer to host.

Note: Adder Virtual Media does not currently work with Apple Mac systems.

In order to use the Adder Virtual Media feature, the VM link must be made between the ALIF 21 I2T and a USB port on the host computer. See [USB link](#) for details.

There are two main ways to use Adder Virtual Media:

- Create a read-only 'virtual disk drive' on the host from one or more files chosen at the viewer end. This is useful for copying one or more files from the computer running the VNC viewer to the host computer. See below.
- Export a disk drive (e.g. CD, DVD or USB flash drive) from the viewer computer so it appears as a disk on the host attached to ALIF 21 I2T. A particular use for this is for booting or upgrading the remote host from a CD or other media that you have at the viewer end. See [next page](#).

Remotely transferring files to the host as a virtual disk drive

There are several methods of doing this. The easiest method depends on whether:

- The files are already on the clipboard of the viewer computer (following an Edit -> Copy operation). See [To remotely transfer files from the clipboard >>](#)
or
- The files still need to be selected. See [To select and remotely transfer files from the viewer computer >>](#)

Note: When using Adder Virtual Media features, within the VNC viewer properties, ensure that in the Inputs section, the Share clipboard with server and the Enable file transfer options are enabled. See [Appendix E](#) for details.

To remotely transfer files from the clipboard

- 1 On the remote system, log into the ALIF 21 I2T using the VNC viewer.
- 2 If not already done, use Windows Explorer to locate and copy the required file(s), or folder(s) to the clipboard.
- 3 Within the VNC viewer window, click the Controls button and then select the Virtual Media option. A popup similar to the following will be displayed:

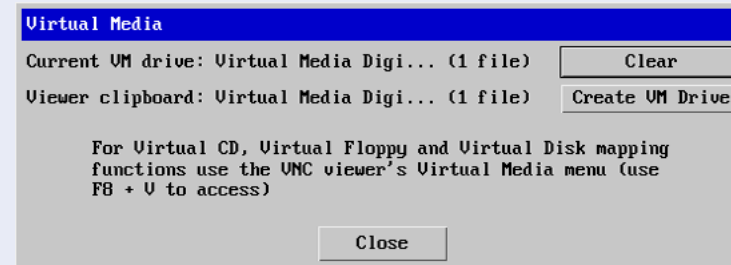

Click the Create VM Drive button to announce file availability to the host computer, whereupon a popup will confirm that the new virtual media disk is built.

Note: Remember, at this point the selected files/folders have not yet been transferred to the host system, they are just visible there.

- 4 On the host computer (via the VNC viewer) locate the new virtual drive (shown as a Removable Disk) and copy the files to the required location on the host computer.

To select and remotely transfer files from the viewer computer

- 1 On the remote system, log into the ALIF 21 I2T using the VNC viewer.
- 2 Invoke the "Send Files" feature of the VNC viewer (called "File Transfer" in later versions), either by clicking the icon on the viewer's toolbar or selecting from the F8 menu.
- 3 The viewer will display a window allowing you to select files or a whole folder. Highlight the required files or folders (up to a maximum of 2GB) that you wish to transfer to the host computer and click the Open button. The new disk drive should appear on the host a few seconds later.

Note: The Use Entire Folder button provides a quick way to select a whole folder while you are viewing its contents.

Note: Remember, at this point the selected files/folders have not yet been transferred to the host system, they are just visible there.

- 4 On the host computer (via the VNC viewer) locate the new virtual drive (shown as a Removable Disk) and copy the files to the required location on the host computer.

Remotely exporting a disk drive to the host

- 1 On the remote system, log into the ALIF 21 I2T using the VNC viewer.
- 2 Press **F8** and then **V** to display a Virtual Media dialog box:

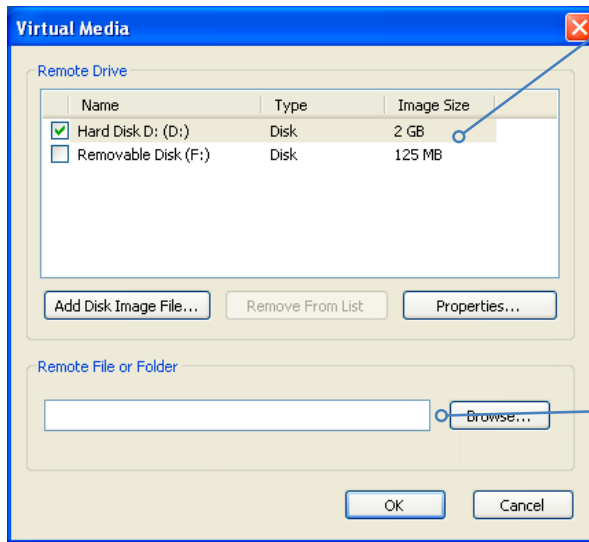

Remote Drive(s)

This section lists any located storage devices on the remote system that are 2GB or less, and which could be copied en masse to the host computer, if desired.

When the Create ISO Image option is ticked this creates a bootable disk so that it's possible to boot the host computer from the virtual media drive.

Remote Files or Folders

Click Browse to search for and select single or multiple files/folders to be copied to the host computer.

- 3 You can select an entire drive or a disk image (e.g. .iso) file:
 - Select a disk drive: Click the checkbox adjacent to the listed disk drive that you wish to make available to the host computer,
 or
 - Add a Disk Image File: Select the disk image file and click Open.
- 4 In the Virtual Media dialog box, click the OK button to announce the availability of the drive to the host computer. On the host computer, the new drive will appear in the same way as any removable drive would on your computer.

Note: Remember, at this point the selected drive has not yet been transferred to the host system, it is just visible there.
- 5 On the host computer (either directly or via the VNC viewer) locate the new virtual drive (shown as a Removable Disk) and copy the files to the required location on the host computer.

Note: The Remote File or Folder section of this Virtual Media dialog box provides yet another method of creating a virtual drive from some files or folders, as described above.

Editing the viewer window menu bar

If required, you can customize the menu bar of the viewer window to ensure that it contains only the necessary options.

The menu bar can be edited locally by each user or edited singly by the admin or alternatively, the admin can globally alter the menu bar for all users.

To edit the menu bar locally

- 1 Login remotely via VNC viewer and display the viewer window.
- 2 Place the mouse pointer on the menu bar and click the right mouse button. A popup will be displayed:



- 3 Click on any option within the popup to add it to or remove it from the menu bar.
- 4 When all changes have been made, click anywhere else within the viewer window. Changes made in this way will affect the individual user only.

Note: The local menu bar edit popup shown above will only appear if the *Enable direct right click Menu editing* option is ticked within the Gui Edit Configuration screen (for that user) as shown right.

To edit the menu bar via admin

- 1 Login remotely via VNC viewer as admin user and display the viewer window.
- 2 Click the Configure button in the top right corner of the viewer window.
- 3 Click the User Accounts button.
- 4 Against the entry for the required user, click the Menu Bar Edit button. The following dialog will be displayed:



- 5 Select/deselect the items that you wish to appear on the menu bar. As you do so, the Menu bar appearance image will show how the bar will look using your edited settings.
- 6 Optional: To globally apply your changes, tick the Apply to all users on Save option.
- 7 Click the Save button.

APPENDIX C - Tips for success when networking ALIF units

ALIF units use multiple strategies to minimize the amount of data that they send across networks. However, data overheads can be quite high, particularly when very high resolution video is being transferred, so it is important to take steps to maximize network efficiency and help minimize data output. The tips given in this section have been proven to produce very beneficial results.

Summary of steps

- Choose the right kind of switch.
- Create an efficient network layout.
- Configure the switches and devices correctly.

Choosing the right switch

Layer 2 switches are what bind all of the hosts together in the subnet. However, they are all not created equally, so choose carefully. In particular look for the following:

- Gigabit (1000Mbps) or faster Ethernet ports,
- Support for [IGMP v2](#) (or v3) snooping,
- Support for [Jumbo frames](#) up to 9216-byte size,
- High bandwidth connections between switches, preferably Fiber Channel.
- Look for switches that perform their most onerous tasks (e.g. [IGMP snooping](#)) using multiple dedicated processors (ASICs).
- Ensure the maximum number of concurrent ‘snoopable groups’ the switch can handle meets or exceeds the number of ALIF transmitters that will be used to create multicast groups.
- Check the throughput of the switch: Full duplex, 1Gbps up- and down- stream speeds per port.
- Use the same switch make and model throughout a single subnet.
- You also need a **Layer 3** switch. Ensure that it can operate efficiently as an [IGMP Querier](#).

Layer 2 (and Layer 3) switches known to work

- | | | |
|--------------|-------------------------|--------------------------------------|
| • Cisco 2960 | • Extreme Networks X480 | • H3C 5120 |
| • Cisco 3750 | • HP Procurve 2810 | • HuaWei Quidway s5328c-E1 (Layer 3) |
| • Cisco 4500 | • HP Procurve 2910 | |
| • Cisco 6500 | | |

For the latest list of switches known to work with ALIF and setup instructions for them, please go to www.adder.com

Creating an efficient network layout

Network layout is vital. The use of [IGMP snooping](#) also introduces certain constraints, so take heed:

- Keep it flat. Use a basic line-cascade structure rather than a pyramid or tree arrangement.
- Keep the distances between the switches as short as possible.
- Ensure sufficient bandwidth between switches to eliminate bottlenecks.
- Where the A.I.M. server is used to administer multiple ALIF transceivers, ensure the A.I.M. server and all ALIF units reside in the same subnet.
- Do not use VGA to DVI converters, instead replace VGA video cards in older systems with suitable DVI replacements. Converters cause ALIF TX units to massively increase data output.
- Wherever possible, create a private network.

The recommended layout

The layout shown below has been found to provide the most efficient network layout for rapid throughput when using IGMP snooping:

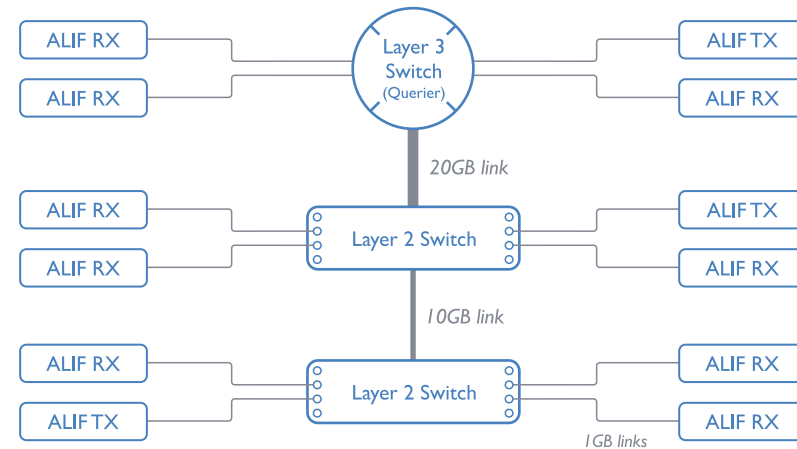

- Use no more than two cascade levels.
- Ensure high bandwidth between the two L2 switches and very high bandwidth between the top L2 and the L3. Typically 10GB and 20GB, respectively for 48 port L2 switches.

continued

Configuring the switches and devices

The layout is vital but so too is the configuration:

- Enable [IGMP Snooping](#) on all L2 switches.
- Ensure that [IGMP Fast-Leave](#) is enabled on all switches with ALIF units connected directly to them.
- Enable the L3 switch as an [IGMP Querier](#).
- Enable [Spanning Tree Protocol \(STP\)](#) on all switches and importantly also enable portfast (only) on all switch ports that have ALIF units connected.
- If any hosts will use any video resolutions using 2048 horizontal pixels (e.g. 2048 x 1152), ensure that [Jumbo Frames](#) are enabled on all switches.
- Choose an appropriate forwarding mode on all switches. Use [Cut-through](#) if available, otherwise [Store and forward](#).
- Color the settings on the ALIF transmitters:
 - If color quality is important, then leave Colour Depth at 24 bits and adjust other controls,
 - If moving video images are being shown frequently, then leave Frame Skipping at a low percentage and instead reduce the Peak bandwidth limiter and Colour Depth.
 - Where screens are quite static, try increasing the Background Refresh interval and/or increasing the Frame skipping percentage setting.

Make changes to the ALIF transmitters one at a time, in small steps, and view typical video images so that you can attribute positive or negative results to the appropriate control.

- Ensure that all ALIF units are fully updated to the latest firmware version (at least v2.1).

APPENDIX D - Troubleshooting

Problem: The video image of the ALIF receiver shows horizontal lines across the screen.

This issue is known as *Blinding* because the resulting video image looks as though you're viewing it through a venetian blind.

When video is transmitted by ALIF units, the various lines of each screen are divided up and transmitted as separate data packets. If the reception of those packets is disturbed, then blinding is caused. The lines are displayed in place of the missing video data packets.

There are several possible causes for the loss of data packets:

- Incorrect switch configuration. The problem could be caused by multicast flooding, which causes unnecessary network traffic. This is what IGMP snooping is designed to combat, however, there can be numerous causes of the flooding.
- Speed/memory bandwidth issues within one or more switches. The speed and capabilities of different switch models varies greatly. If a switch cannot maintain pace with the quantity of data being sent through it, then it will inevitably start dropping packets.
- One or more ALIF units may be outputting Jumbo frames due to the video resolution (2048 horizontal pixels) being used. If jumbo frames are output by an ALIF unit, but the network switches have not been configured to use jumbo frames, the switches will attempt to break the large packets down into standard packets. This process introduces a certain latency and could be a cause for dropped packets.
- One or more ALIF units may be using an old firmware version. Firmware versions prior to v2.1 exhibited an issue with the timing of IGMP join and leave commands that caused multicast flooding in certain configurations.

Remedies:

- Ensure that [IGMP snooping](#) is enabled on all switches within the subnet.
- Where each ALIF unit is connected as the sole device on a port connection to a switch, enable [IGMP Fast-Leave \(aka Immediate Leave\)](#) to reduce unnecessary processing on each switch.
- Check the video resolution(s) being fed into the ALIF transmitters. If resolutions using 2048 horizontal pixels are unavoidable then ensure that [Jumbo frames](#) are enabled on all switches.
- Check the [forwarding mode](#) on the switches. If *Store and forward* is being used, try selecting *Cut-through* as this mode causes reduced latency on lesser switch designs.
- Ensure that one device within the subnet is correctly configured as an [IGMP Querier](#), usually a layer 3 switch or multicast router.
- Ensure that the firmware in every ALIF unit is version 2.1 or greater.
- Try adjusting the transmitter settings on each ALIF to make the output data stream as efficient as possible. See [ALIF transmitter video settings](#) for details.

continued

Problem:The mouse pointer of the ALIF receiver is slow or sluggish when moved across the screen.

This issue is often related to either using dithering on the video output of one or more transmitting computers or using VGA-to-DVI video converters.

Dithering is used to improve the perceived quality and color depth of images by diffusing or altering the color of pixels between video frames. This practice is commonly used on Apple Mac computers using ATI or Nvidia graphics cards. VGAto-DVI converters unwittingly produce a similar issue by creating high levels of pixel background noise.

ALIF units attempt to considerably reduce network traffic by transmitting only the pixels that change between successive video frames. When dithering is enabled and/or VGA-to-DVI converters are used, this can have the effect of changing almost every pixel between each frame, thus forcing the ALIF transmitter to send the whole of every frame: resulting in greatly increased network traffic and what's perceived as sluggish performance.

Remedies:

- Linux PCs
Check the video settings on the PC. If the Dither video box option is enabled, disable it.
- Apple Mac with Nvidia graphics
Use the Adder utility for Mac's – Contact technical support.
- Apple Mac with ATI graphics
[Enable the Magic Eye dither removal feature.](#)
- Windows PCs
If you suspect these issues with PC's, contact technical support for assistance.
- Replace old VGA adapters on host computers with DVI video cards.

Problem:The audio output of the ALIF receiver sounds like a scratched record.

This issue is called Audio crackle and is a symptom of the same problem that produces blinding (see previous page). The issue is related to missing data packets.

Remedies:

As per blinding discussed previously.

Problem:A.I.M. cannot locate working ALIF units.

There are a few possible causes:

- The ALIF units must be reset back to their zero config IP addresses for A.I.M. discovery. If you have a working network of ALIF's without A.I.M. and then add A.I.M. to the network A.I.M. will not discover the ALIFs until they are reset to the zero config IP addresses.
- This could be caused by Layer 2 Cisco switches that have [Spanning Tree Protocol \(STP\)](#) enabled but do not also have *portfast* enabled on the ports to which ALIF units are connected. Without portfast enabled, ALIF units will all be assigned the same zero config IP address at reboot and A.I.M. will only acquire them one at a time on a random basis.

You can easily tell whether portfast is enabled on a switch that is running STP: When you plug the link cable from a working ALIF unit into the switch port, check how long it takes for the port indicator to change from orange to green. If it takes roughly one second, portfast is on; if it takes roughly thirty seconds then portfast is disabled.

Remedies:

- Ensure that the ALIF units and the A.I.M. server are located within the same subnet because A.I.M. cannot cross subnet boundaries.
- [Manually reset](#) the ALIF units to their zero config IP addresses.
- Enable portfast on all switch ports that have ALIF units attached to them or try temporarily disabling STP on the switches while A.I.M. is attempting to locate ALIF units.

APPENDIX E - Glossary

Internet Group Management Protocol

Where an ALIF transmitter is required to stream video to two or more receivers, multicasting is the method used.

Multicasting involves the delivery of identical data to multiple receivers simultaneously without the need to maintain individual links. When multicast data packets enter a subnet, the natural reaction of the switches that bind all the hosts together within the subnet, is to spread the multicast data to all of their ports. This is referred to as Multicast flooding and means that the hosts (or at least their network interfaces) are required to process plenty of data that they didn't request. IGMP offers a partial solution.

The Internet Group Management Protocol (IGMP) is designed to prevent multicast flooding by allowing [Layer 3](#) switches to check whether host computers within their care are interested in receiving particular multicast transmissions. They can then direct multicast data only to those points that require it and can shut off a multicast stream if the subnet has no recipients.

There are currently three IGMP versions: 1, 2 and 3, with each version building upon the capabilities of the previous one:

- IGMPv1 allows host computers to opt into a multicast transmission using a Join Group message, it is then incumbent on the router to discover when they no longer wish to receive; this is achieved by polling them (see IGMP Querier below) until they no longer respond.
- IGMPv2 includes the means for hosts to opt out as well as in, using a Leave Group message.
- IGMPv3 encompasses the abilities of versions 1 and 2 but also adds the ability for hosts to specify particular sources of multicast data.

AdderLink Infinity units make use of IGMPv2 when performing multicasts to ensure that no unnecessary congestion is caused.

IGMP Snooping

The IGMP messages are effective but only operate at [layer 2](#) - intended for routers to determine whether multicast data should enter a subnet. A relatively recent development has taken place within the switches that glue together all of the hosts within each subnet: IGMP Snooping. IGMP snooping means these layer 2 devices now have the ability to take a peek at the IGMP messages. As a result, the switches can then determine exactly which of their own hosts have requested to receive a multicast – and only pass on multicast data to those hosts.

IGMP Querier

When IGMP is used, each subnet requires one [Layer 3](#) switch to act as a Querier. In this lead role, the switch periodically sends out IGMP Query messages and in response all hosts report which multicast streams they wish to receive. The Querier device and all snooping Layer 2 switches, then update their lists accordingly (the lists are also updated when Join Group and Leave Group (IGMPv2) messages are received).

IGMP Fast-Leave (aka Immediate Leave)

When a device/host no longer wishes to receive a multicast transmission, it can issue an IGMP Leave Group message as mentioned above. This causes the switch to issue an IGMP Group-Specific Query message on the port (that the Leave Group was received on) to check no other receivers exist on that connection that wish to remain a part of the multicast. This process has a cost in terms of switch processor activity and time.

Where ALIF units are connected directly to the switch (with no other devices on the same port) then enabling IGMP Fast-Leave mode means that switches can immediately remove receivers without going through a full checking procedure. Where multiple units are regularly joining and leaving multicasts, this can speed up performance considerably.

Jumbo frames (Jumbo packets)

Since its commercial introduction in 1980, the Ethernet standard has been successfully extended and adapted to keep pace with the ever improving capabilities of computer systems. The achievable data rates, for instance, have risen in ten-fold leaps from the original 10Mbit/s to a current maximum of 100Gbit/s.

While data speeds have increased massively, the standard defining the number of bytes (known as the Payload) placed into each data packet has remained resolutely stuck at its original level of 1500 bytes. This standard was set during the original speed era (10Mbits/s) and offered the best compromise at that speed between the time taken to process each packet and the time required to resend faulty packets due to transmission errors.

But now networks are much faster and files/data streams are much larger; so time for a change? Unfortunately, a wholesale change to the packet size is not straightforward as it is a fundamental standard and changing it would mean a loss of backward compatibility with older systems.

Larger payload options have been around for a while, however, they have often been vendor specific and at present they remain outside the official standard. There is, however, increased consensus on an optional 'Jumbo' payload size of 9000 bytes and this is fully supported by the AdderLink Infinity (ALIF) units.

Jumbo frames (or Jumbo packets) offer advantages for ALIF units when transmitting certain high resolution video signals across a network. This is because the increased data in each packet reduces the number of packets that need to be transferred and dealt with - thus reducing latency times.

The main problem is that for jumbo frames to be possible on a network, all of the devices on the network must support them.

Spanning Tree Protocol (STP)

In order to build a robust network, it is necessary to include certain levels of redundancy within the interconnections between switches. This will help to ensure that a failure of one link does not lead to a complete failure of the whole network.

The danger of multiple links is that data packets, especially multicast packets, become involved in continual loops as neighbouring switches use the duplicated links to send and resend them to each other.

To prevent such bridging loops from occurring, the Spanning Tree Protocol (STP), operating at [layer 2](#), is used within each switch. STP encourages all switches to communicate and learn about each other. It prevents bridging loops by blocking newly discovered links until it can discover the nature of the link: is it a new host or a new switch?

The problem with this is that the discovery process can take up to 50 seconds before the block is lifted, causing problematic timeouts.

The answer to this issue is to enable the portfast variable for all host links on a switch. This will cause any new connection to go immediately into forwarding mode. However, take particular care not to enable portfast on any switch to switch connections as this will result in bridging loops.

ALIF transmitter video settings

Each ALIF transmitter includes controls to help you customize how video data is transmitted. When configured correctly for the application, these can help to increase data efficiency.

Background Refresh

The transmitter sends portions of the video image only when they change. In order to give the best user experience, the transmitter also sends the whole video image, at a lower frame rate, in the background. The Background Refresh parameter controls the rate at which this background image is sent. The default value is 'every 32 frames', meaning that a full frame is sent in the background every 32 frames. Reducing this to 'every 64 frames' or more will reduce the amount of bandwidth that the transmitter consumes. On a high-traffic network this parameter should be reduced in this way to improve overall system performance.

Colour Depth

This parameter determines the number of bits required to define the color of every pixel. The maximum (and default) value is '24 bit'. By reducing the value you can significantly reduce bandwidth consumption, at the cost of video color reproduction.

Peak Bandwidth Limiter

The transmitter will employ a 'best effort' strategy in sending video and other data over the IP network. This means it will use as much of the available network bandwidth as necessary to achieve optimal data quality, although typically the transmitter will use considerably less than the maximum available.

In order to prevent the transmitter from 'hogging' too much of the network capacity, you can reduce this setting to place a tighter limit on the maximum bandwidth permissible to the transmitter.

Frame Skipping

Frame Skipping involves 'missing out' video frames between those captured by the transmitter. For video sources that update only infrequently or for those that update very frequently but where high fidelity is not required, frame skipping is a good strategy for reducing the overall bandwidth consumed by the system.

Forwarding modes

In essence, the job of a layer 2 switch is to transfer as fast as possible, data packets arriving at one port out to another port as determined by the destination address. This is known as data forwarding and most switches offer a choice of methods to achieve this. Choosing the most appropriate forwarding method can often have a sizeable impact on the overall speed of switching:

- **Store and forward** is the original method and requires the switch to save each entire data packet to buffer memory, run an error check and then forward if no error is found (or otherwise discard it).
- **Cut-through** was developed to address the latency issues suffered by some store and forward switches. The switch begins interpreting each data packet as it arrives. Once the initial addressing information has been read, the switch immediately begins forwarding the data packet while the remainder is still arriving. Once all of the packet has been received, an error check is performed and, if necessary, the packet is tagged as being in error. This checking ‘on-the-fly’ means that cut-through switches cannot discard faulty packets themselves. However, on receipt of the marked packet, a host will carry out the discard process.
- **Fragment-free** is a hybrid of the above two methods. It waits until the first 64 bits have been received before beginning to forward each data packet. This way the switch is more likely to locate and discard faulty packets that are fragmented due to collisions with other data packets.
- **Adaptive** switches automatically choose between the above methods. Usually they start out as a cut-through switches and change to store and forward or fragment-free methods if large number of errors or collisions are detected.

So which one to choose? The *Cut-through* method has the least latency so is usually the best to use with AdderLink Infinity units. However, if the network components and/or cabling generate a lot of errors, the *Store and forward* method should probably be used. On higher end store and forward switches, latency is rarely an issue.

Layer 2 and Layer 3: The OSI model

When discussing network switches, the terms Layer 2 and Layer 3 are very often used. These refer to parts of the Open System Interconnection (OSI) model, a standardized way to categorize the necessary functions of any standard network.

There are seven layers in the OSI model and these define the steps needed to get the data created by you (imagine that you are Layer 8) reliably down onto the transmission medium (the cable, optical fiber, radio wave, etc.) that

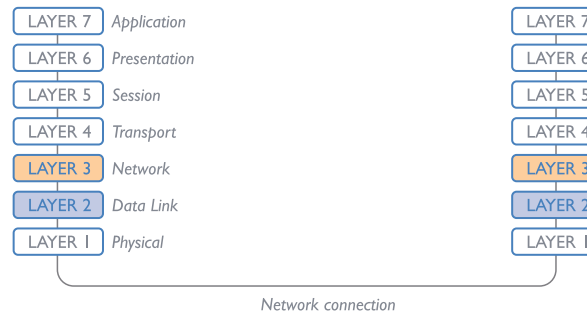

carries the data to another user; to complete the picture, consider the transmission medium is Layer 0. In general, think of the functions carried out by the layers at the top as being complex, becoming less complex as you go lower down.

As your data travel down from you towards the transmission medium (the cable), they are successively encapsulated at each layer within a new wrapper (along with a few instructions), ready for transport. Once transmission has been made to the intended destination, the reverse occurs: Each wrapper is stripped away and the instructions examined until finally only the original data are left.

So why are Layer 2 and Layer 3 of particular importance when discussing AdderLink Infinity? Because the successful transmission of data relies upon fast and reliable passage through network switches – and most of these operate at either Layer 2 or Layer 3.

The job of any network switch is to receive each incoming network packet, strip away only the first few wrappers to discover the intended destination then rewrap the packet and send it in the correct direction.

In simplified terms, the wrapper that is added at Layer 2 (by the sending system) includes the physical address of the intended recipient system, i.e. the unique MAC address (for example, 09:f8:33:d7:66:12) that is assigned to every networking device at manufacture. Deciphering recipients at this level is more straightforward than at Layer 3, where the address of the recipient is represented by a logical IP address (e.g. 192.168.0.10) and requires greater knowledge of the surrounding network structure. Due to their more complex circuitry, Layer 3 switches are more expensive than Layer 2 switches of a similar build quality and are used more sparingly within installations.

APPENDIX F - Configuration menus (via VNC)

When viewing remotely via VNC, the unit has a main configuration menu through which you can access various sub menus to configure particular items.

To view the main configuration menu

- 1 Using VNC viewer or a browser; log on as the 'admin' user.
- 2 Click the 'Configure' button in the top right corner. The main configuration menu will be displayed:

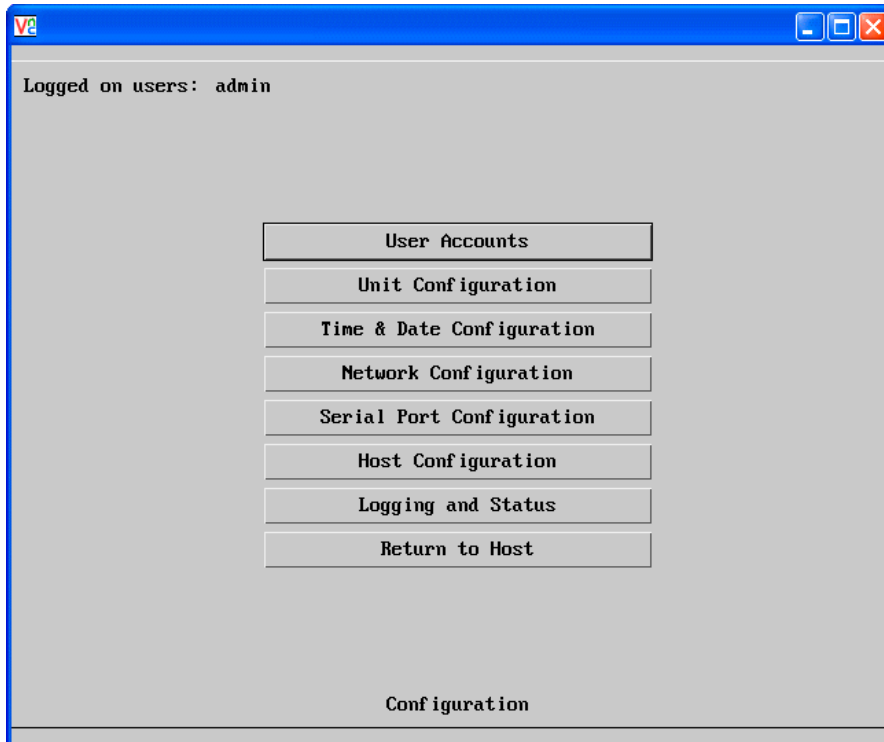

The various configuration pages are covered within this appendix:

- [User accounts](#)
 - [Gui edit configuration](#)
- [Unit configuration](#)
 - [Advanced unit configuration](#)
- [Time & date configuration](#)
- [Network configuration](#)
- [Serial port configuration](#)
- [Host configuration](#)
 - [Power switching configuration](#)
- [Logging and status](#)

User accounts

Up to 16 users can be created by the admin user, each with their password. One of the 16 users can be the admin user. This user has access to the units configuration menu. Ticking the 'IsAdmin' box creates the Admin user. The admin user can also determine whether the users are allowed access to the power control menu in order to turn servers on and off.

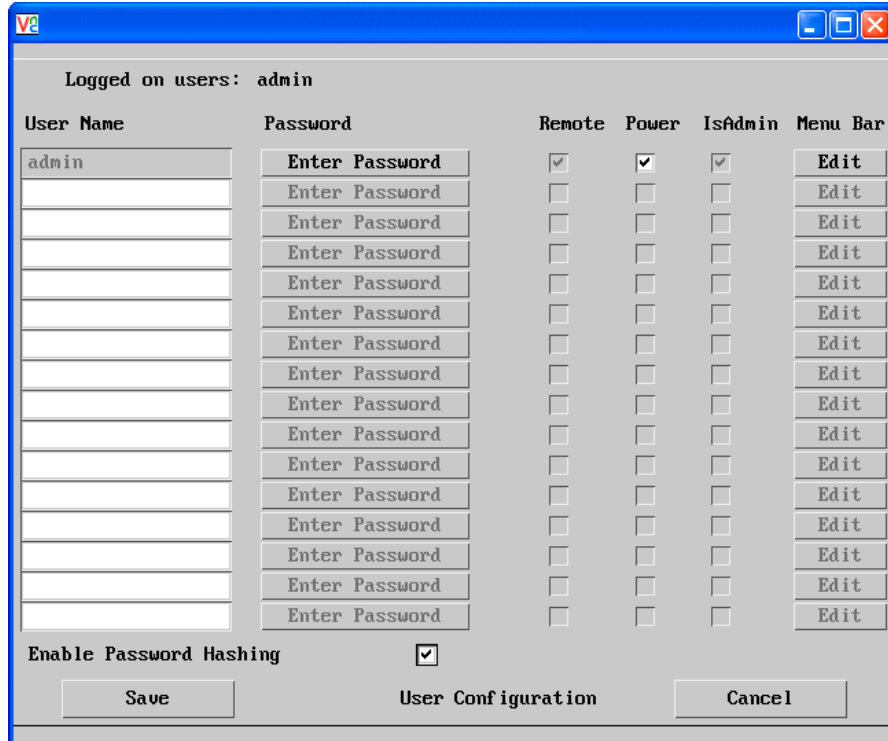

User Name	Password	Remote	Power	IsAdmin	Menu Bar
admin	Enter Password	<input checked="" type="checkbox"/>	<input checked="" type="checkbox"/>	<input checked="" type="checkbox"/>	Edit
	Enter Password	<input type="checkbox"/>	<input type="checkbox"/>	<input type="checkbox"/>	Edit
	Enter Password	<input type="checkbox"/>	<input type="checkbox"/>	<input type="checkbox"/>	Edit
	Enter Password	<input type="checkbox"/>	<input type="checkbox"/>	<input type="checkbox"/>	Edit
	Enter Password	<input type="checkbox"/>	<input type="checkbox"/>	<input type="checkbox"/>	Edit
	Enter Password	<input type="checkbox"/>	<input type="checkbox"/>	<input type="checkbox"/>	Edit
	Enter Password	<input type="checkbox"/>	<input type="checkbox"/>	<input type="checkbox"/>	Edit
	Enter Password	<input type="checkbox"/>	<input type="checkbox"/>	<input type="checkbox"/>	Edit
	Enter Password	<input type="checkbox"/>	<input type="checkbox"/>	<input type="checkbox"/>	Edit
	Enter Password	<input type="checkbox"/>	<input type="checkbox"/>	<input type="checkbox"/>	Edit
	Enter Password	<input type="checkbox"/>	<input type="checkbox"/>	<input type="checkbox"/>	Edit
	Enter Password	<input type="checkbox"/>	<input type="checkbox"/>	<input type="checkbox"/>	Edit
	Enter Password	<input type="checkbox"/>	<input type="checkbox"/>	<input type="checkbox"/>	Edit
	Enter Password	<input type="checkbox"/>	<input type="checkbox"/>	<input type="checkbox"/>	Edit
	Enter Password	<input type="checkbox"/>	<input type="checkbox"/>	<input type="checkbox"/>	Edit
	Enter Password	<input type="checkbox"/>	<input type="checkbox"/>	<input type="checkbox"/>	Edit

Enable Password Hashing

Save User Configuration Cancel

To get here

- 1 Using VNC viewer or a browser, log on as the 'admin' user.
- 2 Click the 'Configure' button in the top right corner.
- 3 Click the 'User Accounts' option.

User Name

All user names must consist of lower case characters or numbers only. No symbols or upper case characters are permissible. The user name can be between 1 and 32 characters in length but cannot contain foreign characters.

Password

Each password can be between 1 and 16 characters in length. A suitable password is best constructed using a mixture of more than 6 letters, numbers and punctuation characters.

Local

This column is greyed out as this feature is not available on ALIF 2112T.

Remote

When ticked, the selected user can gain access via an IP network link (such as a local intranet or the wider Internet, depending on how the ALIF 2112T is connected) and/or Console Server access.

Power

When ticked, the selected user will be permitted to control the power input to host systems (requires optional power control switch unit(s) to be fitted).

Menu Bar

Optionally click to customize the menu bar for each user. See next page.

Enable Password Hashing

This enables the storing of passwords in an encrypted format, which provides added security.

Gui edit configuration

If required, you can customize the menu bar of the viewer window to ensure that it contains only the necessary options.

The menu bar can be edited locally by each user or edited singly by the admin or alternatively, the admin can globally alter the menu bar for all users.

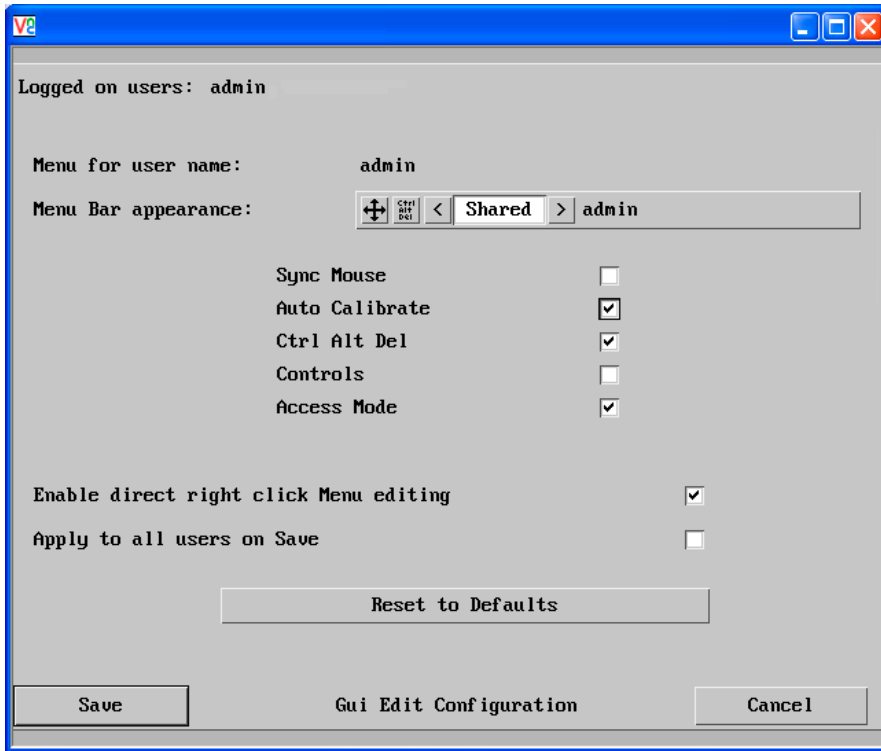

To globally edit the menu bar via admin

- 1 Using VNC viewer or a browser, log on as the 'admin' user.
- 2 Click the 'Configure' button in the top right corner.
- 3 Click on User Configuration
- 4 Click on the relevant Edit button.

To edit the menu bar locally

- 1 Login remotely via VNC viewer and display the viewer window.
- 2 Place the mouse pointer on the menu bar and click the right mouse button. A popup will be displayed:



- 3 Click on any option within the popup to add it to or remove it from the menu bar.
- 4 When all changes have been made, click anywhere else within the viewer window. Changes made in this way will affect the individual user only.

Unit configuration

This page provides access to a selection of both basic and advanced settings for the ALIF 2112T. Many of the settings displayed here are also accessible through the on-screen menu.

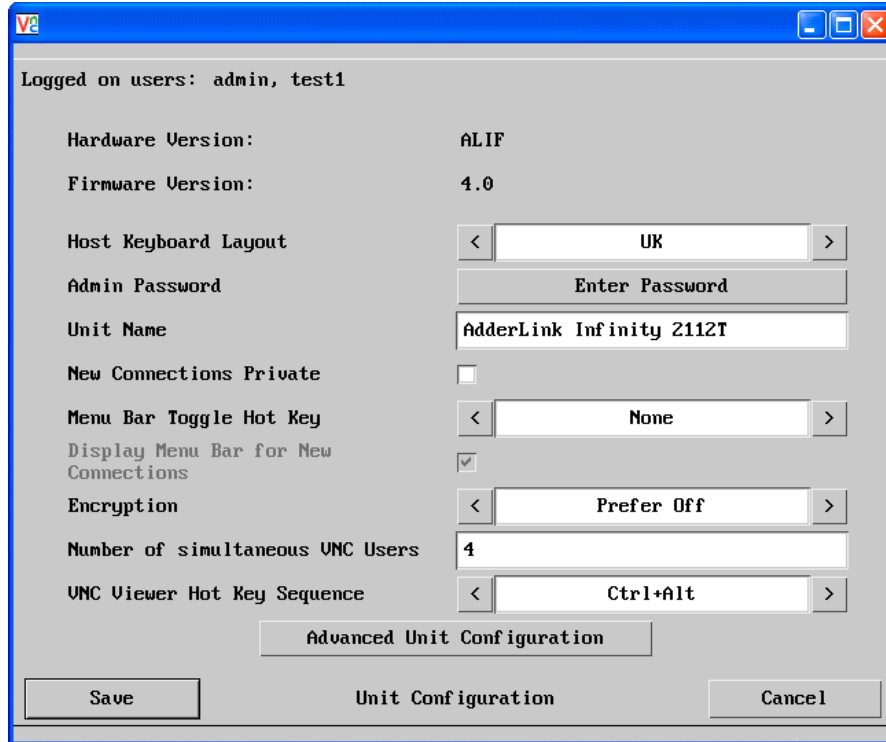

Logged on users: admin, test1

Hardware Version: ALIF

Firmware Version: 4.0

Host Keyboard Layout: < UK >

Admin Password: Enter Password

Unit Name: AdderLink Infinity 2112T

New Connections Private:

Menu Bar Toggle Hot Key: < None >

Display Menu Bar for New Connections:

Encryption: < Prefer Off >

Number of simultaneous VNC Users: 4

VNC Viewer Hot Key Sequence: < Ctrl+Alt >

Advanced Unit Configuration

Save Unit Configuration Cancel

Hardware Version

Indicates the version of the electronic circuitry within the ALIF 2112T unit.

Firmware Version

Indicates the version of the internal software within the ALIF 2112T flash memory. This may be updated using the [flash upgrade procedure](#).

Host Keyboard Layout

Use the arrow buttons to match the keyboard layout expected by the host system.

Admin (Change) Password

Click this button to enter/edit the password that will be used to gain administrator access to the ALIF 2112T.

To get here

- 1 Using VNC viewer or a browser, log on as the 'admin' user.
- 2 Click the 'Configure' button in the top right corner.
- 3 Click the 'Unit Configuration' option.

Unit Name

The name entered here will be displayed on the local menus and the remote VNC viewer/browser windows.

New Connections Private

Allows you to determine whether new local or VNC connections should be set up as private (when ticked) or as shared (when unticked).

Menu Bar Toggle Hot Key

Determines the function key that can be used to display/hide the menu bar within the VNC screen.

Encryption

Four options are available: Always On, Prefer Off, Prefer On, or Maximum. The one to choose depends on the specific details of your installation. The use of encryption imposes a slight performance overhead of roughly 10% but is highly secure against third party intrusion. Maximum selects 256 bit encryption.

Number of simultaneous VNC Users

Allows you to restrict the number of concurrent VNC sessions. The maximum number is 16 and the default is 4.

VNC Viewer Hot Key Sequence

When using the VNC Viewer, you can use key press combinations to select host computers and also to display the host selection menu. This option allows you to choose which keys should be used to form the hotkeys that will precede a switching command. The default setting is CTRL + ALT, so as an example when you press the CTRL ALT and 2 keys, the viewer will change to the host with "Hotkey Host Number" 2 - see [Host configuration](#).

[Advanced Unit Configuration](#)

Advanced unit configuration

Click this button to display advanced options that do not normally require alteration.

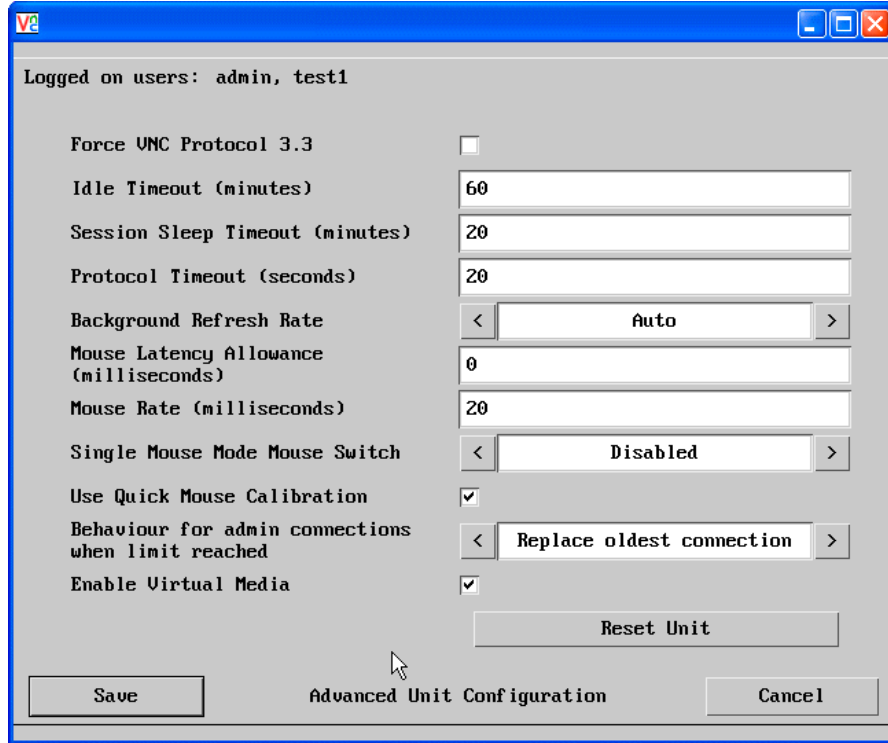

Logged on users: admin, test1

Force UNC Protocol 3.3

Idle Timeout (minutes)

Session Sleep Timeout (minutes)

Protocol Timeout (seconds)

Background Refresh Rate

Mouse Latency Allowance (milliseconds)

Mouse Rate (milliseconds)

Single Mouse Mode Mouse Switch

Use Quick Mouse Calibration

Behaviour for admin connections when limit reached

Enable Virtual Media

Force VNC Protocol 3.3

IMPORTANT: Protocol 3.3 is a legacy version that does not offer any encryption. Hashed passwords are not supported with 3.3

Idle Timeout

Determines the period of inactivity on a global connection before the user is logged out. The idle timeout period can be set to any time span, expressed in minutes.

Session Sleep Timeout

Determines the period of inactivity before the viewer screen will blank and a message is displayed. When no hosts are being viewed either because of this time out or if no viewers are active then parts of the video circuitry are powered down reducing power consumption by up to a third.

Protocol Timeout

Sets the time period by which responses should have been received to outgoing data packets. If the stated period is exceeded, then a connection is considered lost and terminated.

Background Refresh Rate

Use the arrow keys to alter the background refresh rate used to correct any screen changes missed in normal operation. The options are: Slow, Medium, Fast, Auto or Disabled. The Auto option automatically varies the refresh rate when multiple VNC sessions are active to provide a balance between the sessions.

Note: When a low connection speed is detected, the background refresh is automatically disabled, regardless of the settings of this option.

Mouse Latency Allowance

This option is used during calibration to account for latency delays that may be caused as signals pass through a device.

During calibration, the ALIF 21 I2T waits for 40ms after each mouse movement before sampling the next. If a device adds a significant delay to the flow of data, the calibration process can be lengthened or may fail entirely. The value entered here is added to (or subtracted from) the default 40ms sampling time.

Note: You can enter negative values (down to -40) in order to speed up the calibration process when using fast KVM switches. Use this option with caution as it can adversely affect the calibration process.

Mouse Rate

Defines the rate at which mouse movement data are transmitted to the system. The default option is 20ms, which equates to 50 mouse events per second. This is used to slow down the rate in exceptional circumstances but normally requires no adjustment.

Single Mouse Mode Mouse Switch

Select the mouse button combination to exit from single mouse mode (when active).

Use Quick Mouse Calibration

Invokes color calibration techniques that handle the majority of mouse types.

Behaviour for admin connections when limit reached

Determines what should occur when the limit on VNC users is reached. Options are: *Replace oldest connection*, *Replace newest connection* and *Don't replace*. Only non-administrator connections can be terminated in this way.

Enable Virtual Media

When ticked, allows the Adder Virtual Media features to be used.

Reset Unit

Performs a complete cold boot of the ALIF 21 I2T unit.

Time & date configuration

This page allows you to configure all aspects relating to time and date within the unit.

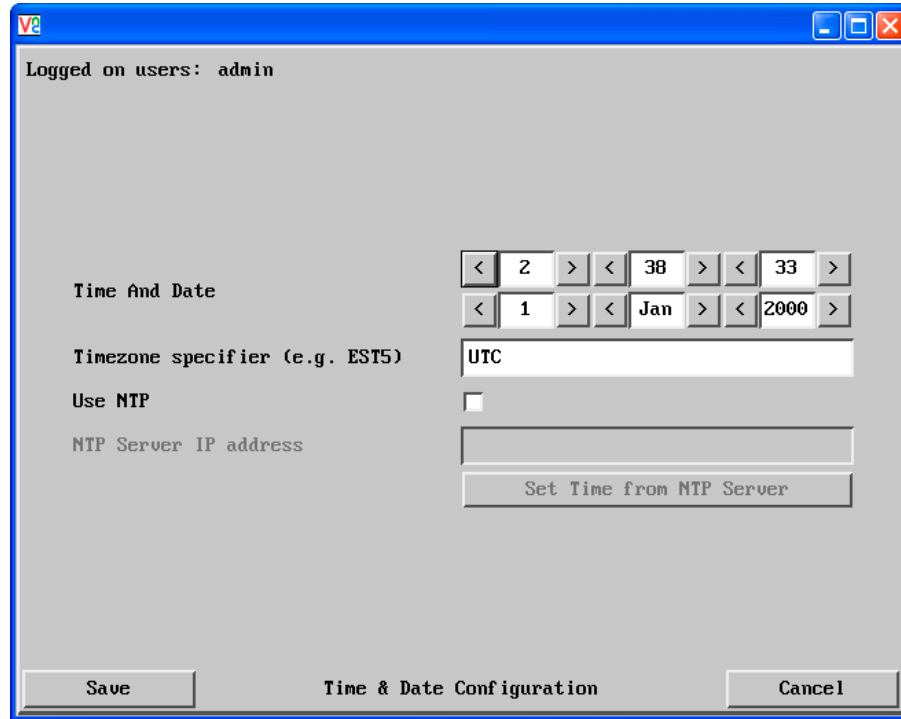

Use NTP

When this option is selected, the ALIF 21 I2T will synchronize its internal clocks using information from the (Network Time Protocol) server listed in the *NTP Server IP address* field.

NTP Server IP address

Optionally enter the IP address for a known Network Time Protocol server.

Set Time from NTP Server

Click to immediately use the time and date information from the listed NTP server.

To get here

- 1 Using VNC viewer or a browser, log on as the 'admin' user.
- 2 Click the 'Configure' button in the top right corner.
- 3 Click the 'Time & Date Configuration' option.

Timezone specifier

Optionally enter a recognized timezone specifier related to the current position of the ALIF 21 I2T unit. When an NTP server is used, the specifier will be used to provide the correct real time.

The timezone specifier takes the following form:

std offset dst [offset], start[/time], end[/time]

The *std* and *offset* specify the standard time zone, such as GMT and 0, or CET and -1, or EST and 5, respectively.

The *dst* string and *[offset]* specify the name and offset for the corresponding Daylight Saving Time zone; if the *offset* is omitted, it defaults to one hour ahead of standard time.

The remainder of the specification describes when Daylight Saving Time is in effect. The *start* field is when Daylight Saving Time goes into effect and the *end* field is when the change is made back to standard time. The most common format used for the daylight saving time is: *mm.w.d*

Where: *m* specifies the month and must be between 1 and 12. The day *d* must be between 0 (Sunday) and 6. The week *w* must be between 1 and 5; week 1 is the first week in which day *d* occurs, and week 5 specifies the *last d* day in the month.

The *time* fields specify when, in the local time currently in effect, the change to the other time occurs. If omitted, the default is 02:00:00.

Typical examples are:

UK:	GMT0BST,M3.5.0/1,M10.5.0/2
Central Europe:	CET-1CEST,M3.5.0/2,M10.5.0/3
US Eastern:	EST5EDT,M3.2.0/2,M11.1.0/2
US Pacific:	PST5PDT,M3.2.0/2,M11.1.0/2

For further details

- For details of timezone specifier formats, please refer to: http://www.gnu.org/software/libc/manual/html_node/TZ-Variable.html
- For details of the Network Time Protocol (main RFC number: 1305; the SNTP subset used as the basis for the ALIF 21 I2T: 4330) <http://www.ietf.org/rfc.html>

Network configuration

This page allows you to configure the various aspects of the IP port.

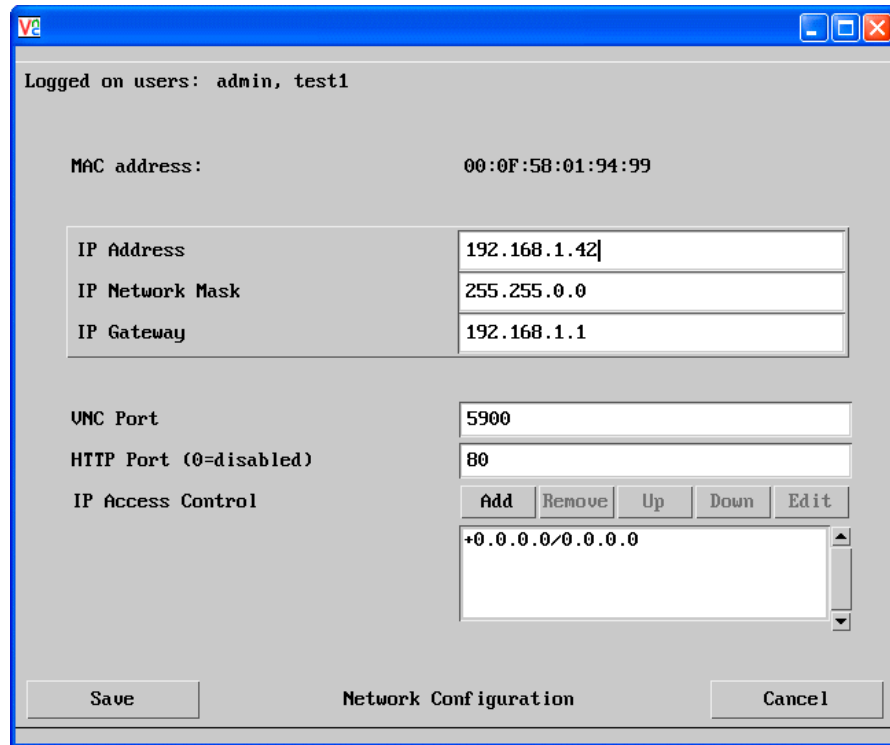

Logged on users: admin, test1

MAC address: 00:0F:58:01:94:99

IP Address	192.168.1.42
IP Network Mask	255.255.0.0
IP Gateway	192.168.1.1

VNC Port: 5900

HTTP Port (0=disabled): 80

IP Access Control: Add Remove Up Down Edit

+0.0.0.0/0.0.0.0

Save Network Configuration Cancel

MAC address

Media Access Control address – this is the unique and unchangeable code that was hard coded within your ALIF 2112T unit when it was built. It consists of six 2-digit hexadecimal (base 16) numbers separated by colons. A section of the MAC address identifies the manufacturer, while the remainder is effectively the unique electronic serial number of your particular unit.

IP Address

This is the identity of the ALIF 2112T within a network. The IP address can be thought of as the telephone number of the ALIF 2112T. Unlike the MAC address, the IP address can be altered to suit the network to which it is connected. It can either be entered manually or configured automatically using the DHCP option. When the DHCP option is enabled, this entry is grayed out.

To get here

- 1 Using VNC viewer or a browser, log on as the 'admin' user.
- 2 Click the 'Configure' button in the top right corner.
- 3 Click the 'Network Configuration' option.

IP Network Mask

Also often called the subnet-mask, this value is used alongside the IP address to help define a smaller collection (or subnet) of devices on a network. In this way a distinction is made between locally connected devices and ones that are reachable elsewhere, such as on the wider Internet. This process helps to reduce overall traffic on the network and hence speed up connections in general.

IP Gateway

This is the address of the device that links the local network (to which the ALIF 2112T is connected) to another network such as the wider Internet. Usually the actual gateway is a network router and it will be used whenever a required address lies outside the current network.

VNC Port

This is the logical link through which communications with a remote VNC viewer will be channelled. The default setting is 5900 which is a widely recognized port number for use by VNC software. However, in certain circumstances it may be advantageous to alter this number - see 'Security issues with ports' for more details.

HTTP Port

This is the logical link through which communications with a remote web browser will be channelled. The default setting of 80 is an established standard for web (HTTP – HyperText Transfer Protocol) traffic though this can be changed to suit your local network requirements.

IP Access Control

This section allows you to optionally specify ranges of addresses which will or won't be granted access to the ALIF 2112T. If this option is left unchanged, then the default entry of '+0.0.0.0/0.0.0.0' ensures that access from all IP addresses will be permitted. See [Setting IP access control](#) for details.

Setting IP access control

The golden rule with this feature is 'Include before you exclude' or to put it another way 'Arrange *allowed* addresses in the list *before* the *denied* addresses'.

This is because the positions of entries in the list are vitally important. Once a range of addresses is denied access, it is not possible to make exceptions for particular addresses within that range. For instance, if the range of addresses from A to F are denied access first, then the address C could not be granted access lower down the list. Address C needs to be placed in the list before the denied range.

IMPORTANT: This feature should be configured with extreme caution as it is possible to deny access to everyone. If such an error occurs, you will need to perform a [reset to factory default settings](#) in order to regain access.

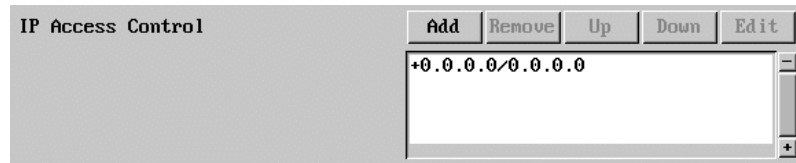

In the list, access control addresses prefixed by '+' are allow entries while those prefixed by '-' are deny entries.

To get here

- 1 Using VNC viewer or a browser, log on as the 'admin' user.
- 2 Click the 'Configure' button in the top right corner.
- 3 Click the 'Network Configuration' option.

To define a new IP access control entry

- 1 Click the Add button to display a popup dialog:



Network/Address

Enter the network address that is to be allowed or denied access. If a range of addresses is being specified then specify any one of the addresses within the range and use the Mask entry to indicate the size of the range.

Mask

Enter an IP network mask that indicates the range of addresses that are to be allowed or denied access. For instance, if only a single specified IP address were to be required, the mask entry would be 255.255.255.255 in order to specify a single location.

Access

Use the arrow buttons to select either 'Allow' or 'Deny' as appropriate.

- 2 Enter the base network address, the mask and select the appropriate access setting.
- 3 Click the OK button.

To reorder access control entries

IMPORTANT: When reordering, ensure that any specific allowed addresses are listed higher in the list than any denied addresses. Take care not to invoke any deny access settings that would exclude valid users.

- 1 In the access control list, click on the entry to be moved.
- 2 Click the Up or Down buttons as appropriate.

To edit/remove access control entries

- 1 In the access control list, click on the appropriate entry.
- 2 Click either the Edit or Remove button as appropriate.

Serial port configuration

This page allows you to configure the baud rate of the ALIF 21 I2T serial port that is used to control power switch devices. A full range of standard baud rates are available.

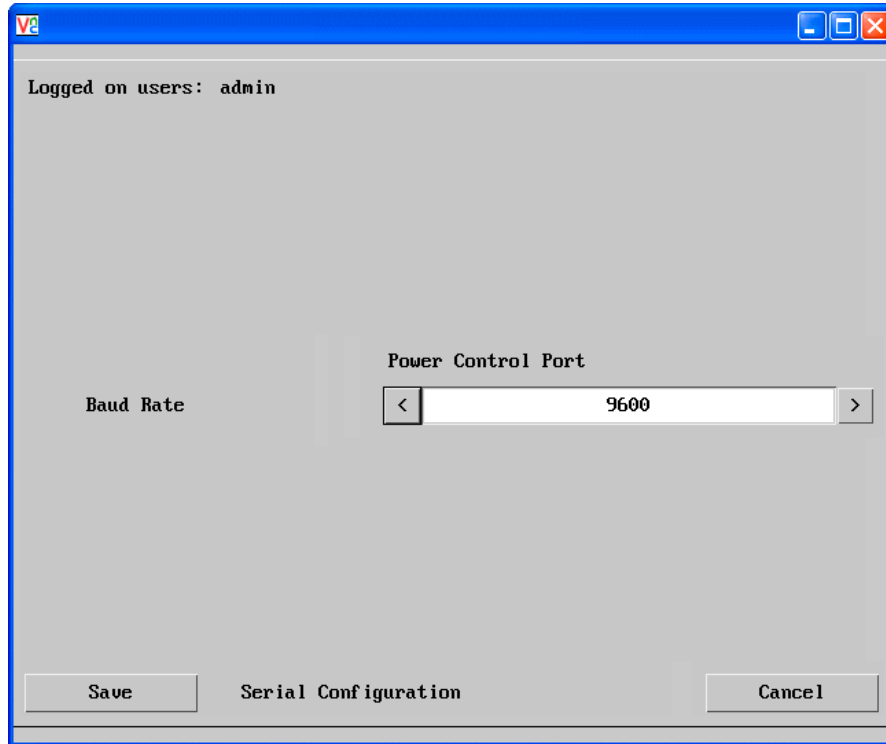

Baud Rate

Determines the communication speed of the OPTIONS port. The other communication settings are fixed as: No parity, 8 bit word, 1 stop bit.

To get here

- 1 Using VNC viewer or a browser, log on as the 'admin' user.
- 2 Click the 'Configure' button in the top right corner.
- 3 Click the 'Serial port Configuration' option.

Host configuration

This page provides the opportunity to configure various details for each of the host systems that may be connected to the ALIF 21 I2T. Each entry can be configured with a name, the permitted users, the hot key combinations required to switch to it and, if required, appropriate power control commands.



Sort

Allows you to reorder the list of hosts either alphabetically or by entry number.

Erase Host Configuration

Removes all hosts from the list.

To get here

- 1 Using VNC viewer or a browser, log on as the 'admin' user.
- 2 Click the 'Configure' button in the top right corner.
- 3 Click the 'Host Configuration' option.

To create a new host entry

- 1 Click one of the host entries to reveal a Host configuration dialog.

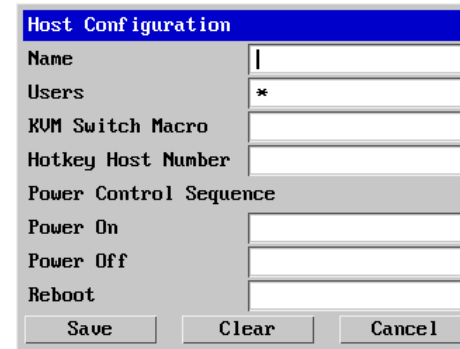

Name

Enter the name that will be displayed in the viewer window when you click the Host button.

Users

Select the users that will be permitted to connect to this host. Either enter * to allow all users or a list of users separated by commas.

KVM Switch Macro

Declare the hot key sequence that will cause the KVM switch to link with the required host system. See [Appendix L - Hotkey sequences](#) for details.

Hotkey Host Number

Declare the numeric sequence that is pressed together with the VNC viewer hotkeys (usually Ctrl + Alt) to select this host system, which is the same value as the KVM port number.

Power On

Enter the code required to make an attached power control unit apply power to the host. See [Power switching configuration](#) for details.

Power Off

Enter the code required to make an attached power control unit remove power from the selected host.

Reboot

Enter the code required to make an attached power control unit remove power and then re-apply it a few seconds later.

- 2 Enter the required information in each field.
- 3 Click the OK button.

Power switching configuration

Power switch configuration comprises two main steps:

- Configure the **OPTIONS** serial port to the same speed as used by the power switch box(es), using the [Serial port configuration menu](#).
- Configure power ON and OFF strings for each relevant host computer.

For each power port there needs to be a valid 'Power ON string' and similarly an appropriate 'Power OFF string'. In each case, the strings are a short sequence of characters that combine a port address and a power on or off value.

If a particular computer has more than one power input (and thus requires an equivalent number of power ports to control them), collections of strings can be combined to switch all of the required ports together as a group.

To configure the power sequences for each host computer

- 1 Using VNC viewer or a browser, log on as the 'admin' user.
- 2 Click the 'Configure' button in the top right corner.
- 3 Click the 'Host configuration' option.
- 4 Click a host entry to display a Host configuration dialog:
- 5 If necessary, configure other parameters (Name, Users, Hot Keys - [MORE](#)).

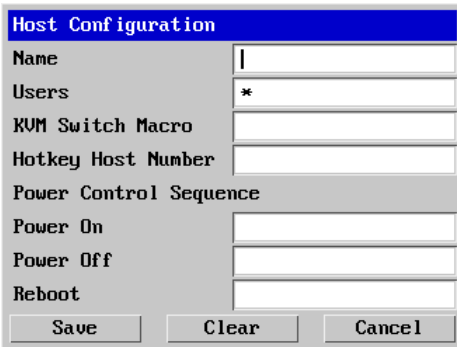

- 6 Enter the **Power control sequences** in the Power On, Power Off and Reboot fields ⇒
- 7 Click OK to close the dialog and then click the Save button in the main Host Configuration window to store the details.

Power control sequences

Notes: The settings given below are for Adder power switches model numbers PSU-8SLAVE and PSU-1GUARD - other power switches may require different settings. Please refer to your power switch documentation for details about codes required by other power switches.

The structure of each power sequence (OFF, ON or Reboot) is as follows:

/Pxy=z\0D

Where:

- x** is the switch box number,
- y** is the power port number,
- z** is '0' for OFF or '1' for ON
- r** is for Reboot, and
- \0D** represents Enter (or Carriage return).

Example 1

To switch ON port 5 of switch box 2, the code would be as follows:

- Power sequence: P25=1\0D

Example 2

To switch OFF port 8 of switch box 3, the code would be as follows:

- Power sequence: P38=0\0D

For details about operating this feature, see [Power switching control](#) within the Configuration chapter.

To control two or more ports simultaneously

You can control up to four power ports using a single sequence. This is done using the same command structure as shown above, plus a delay command, for each port. Immediately following a port command, insert the characters '*' before the next port command, and so on up to four ports. For instance, to switch on ports 1 and 2 in the first power switch, the command line would be:

P11=1\0D*P12=1\0D

Logging and status

This screen provides various details about the user activity on the ALIF 2112T unit.

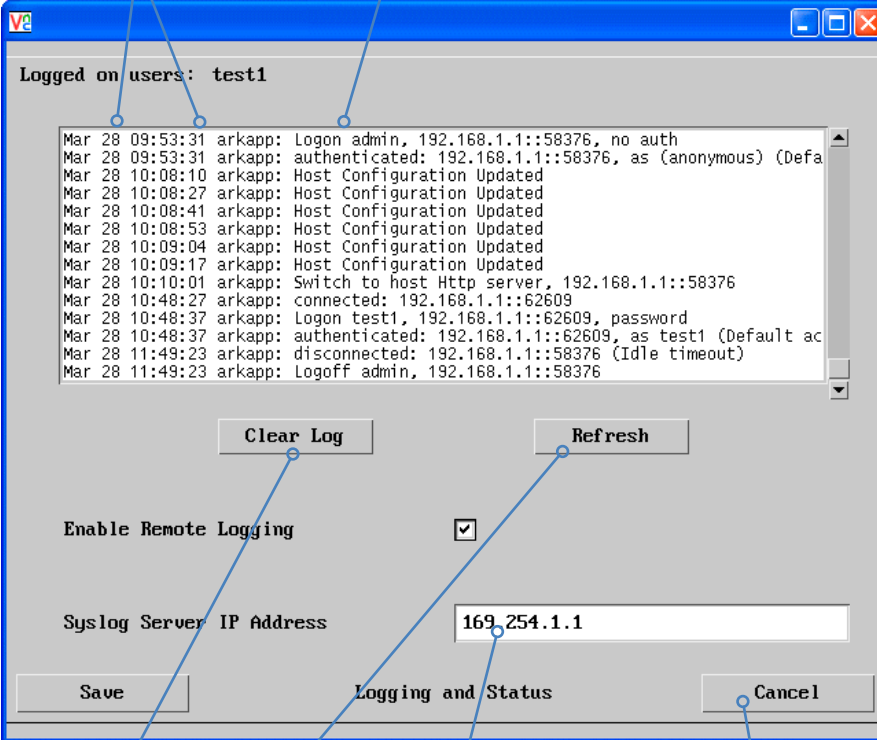

Date and time the event occurred

Type of event, user name and access method or remote IP address

Logged on users: test1

```

Mar 28 09:53:31 arkapp: Logon admin, 192.168.1.1::58376, no auth
Mar 28 09:53:31 arkapp: authenticated: 192.168.1.1::58376, as (anonymous) (Defa
Mar 28 10:08:10 arkapp: Host Configuration Updated
Mar 28 10:08:27 arkapp: Host Configuration Updated
Mar 28 10:08:41 arkapp: Host Configuration Updated
Mar 28 10:08:53 arkapp: Host Configuration Updated
Mar 28 10:09:04 arkapp: Host Configuration Updated
Mar 28 10:09:17 arkapp: Host Configuration Updated
Mar 28 10:10:01 arkapp: Switch to host Http server, 192.168.1.1::58376
Mar 28 10:48:27 arkapp: connected: 192.168.1.1::62609
Mar 28 10:48:37 arkapp: Logon test1, 192.168.1.1::62609, password
Mar 28 10:48:37 arkapp: authenticated: 192.168.1.1::62609, as test1 (Default ac
Mar 28 11:49:23 arkapp: disconnected: 192.168.1.1::58376 (Idle timeout)
Mar 28 11:49:23 arkapp: Logoff admin, 192.168.1.1::58376
  
```

Clear Log

Refresh

Enable Remote Logging

Syslog Server IP Address: 169.254.1.1

Save **Cancel**

Click to clear all log entries

Click to refresh the list

Optionally enter an IP address to which the status log should be sent

Click to return to the main menu

To copy and paste the log

You can copy the information listed within the log and paste it into another application.

- 1 While viewing the log screen, press Ctrl and C, to copy the data into the clipboard.
- 2 In a text application (i.e. Word, WordPad, Notepad) press Ctrl and V, or right mouse click and 'Paste'.

Syslog Server IP Address

Logging information can optionally be sent, as it occurs, to a separate system using the standard Syslog protocol. Enter the IP address of a suitable system in the field provided.

For further details

- For details of the Syslog protocol (RFC number: 3164) <http://www.ietf.org/rfc.html>

To get here

- 1 Using VNC viewer or a browser, log on as the 'admin' user.
- 2 Click the 'Configure' button in the top right corner.
- 3 Click the 'Logging and Status' option.

APPENDIX G - VNC viewer connection options

Note: If you are using a later version of VNC viewer than that provided with the product originally, some menus may differ slightly from those shown here.

When you are connecting to the ALIF 2112T using the VNC viewer, a number of options are available.



Click here to access the options

There are four tabbed pages of options:

- Display
- Inputs
- Connection
- Expert

You can also reduce the four standard tabs to just one that contains only the most commonly used options by clicking the **Basic...** button in the lower left corner. The resulting page includes all of the Display items shown opposite plus the Connection options shown below:

Connection

View-only

When ticked, no control data (from keyboard or mouse) are sent to the ALIF 2112T.

Pass special keys directly to server

When ticked, 'special' keys (the Windows key, the Print Screen key, Alt+Tab, Alt+Escape and Ctrl+Escape) are passed directly to the ALIF 2112T rather than being interpreted locally.

Menu key

This feature allows you to select which function key is used to display the VNC viewer options menu. The menu key is the only way to exit from the full screen viewer mode.

Note: If you make any changes to the options given here and wish to retain them for successive connection sessions, ensure that the option 'Use these settings for all new connections' is ticked.

Display

Scaling

No Scaling

No attempt is made to make the screen image fit the viewer window. You may need to scroll horizontally and/or vertically to view all parts of the screen image.

Scale to Window Size

Adjusts the server screen image to suit the size of the viewer window.

Custom Size

Adjusts the server screen image according to the Width and Height settings in the adjacent fields. A drop box to the right of the fields allows you to define the image size by percentage or by pixels, as required.

Preserve Aspect Ratio

When ticked, maintains a consistent ratio between the horizontal and vertical dimensions of the screen image.

Other options

Full screen mode

When ticked, opens the VNC Viewer in full screen mode.

Enable toolbar

When ticked, the VNC toolbar will be displayed whenever you hover your mouse near the top centre of the VNC window.

Adapt to network speed

When ticked, VNC will automatically adjust the image quality to suit the connection speed. When unticked, a slider allows you to choose the balance manually.

Always use best available colour quality (not in V5 viewers)

When ticked, the VNC Viewer will aim to maximize performance while still maintaining a full color display (even on slower network connections) by affecting other aspects of operation. For instance, by reducing the amount of information sent about the mouse cursor position (which may make the mouse cursor movements appear jerky).

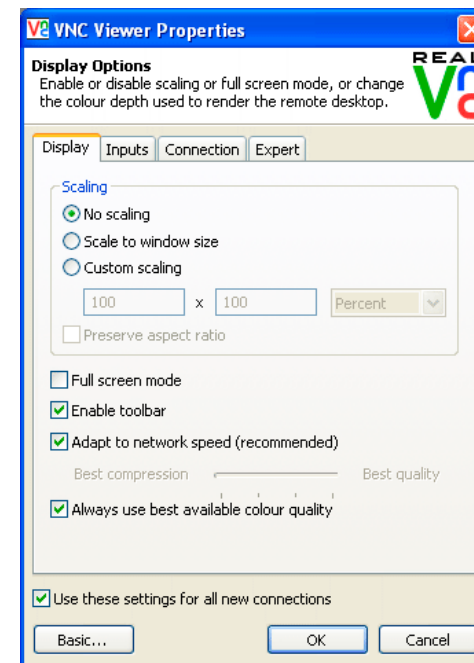

Inputs

Inputs:

When set to 'Enabled', all primary options below are ticked. The 'Disabled' setting unticks all of the primary options (causing 'view-only mode' where no control data may be sent to the ALIF 2112T. The 'Custom' setting is shown if you choose your own combination of options.

Enable keyboard input

Allows keyboard data to be transferred to the ALIF 2112T.

Pass special keys directly to server

When ticked, 'special' keys (the Windows key, the Print Screen key, Alt+Tab, Alt+Escape and Ctrl+Escape) are passed directly to the ALIF 2112T rather than being interpreted locally.

Enable mouse input

Allows mouse data to be transferred to the ALIF 2112T.

Enable 3-button mouse emulation

This feature allows you to use a 2-button mouse to emulate the middle button of a 3-button mouse. When enabled, press the left and right mouse buttons simultaneously to create a middle button action. You are advised to generally use a 3-button mouse.

Rate-limit mouse move events

When ticked, this feature reduces the mouse movement information that is sent to the ALIF 2112T and host system. This is useful for slow connections and you will notice that the remote cursor will catch up with the local cursor roughly once every second.

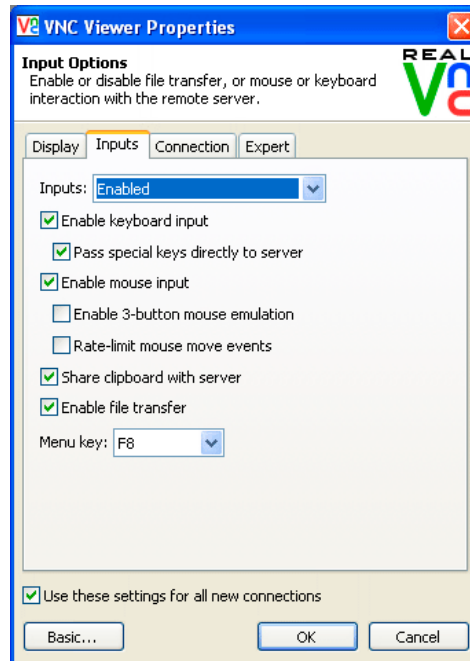

Share clipboard with server

This permits the "Paste Clipboard" operation (see [Keyboard control](#)), and the "Create VM Drive" feature of Virtual Media (see [Virtual Media](#)).

Enable file transfer

This permits the "file transfer" method of Virtual Media (see [Virtual Media](#)).

Menu key

This feature allows you to select which function key is used to display the VNC viewer options menu. The menu key is the only way to exit from the full screen viewer mode.

Connection

The options on this page are not relevant to ALIF 2I I2T connections and should be left in their default states.

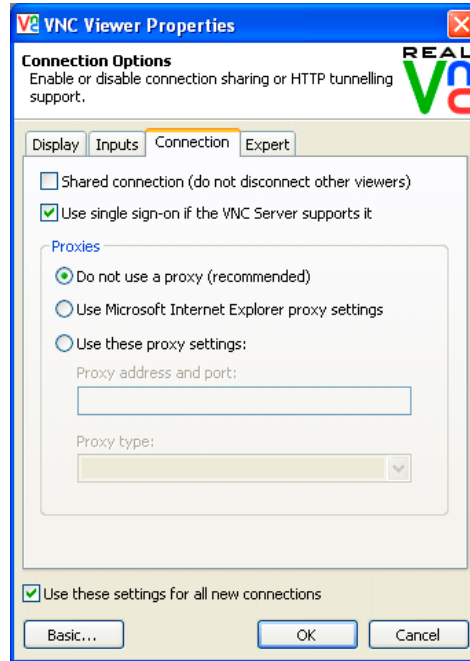

Expert

The options within this section work correctly with ALIF 2I I2T in their default states and should not require alteration except in special circumstances.

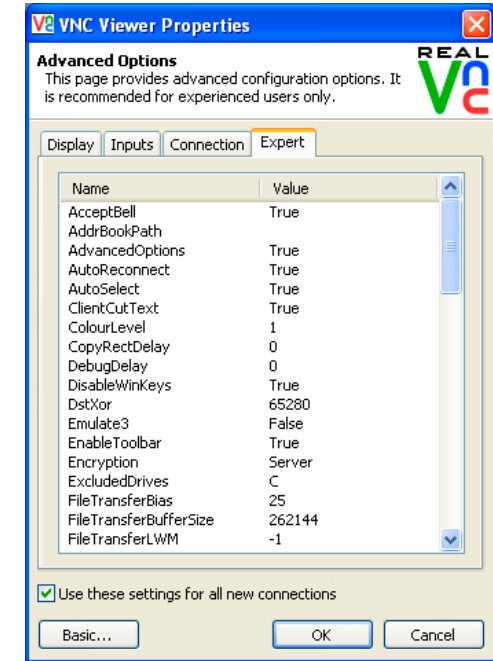

APPENDIX H - VNC viewer window options

Click the VNC icon in the top left corner of the viewer window (or press F8) to display the window options:

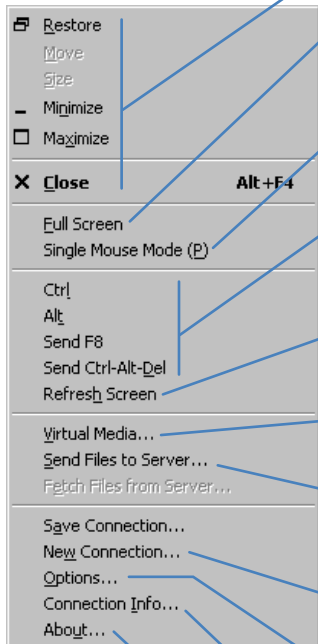

- **Standard window control items**
- **Full screen**
Expands the VNC viewer window to fill the whole screen with no visible window edges or toolbar. Press F8 to re-display this menu.
- **Single mouse mode (P)**
Used for fast network connections where a second, “predictor” cursor is not required.
- **Ctrl,Alt, Send F8, Send Ctrl-Alt-Del**
Sends the selected keypress(es) to the ALIF 21 I2T and host computer. This is necessary because certain keys and key combinations are trapped by the VNC viewer.
- **Refresh Screen**
Requests data from the server for a complete redraw of the screen image, not just the items that change.
- **Virtual Media...**
Allows files to be transferred from the remote computer to the host. See [Virtual Media](#) for details.
- **Send Files to Server...**
Allows files to be transferred from the remote computer to the host. See [Virtual Media](#) for details.
- **New connection...**
Displays the connection dialog so that you can log on to a different ALIF 21 I2T or VNC server location.
- **Options...**
Displays the full range of connection options - see [Appendix G](#) for more details.
- **Connection info...**
Displays various connection and display details.
- **About...**
Displays information about your VNC viewer.

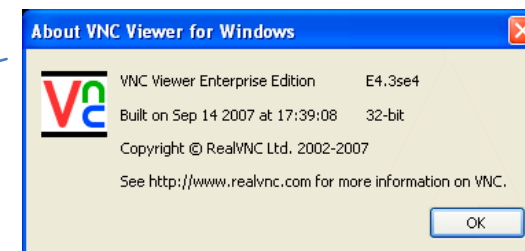
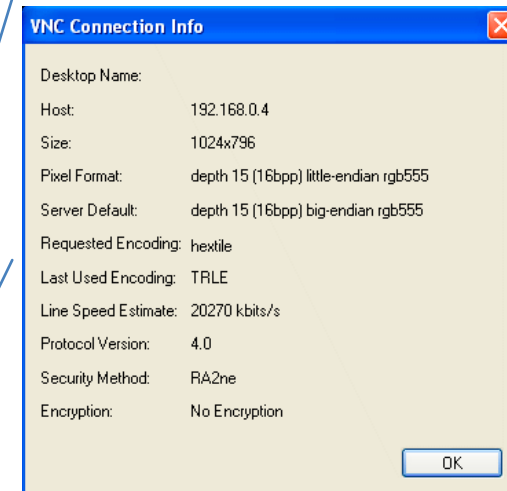
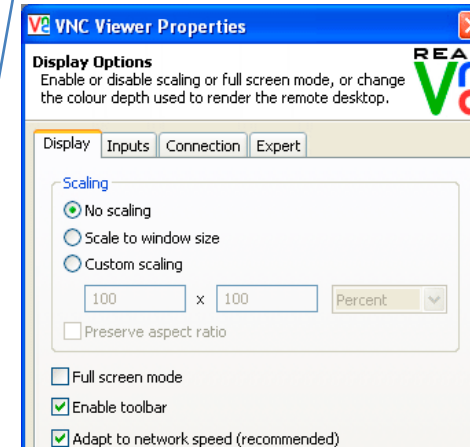
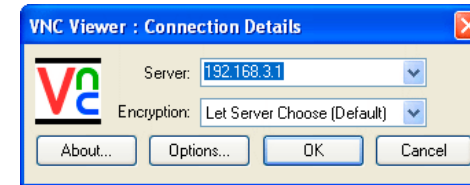

APPENDIX I - Java viewer options

When you are connecting to the ALIF 2112T using the Java viewer, a number of options are available.

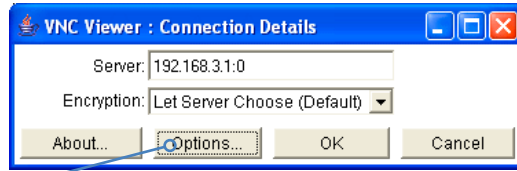

Click here to access the options

There are four options pages:

Encoding and colour level

Auto select

When ticked, this option will examine the speed of your connection to the ALIF 2112T and apply the most suitable encoding method. This option is suggested for the majority of installations.

Preferred encoding

There are three manually selectable encoding methods which are accessible when the Auto select option is unticked.

- **ZRLE** – This is a highly compressed method that is best suited to slow modem connections.
- **Hextile** – This method offers better performance than the ZRLE when used over a high speed network because there is no need for the ALIF 2112T to spend time highly compressing the data.
- **Raw** – This is a primitive, uncompressed method that is mainly used for technical support issues. You are recommended not to use this method.

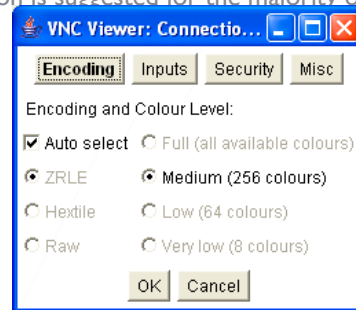

Colour level

The color level is fixed at Medium (256 colors) for almost all browsers.

Inputs

View only (ignore mouse & keyboard)

When ticked, the viewer will not send keyboard or mouse information to the ALIF 2112T or host computer.

Accept clipboard from server

This feature is restricted to software server versions of VNC and has no effect on ALIF 2112T installations.

Send clipboard to server

This feature is restricted to software server versions of VNC and has no effect on ALIF 2112T installations.

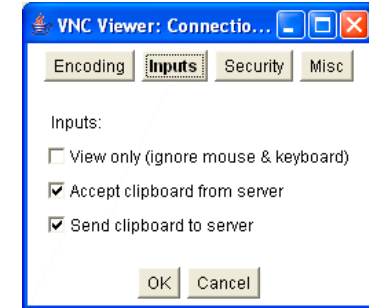

Security

512 bits (low security)

Selects the lowest level of encoding for communications between the browser and the ALIF 2112T.

1024 bits (medium security)

Selects the middle level of encoding for communications between the browser and the ALIF 2112T.

2048 bits (high security)

Selects the highest level of encoding for communications between the browser and the ALIF 2112T.

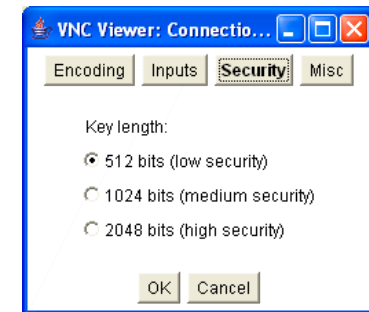

Misc

Shared (don't disconnect other viewers)

This feature is restricted to software server versions of VNC and has no effect on ALIF 2112T installations.

Render cursor locally

This feature is restricted to software server versions of VNC and has no effect on ALIF 2112T installations.

Fast CopyRect

This option should remain enabled.

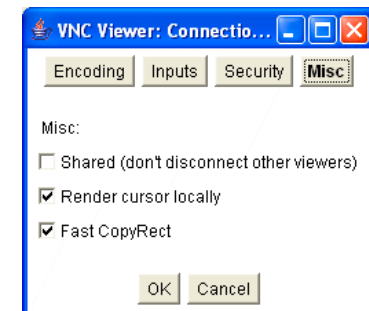

APPENDIX J - The KVMADMIN utility

Particularly useful for complex ALIF 21 I2T configurations and the control of remote installations, KVMADMIN is a powerful administration tool.

KVMADMIN is based upon the established VNC viewer and uses the same security system. Rather than a graphical interface such as the standard viewer, KVMADMIN uses command line control to provide the following administration facilities:

- Discover and adjust the ALIF 21 I2T configuration, including host systems,
- Save and restore the ALIF 21 I2T configuration,
- Set user names and passwords,
- Download the event log,

The use of KVMADMIN is strictly limited to the 'admin' user and for security purposes it is not possible to retrieve user names or passwords from the ALIF 21 I2T.

To use KVMADMIN you require the IP address and admin password of the ALIF 21 I2T unit. The command line is as follows:

```
kvmadmin <command> <ip address> [<parameters>]
```

where <command> is one of the following:

- -setconfig <config-file>
- -getconfig <config-file>
- -setusers <csv-file>
- -getlog <log-file>
- -gethosts <csv-file>
- -sethosts <csv-file>
- -setmodes <csv-file>

For instance, the command line:

```
kvmadmin -getconfig kvm1.cfg 192.168.2.1
```

... downloads the current configuration from the ALIF 21 I2T unit at the given address and stores it in the local file *kvm1.cfg*.

Whereas the command line:

```
kvmadmin -setusers users.csv 192.168.2.1
```

... configures the usernames and passwords for the same unit from the local file *users.csv*.

For more information about KVMADMIN, please refer to the user notes supplied with the utility.

APPENDIX K - Known working video modes

640x480 @ 60Hz
720x480 @ 60Hz
768x576 @ 60Hz
800x480 @ 60Hz
1024x600 @ 60Hz
1024x768 @ 60Hz
1152x768 @ 60Hz
1152x864 @ 60Hz
1280x720 @ 60Hz
1280x768 @ 60Hz
1280x800 @ 60Hz
1280x854 @ 60Hz
1280x960 @ 60Hz
1280x1024 @ 60Hz
1366x768 @ 60Hz
1400x1050 @ 60Hz
1440x900 @ 60Hz
1440x960 @ 60Hz
1600x900 @ 60Hz
1600x1200 @ 60Hz
1680x1050 @ 60Hz
1920x1080 @ 60Hz
1920x1200 @ 60Hz
2048x768 @ 60Hz
2048x1080 @ 60Hz
2048x1152 @ 60Hz
2048x1536 @ 60Hz
2048x2048 @ 60Hz
2560x1440 @ 60Hz
2560x1600 @ 60Hz
2560x2048 @ 50Hz

INSTALLATION

CONFIGURATION

OPERATION

FURTHER
INFORMATION

INDEX

APPENDIX L - Hotkey sequences

ALIF 21 I2T allows you to enter commands suitable for any KVM switch in order to choose from up to 128 host systems. These switching commands can take the form of hotkey sequences that emulate standard keypress combinations.

Hotkey sequences

Almost any combination of keypresses can be emulated using the following notations:

- + means press down the key that follows;
- means release the key that follows
- +− means press and then release the key that follows
- * means add a delay. The standard delay period is 250ms, however, if a number immediately follows the asterisk, this will define an alternate delay period (in milliseconds)

Notes

- The entries are not case sensitive.
- All characters can be entered using their ASCII codes, from 32 to 126 (i.e. A,B,C, ... 1,2,3 etc.) with the exception of the special characters above.
- It is not necessary to specify all keys to be released at the end because they are all released automatically after the last code.
- A number of KVM switches from alternative manufacturers use hot key sequences that begin with a press/release of either the Scroll Lock or Ctrl keys. These often require a delay between the initial key press and the channel number to allow the switch to respond. A 500ms delay is usually sufficient.

Examples

To send the command *Ctrl + Alt 4* you should use the following: `+Ctrl+Alt+4`.

To send the command *Ctrl + Alt 12* you should use the following: `+Ctrl+ALT+−1+2` (the '+−1' entry causes the 1 key to be pressed and released before the 2 key is pressed).

To send the command *Scroll lock 1 + Enter* (with a 500ms delay) you should use the following: `+−Scr*500+1+Ent`

Main control keys (see 'Using abbreviations')

Backspace | Tab | Return | Enter | Ctrl | Alt | Win | Shift | LShift | RShift
LCtrl | RCtrl | LAlt | AltGr | RAlt | LWin | RWin | Menu | Escape | Space
CapsLock | NumLock | PrintScreen | Scrolllock

Math operand keys (see 'Using abbreviations')

Add (Plus) | Subtract (Minus) | Multiply

Central control keys (see 'Using abbreviations')

Insert | Delete | Home | End | PageUp | PageDown
Up | Down | Left | Right | Print | Pause

Keypad keys (see 'Using abbreviations')

KP_Insert | KP_Delete | KP_Home | KP_End | KP_PageUp
KP_PageDown | KP_Up | KP_Down | KP_Left | KP_Right | KP_Enter
KP_Add | KP_Subtract | KP_Divide | KP_Multiply
KP_0 to KP_9

Function keys

F1 | F2 | F3 | F4 | F5 | F6 | F7 | F8 | F9 | F10 | F11 | F12

Creating macro sequences

Hot key macro sequences can be up to 256 characters long. All keys are assumed to be released at the end of a line, however, you can also determine that a key is pressed and released within a sequence. Any of the following three examples will send a command that emulates and a press and release of the Scroll Lock key:

+SCROLL-SCROLL
+-SCROLL
+SCROLL-

Example:

+−SCROLL+−SCROLL+1+ENTER

Press and release scroll twice, press 1 then enter then release all keys (equivalent definition is `+SCROLL-SCROLL+SCROLL-SCROLL+1+ENTER-1-ENTER`)

Using abbreviations

To reduce the length of the key definitions, any unique abbreviation for a key can be used. For example: "scroll", "scr" and even "sc" all provide an identifiable match for "ScrollLock" whereas "en" could not be used because it might mean "Enter" or "End" ("ent" would be suitable for "Enter").

Note: Hotkey sequences and abbreviations are not case sensitive.

For information about where to enter these codes, please see the sections [Host configuration](#) or [Keyboard control](#).

APPENDIX M - Cable pinouts, video modes and general specifications

RS232 'null-modem' cable pin-out

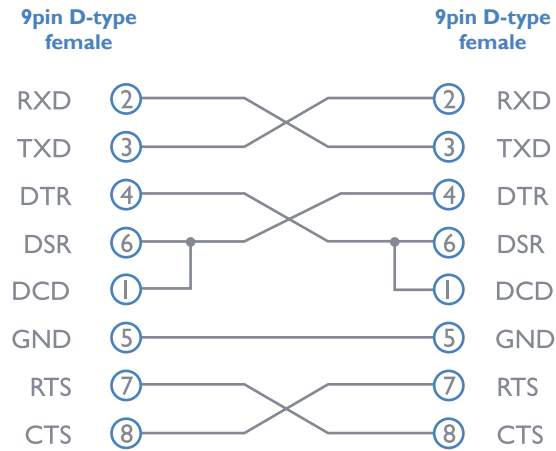

Supported video modes

ALIF dual units support all VESA and CEA video modes.

General specifications

Casing (w x h x d):	198mm (7.92") x 44mm (1.76") x 145mm (5.7")
Construction:	1U compact case, robust metal design
Weight:	1.11kg (2.44lbs)
Mount kits:	Rack mount - single or dual units per 1U slot. VESA monitor / wall mount chassis.
Power to adapter:	100-240VAC 50/60Hz, 0.8A,
Power to unit:	5VDC 20W
Operating temp:	0°C to 40°C (32°F to 104°F)
Approvals:	CE, FCC

APPENDIX N - Fibre modules and cables

To suit your installation layout, two fibre modules are available for the ALIF dual units to suit various fibre optic cables. The specifications for all are summarized in the table below:

Fibre Type	Fibre size	Fibre Type	Coding			Distance at 1Gbps	Adder part number for SFP module	Bar color	Conn. type
			Normal Applications	Military Applications	Suggested Print Nomenclature				
OM1	(62.5/125)	Multimode (TIA-492AAAA)	Orange	Slate	62.5/125	220m	SFP-MM-LC	Black	LC
OM2	(50/125)	Multimode (TIA-492AAAB)	Orange	Orange	50/125	550m	“	“	“
OM3	(50/125)	Multimode (850 nm Laser-optimized) (TIA-492AAAC)	Aqua	Undefined	850 LO 50 /125	550m	“	“	“
OM4	(50/125)	Multimode (850 nm Laser-optimized) (TIA-492AAAC)	Aqua	Undefined	850 LO 50 /125	550m	“	“	“
OS1 and OS2	(9/125)	Single-mode (TIA-492C000 / TIA-492E000)	Yellow	Yellow	SM/NZDS, SM	10Km	SFP-SM-LC	Blue	LC

APPENDIX O - Additional features

New lossless CODEC (AFZ)

The new compression scheme builds on the existing codec and is primarily focused on improving the performance for “natural” images (i.e. photographs and movies). It works in concert with the existing codec and is automatically selected whenever there is a benefit to do so.

The new codec is lossless and is very low latency (a small fraction of a frame delay). It generally achieves 50% improvement (in compression) over the current scheme for any areas of the screen that consist of images, gradients, shadows etc., elements commonly found in modern desktop environments.

To maintain compatibility with non AFZ -enabled transmitters and receivers there is an automatic switching method which will revert back to RLE when an AdderLink Infinity receiver is connected to the AdderLink Infinity dual.

Magic Eye (anti-dither support added)

This feature is enabled by default.

The Magic Eye feature increases performance and reduces network traffic when the AdderLink Infinity dual is used with Apple Macs and other host computers that have dithered video output. It also improves performance if the video source is noisy (e.g. from a VGA-to-DVI converter).

Dithering is a technique used by some graphics cards to improve perceived image quality by continuously varying the color of each pixel slightly. This gives the illusion of more shades of color than the display can really reproduce, and smooths the appearance of gradually shaded areas in images. Unfortunately dithering is an issue for KVM extenders such as AdderLink Infinity dual because it makes the image appear to be changing all the time even when it is static, thus creating much more network data than can be carried by a Gigabit Ethernet. The result is a reduction in video frame rate, which the user sees as slow mouse response.

Magic Eye works by ignoring small variations in the video from frame to frame. It is enabled by default as it is not obvious to the user that his poor mouse behaviour is caused by dithering. In most cases Magic Eye is invisible, but it can produce slight color inaccuracies on the monitor. For full color accuracy, Magic Eye can be disabled for video sources which are not dithered or noisy.

SAFETY INFORMATION

- For use in dry, oil free indoor environments only.
- Warning - live parts contained within power adapter.
- No user serviceable parts within power adapter - do not dismantle.
- Plug the power adapter into a socket outlet close to the module that it is powering.
- Replace the power adapter with a manufacturer approved type only.
- Do not use the power adapter if the power adapter case becomes damaged, cracked or broken or if you suspect that it is not operating properly.
- If you use a power extension cord with the units, make sure the total ampere rating of the devices plugged into the extension cord does not exceed the cord's ampere rating. Also, make sure that the total ampere rating of all the devices plugged into the wall outlet does not exceed the wall outlet's ampere rating.
- Do not attempt to service the units yourself.

WARRANTY

Adder Technology Ltd warrants that this product shall be free from defects in workmanship and materials for a period of two years from the date of original purchase. If the product should fail to operate correctly in normal use during the warranty period, Adder will replace or repair it free of charge. No liability can be accepted for damage due to misuse or circumstances outside Adder's control. Also Adder will not be responsible for any loss, damage or injury arising directly or indirectly from the use of this product. Adder's total liability under the terms of this warranty shall in all circumstances be limited to the replacement value of this product.

If any difficulty is experienced in the installation or use of this product that you are unable to resolve, please contact your supplier.



RADIO FREQUENCY ENERGY

A Category 5 (or better) twisted pair cable must be used to connect the units in order to maintain compliance with radio frequency energy emission regulations and ensure a suitably high level of immunity to electromagnetic disturbances.

All other interface cables used with this equipment must be shielded in order to maintain compliance with radio frequency energy emission regulations and ensure a suitably high level of immunity to electromagnetic disturbances.

European EMC directive 2004/108/EC

This equipment has been tested and found to comply with the limits for a class A computing device in accordance with the specifications in the European standard EN55022. These limits are designed to provide reasonable protection against harmful interference. This equipment generates, uses and can radiate radio frequency energy and if not installed and used in accordance with the instructions may cause harmful interference to radio or television reception. However, there is no guarantee that harmful interference will not occur in a particular installation. If this equipment does cause interference to radio or television reception, which can be determined by turning the equipment on and off, the user is encouraged to correct the interference with one or more of the following measures: (a) Reorient or relocate the receiving antenna. (b) Increase the separation between the equipment and the receiver. (c) Connect the equipment to an outlet on a circuit different from that to which the receiver is connected. (d) Consult the supplier or an experienced radio/TV technician for help.

FCC Compliance Statement (United States)

This equipment generates, uses and can radiate radio frequency energy and if not installed and used properly, that is, in strict accordance with the manufacturer's instructions, may cause interference to radio communication. It has been tested and found to comply with the limits for a class A computing device in accordance with the specifications in Subpart J of part 15 of FCC rules, which are designed to provide reasonable protection against such interference when the equipment is operated in a commercial environment. Operation of this equipment in a residential area may cause interference, in which case the user at his own expense will be required to take whatever measures may be necessary to correct the interference. Changes or modifications not expressly approved by the manufacturer could void the user's authority to operate the equipment.

Canadian Department of Communications RFI statement

This equipment does not exceed the class A limits for radio noise emissions from digital apparatus set out in the radio interference regulations of the Canadian Department of Communications.

Le présent appareil numérique n'émet pas de bruits radioélectriques dépassant les limites applicables aux appareils numériques de la classe A prescrites dans le règlement sur le brouillage radioélectriques publié par le ministère des Communications du Canada.

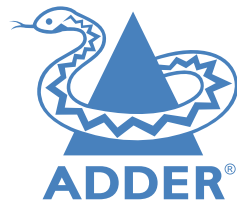

Web: www.adder.com

Contact: www.adder.com/contact-details

Support: forum.adder.com

A

- Access control
 - configuration 52
- Access mode
 - shared & private 33
- Active Copper 12
- Adaptive 44
- Advanced unit configuration 49
- AFZ 67
- Anti-dither support 67
- Auto select 61

B

- Background Refresh 43
- Browser
 - viewer options 30,61
- Browser-based utility 15

C

- Cable
 - null-modem 65
- Cable specifications 64
- CODEC 67
- Colour Depth 43
- Configuration
 - advanced mouse 33
 - browser-based utility 15
 - menu bar edit 37
 - receiver 17
 - styles 2
 - switches 19
 - transmitter 16
- Connections
 - TX audio links 10
 - TX USB link 10
- Controls
 - viewer options 32
- Control strings
 - power switching 55
- Cut-through 44

D

- Dimensions 65
- Dithering 67

F

- Factory reset 14
- Fast-Leave 42
- Fibre Channel 12
- Firmware
 - current version 48
 - upgrade 19
- Forwarding modes 44
- Fragment-free 44
- Frame Skipping 25,43
- Front panel indicators 20
- Full screen mode
 - escape from (F8) 21

G

- Gateway
 - remote setting 51
- Gigabit Ethernet 12
- Gui editing 37

H

- Hextile 61
- Host computer
 - configuration 54
 - power switching setup 55
- Hotkey sequences 64
 - codes and macros 64
- HTTP port
 - remote setting 51

I

- IANA 18
- IGMP 42
 - fast-leave 42
 - querier 42
 - snooping 42
- Indicators 3,20
- Initial configuration 14,30
- IP access control 51,52
- IP address
 - remote setting 51
- IP gateway 51
- IP network mask 51

J

- Jumbo frames (packets) 42

K

- Keyboard codes
 - sending 34
- Keyboard Control 34
- Keyboard layout
 - remote setting 48

L

- Layers 2 and 3 44
- Link cable lengths 12
- Logging 56
- Log on 21,31

M

- MAC address 50,51
- Magic Eye 25,67
- Menu bar editing 37
- Menu key
 - changing 57,58
- Mouse
 - advanced configuration 33
 - control 32
 - resync 32
- Multicast
 - configuration 18

N

- Network configuration 51
- Network layout 38
- Network switch
 - choosing 38
- Null-modem cable
 - pin-out 65

O

- Optimization
 - statistics for 28
- Options switches 19
- OSI model 44

P

- Password
 - remote logon 31
- Peak Bandwidth Limiter 43
- Power strings
 - for switching 55
- Power switching
 - configuration 55
 - control sequences 55
 - on & off select 33
 - user permissions 46
 - via viewer 33
- Private
 - access mode 33

Q

- Querier 42

R

- Rack mounting 6
- Raw 61
- Receiver
 - configuration 17
- Refresh screen 32
- Remote configuration
 - advanced unit configuration 49
 - host configuration 54
 - logging and status 56
 - network configuration 51
 - setting IP access control 52
 - unit configuration 48
 - user accounts 46
- Reset
 - manual 14
- Resync mouse 32

S

- Safety information 68
- Screen
 - best resolution 21
 - navigation 21
 - refresh 32
- Server
 - configuration 54
- SFP module 12
- Shared
 - access mode 33
- Single mouse mode 32
- Slow connections
 - optimizing for 21
- Snooping 42
- Spanning Tree Protocol 43
- Specifications 65
- Statistics
 - graphing 28
- Store and forward 44
- Switch
 - choosing 38
 - configuring 39
- Syslog 56
- System port 12
 - TX settings 24

T

- Teaming port 12
 - TX settings 24
- Threshold setting 34
- Time & date configuration 50
- Transmitter
 - configuration 16
- Troubleshooting 40

U

- Unit Configuration 48
- Unit name
 - remote setting 48
- Upgrade
 - firmware 19
- User accounts 46
- User configuration 46,47
- Username
 - remote logon 31

V

- Video
 - optimization 16
- Video modes 65
- Video settings 33,34,43
- Viewer window 21
 - menu bar editing 37
- VNC port
 - remote setting 51
- VNC viewer
 - connection options 57
 - window options 60

W

- Warranty 68
- Web browser
 - viewer options 30,61
- Weight 65

Z

- ZRLE 61